

FM 3-0

Operations

JUNE 2001

DISTRIBUTION RESTRICTION:

Approved for public release, distribution is unlimited

**HEADQUARTERS
DEPARTMENT OF THE ARMY**

Operations

Contents

	Page
FIGURES	iv
HISTORICAL VIGNETTES	vi
PREFACE	vii
PART ONE THE ENVIRONMENT OF OPERATIONS	
Chapter 1 THE ARMY AND THE ROLE OF LAND POWER	1-2
The Role of the Army.....	1-2
Army Mission Essential Tasks.....	1-4
The Operational Environment.....	1-7
Doctrine and the Army.....	1-14
Full Spectrum Operations.....	1-14
Training for Full Spectrum Operations.....	1-17
Soldiers and Leadership.....	1-17
Chapter 2 UNIFIED ACTION	2-1
The Levels of War	2-2
Conduct of Unified Action	2-6
Considerations for Unified Action	2-19
Chapter 3 STRATEGIC RESPONSIVENESS	3-0
Responsive Army Forces	3-0
Force Projection Operations.....	3-12
PART TWO FOUNDATIONS OF FULL SPECTRUM OPERATIONS	
Chapter 4 FUNDAMENTALS OF FULL SPECTRUM OPERATIONS	4-2
The Elements of Combat Power.....	4-3
The Foundations of Army Operations.....	4-11

Distribution Restriction: Approved for public release; distribution is unlimited.

*This publication supersedes FM 100-5, 14 June 1993.

	The Operational Framework	4-18
	Army Capabilities	4-27
Chapter 5	BATTLE COMMAND	5-1
	The Art of Command.....	5-1
	Visualize, Describe, Direct	5-2
Chapter 6	CONDUCTING FULL SPECTRUM OPERATIONS	6-1
	Plan	6-1
	Prepare	6-6
	Execute	6-9
	Assess.....	6-22
PART THREE	CONDUCTING DECISIVE FULL SPECTRUM OPERATIONS	
Chapter 7	OFFENSIVE OPERATIONS	7-2
	Purposes of Offensive Operations	7-2
	Offensive Operations at the Operational and Tactical Levels of War	7-2
	Characteristics of Offensive Operations	7-4
	Offensive Operations Within the Operational Framework	7-6
	Forms of Maneuver	7-10
	Types of Offensive Operations.....	7-15
	Conducting Offensive Operations	7-23
	The Impact of Technology.....	7-28
Chapter 8	DEFENSIVE OPERATIONS	8-1
	Purposes of Defensive Operations	8-1
	Characteristics of Defensive Operations.....	8-2
	Types of Defensive Operations.....	8-3
	Defensive Operations Within the Operational Framework.....	8-8
	Conducting Defensive Operations	8-12
	The Impact of Technology.....	8-18
Chapter 9	STABILITY OPERATIONS	9-1
	Engagement and Response.....	9-2
	Characteristics of Stability Operations	9-4
	Types of Stability Operations	9-6
	Considerations for Stability Operations	9-14
Chapter 10	SUPPORT OPERATIONS	10-0
	Characteristics of Support Operations	10-0

	Types of Support Operations.....	10-1
	Forms of Support Operations	10-4
	Considerations for Support Operations	10-13
PART FOUR	ENABLING OPERATIONS	
Chapter 11	INFORMATION SUPERIORITY.....	11-2
	Characteristics of Information Superiority.....	11-3
	The Information Environment	11-4
	Contributors to Information Superiority.....	11-5
	Planning and Preparing to Achieve Information Superiority	11-20
	Information Superiority Execution.....	11-22
	The Impact of Technology.....	11-23
Chapter 12	COMBAT SERVICE SUPPORT.....	12-1
	Purpose of Combat Service Support	12-2
	Combat Service Support Characteristics.....	12-3
	Combat Service Support Functions.....	12-4
	Combat Service Support Planning and Preparation.....	12-5
	Combat Service Support Execution.....	12-11
	The Impact of Technology.....	12-19
	SOURCE NOTES.....	Source Notes-1
	GLOSSARY.....	Glossary-1
	BIBLIOGRAPHY	Bibliography-0
	INDEX.....	Index-0

Operations

Contents

	Page
FIGURES	iv
HISTORICAL VIGNETTES	vi
PREFACE	vii
PART ONE	THE ENVIRONMENT OF OPERATIONS
Chapter 1	THE ARMY AND THE ROLE OF LAND POWER 1-2
	The Role of the Army..... 1-2
	Army Mission Essential Tasks..... 1-4
	The Operational Environment..... 1-7
	Doctrine and the Army..... 1-14
	Full Spectrum Operations..... 1-14
	Training for Full Spectrum Operations..... 1-17
	Soldiers and Leadership..... 1-17
Chapter 2	UNIFIED ACTION 2-1
	The Levels of War 2-2
	Conduct of Unified Action 2-6
	Considerations for Unified Action 2-19
Chapter 3	STRATEGIC RESPONSIVENESS 3-0
	Responsive Army Forces 3-0
	Force Projection Operations..... 3-12
PART TWO	FOUNDATIONS OF FULL SPECTRUM OPERATIONS
Chapter 4	FUNDAMENTALS OF FULL SPECTRUM OPERATIONS 4-2
	The Elements of Combat Power..... 4-3
	The Foundations of Army Operations..... 4-11

Distribution Restriction: Approved for public release; distribution is unlimited.

*This publication supersedes FM 100-5, 14 June 1993.

	The Operational Framework	4-18
	Army Capabilities	4-27
Chapter 5	BATTLE COMMAND	5-1
	The Art of Command.....	5-1
	Visualize, Describe, Direct	5-2
Chapter 6	CONDUCTING FULL SPECTRUM OPERATIONS	6-1
	Plan	6-1
	Prepare	6-6
	Execute	6-9
	Assess.....	6-22
PART THREE	CONDUCTING DECISIVE FULL SPECTRUM OPERATIONS	
Chapter 7	OFFENSIVE OPERATIONS	7-2
	Purposes of Offensive Operations	7-2
	Offensive Operations at the Operational and Tactical Levels of War	7-2
	Characteristics of Offensive Operations	7-4
	Offensive Operations Within the Operational Framework	7-6
	Forms of Maneuver	7-10
	Types of Offensive Operations.....	7-15
	Conducting Offensive Operations	7-23
	The Impact of Technology.....	7-28
Chapter 8	DEFENSIVE OPERATIONS	8-1
	Purposes of Defensive Operations	8-1
	Characteristics of Defensive Operations.....	8-2
	Types of Defensive Operations.....	8-3
	Defensive Operations Within the Operational Framework.....	8-8
	Conducting Defensive Operations	8-12
	The Impact of Technology.....	8-18
Chapter 9	STABILITY OPERATIONS	9-1
	Engagement and Response.....	9-2
	Characteristics of Stability Operations	9-4
	Types of Stability Operations	9-6
	Considerations for Stability Operations	9-14
Chapter 10	SUPPORT OPERATIONS	10-0
	Characteristics of Support Operations	10-0

	Types of Support Operations.....	10-1
	Forms of Support Operations	10-4
	Considerations for Support Operations	10-13
PART FOUR	ENABLING OPERATIONS	
Chapter 11	INFORMATION SUPERIORITY.....	11-2
	Characteristics of Information Superiority.....	11-3
	The Information Environment	11-4
	Contributors to Information Superiority.....	11-5
	Planning and Preparing to Achieve Information Superiority	11-20
	Information Superiority Execution.....	11-22
	The Impact of Technology.....	11-23
Chapter 12	COMBAT SERVICE SUPPORT.....	12-1
	Purpose of Combat Service Support	12-2
	Combat Service Support Characteristics.....	12-3
	Combat Service Support Functions.....	12-4
	Combat Service Support Planning and Preparation.....	12-5
	Combat Service Support Execution.....	12-11
	The Impact of Technology.....	12-19
	SOURCE NOTES.....	Source Notes-1
	GLOSSARY.....	Glossary-1
	BIBLIOGRAPHY	Bibliography-0
	INDEX.....	Index-0



**UNITED STATES ARMY
THE CHIEF OF STAFF**

Foreword

On The Army's 226th birthday, we can reflect on a record of distinguished service to our Nation and honor those who have gone before us. Yet, we must also look forward to the challenges of the future as we transform ourselves with confidence in our ability to grow adaptive leaders who will sustain that record of service to our Nation. It is to that end that we publish FM 3-0, our capstone operations doctrine, which describes how Army forces, as part of the joint team, will be responsive and dominant across the full spectrum of operations.

The Army is a doctrine-based institution whose capabilities apply across the range of military operations and spectrum of conflict. That spectrum describes an absolute requirement for land forces in joint, combined, and multinational formations for a variety of missions extending from military engagement to stability and support operations to major wars, including conflicts involving the potential use of weapons of mass destruction. Once forces are engaged anywhere on that spectrum, winning comes from the courage and competence of our soldiers, the excellence of their training, the confidence in their equipment, the soundness of their doctrine, and above all, the quality of their leadership.

Warfighting, and by extension less violent actions, depends on a few "rules of thumb." First, we win on the offense; we must be able to defend well, but you win on the offense. Next, we want to initiate combat on our terms -- at a time, in a place, and with a method of our own choosing -- not our adversary's, our choosing. Third, we want to gain the initiative and retain it -- never surrender it if possible. Fourth, we want to build momentum quickly. And finally, we want to win -- decisively. These rules of thumb require commanders to master transitions, to be adaptive. Transitions -- deployments, the interval between initial operation and sequels, consolidation on the objective, forward passage of lines -- sap operational momentum. Mastering transitions is key to maintaining momentum and winning decisively. This places a high premium on readiness -- well trained Soldiers; adaptive leaders who understand our doctrine; and versatile, agile, and lethal formations.

FM 3-0, *Operations*, discusses how to master those transitions; how to apply combat power, and how to think about operations. In short, it provides a professional intellectual framework for how we operate. FM 3-0 is the continuation of a work in progress. This edition has been shaped by our experiences and experiments since the first post-Cold War FM 100-5 published in 1993 and the duties we foresee for our Nation in this early part of the 21st century. Doctrine is an Army imperative. As such, we all need to read it, understand it, and apply its principles and concepts to our training, leader development, and warfighting execution. This ensures The Army will remain ready to fulfill its nonnegotiable contract with the American people -- to provide the landpower to fight and win the Nation's wars -- decisively.

Soldiers on point for the Nation.

A handwritten signature in black ink, reading "Eric K. Shinseki". The signature is written in a cursive, flowing style.

ERIC K. SHINSEKI
General, United States Army

Figures

Figure	Page
1-1. The Range of Army Operations.....	1-15
1-2. Full Spectrum Operations.....	1-16
2-1. The Levels of War.....	2-3
2-2. The Chain of Command and Control.....	2-10
2-3. Joint Command Relationships and Inherent Responsibilities.....	2-11
2-4. Joint Support Categories.....	2-13
2-5. Considerations for Unified Action.....	2-20
3-1. Force Allocation and Augmentation.....	3-8
3-2. Allocation: Force Refinement.....	3-9
3-3. Staff Tailoring: Task Force Eagle.....	3-10
3-4. The Force Projection Process.....	3-13
3-5. Intermediate Staging Base.....	3-18
4-1. The Fundamentals of Full Spectrum Operations.....	4-3
4-2. The Elements of Combat Power.....	4-4
4-3. Theater Organization.....	4-19
4-4. Contiguous and Noncontiguous Areas of Operations.....	4-20
4-5. Battlespace Components.....	4-21
4-6. Close, Deep, and Rear Areas.....	4-26
4-7. Army Command and Support Relationships and Inherent Responsibilities....	4-28
4-8. Complementary Effects.....	4-29
4-9. Reinforcing Effects.....	4-30
5-1. Visualize, Describe, Direct.....	5-4
5-2. Interior and Exterior Lines of Operations.....	5-8
5-3. Logical Lines of Operations.....	5-9
6-1. The Operations Process.....	6-2
6-2. Linear and Nonlinear Combinations.....	6-14
6-3. Combinations of Contiguous and Noncontiguous Areas of Operations with Linear and Nonlinear Operations.....	6-16
7-1. Operational Framework in the Offense.....	7-7
7-2. Envelopment.....	7-11
7-3. Turning Movement.....	7-12
7-4. Infiltration.....	7-13
7-5. Penetration.....	7-14

7-6. Frontal Attack.....	7-15
8-1. Mobile Defense.....	8-4
8-2. Area Defense.....	8-6
8-3. Operational Framework in the Defense.....	8-9
9-1. The Army Role in Theater Engagement.....	9-2
10-1. Types and Forms of Support Operations.....	10-4
10-2. Domestic Support Operations in Disaster Relief.....	10-5
10-3. Domestic Support Relationships for CBRNE Consequence Management Support.....	10-8
11-1. Information Superiority.....	11-6
11-2. Information Operations and Information Superiority.....	11-7
11-3. Situational Understanding.....	11-16
11-4. Information Superiority and Strategic Responsiveness.....	11-22
12-1. Combat Service Support Reach.....	12-2

Figures

Figure	Page
1-1. The Range of Army Operations.....	1-15
1-2. Full Spectrum Operations.....	1-16
2-1. The Levels of War.....	2-3
2-2. The Chain of Command and Control.....	2-10
2-3. Joint Command Relationships and Inherent Responsibilities.....	2-11
2-4. Joint Support Categories.....	2-13
2-5. Considerations for Unified Action.....	2-20
3-1. Force Allocation and Augmentation.....	3-8
3-2. Allocation: Force Refinement.....	3-9
3-3. Staff Tailoring: Task Force Eagle.....	3-10
3-4. The Force Projection Process.....	3-13
3-5. Intermediate Staging Base.....	3-18
4-1. The Fundamentals of Full Spectrum Operations.....	4-3
4-2. The Elements of Combat Power.....	4-4
4-3. Theater Organization.....	4-19
4-4. Contiguous and Noncontiguous Areas of Operations.....	4-20
4-5. Battlespace Components.....	4-21
4-6. Close, Deep, and Rear Areas.....	4-26
4-7. Army Command and Support Relationships and Inherent Responsibilities....	4-28
4-8. Complementary Effects.....	4-29
4-9. Reinforcing Effects.....	4-30
5-1. Visualize, Describe, Direct.....	5-4
5-2. Interior and Exterior Lines of Operations.....	5-8
5-3. Logical Lines of Operations.....	5-9
6-1. The Operations Process.....	6-2
6-2. Linear and Nonlinear Combinations.....	6-14
6-3. Combinations of Contiguous and Noncontiguous Areas of Operations with Linear and Nonlinear Operations.....	6-16
7-1. Operational Framework in the Offense.....	7-7
7-2. Envelopment.....	7-11
7-3. Turning Movement.....	7-12
7-4. Infiltration.....	7-13
7-5. Penetration.....	7-14

7-6. Frontal Attack.....	7-15
8-1. Mobile Defense.....	8-4
8-2. Area Defense.....	8-6
8-3. Operational Framework in the Defense.....	8-9
9-1. The Army Role in Theater Engagement.....	9-2
10-1. Types and Forms of Support Operations.....	10-4
10-2. Domestic Support Operations in Disaster Relief.....	10-5
10-3. Domestic Support Relationships for CBRNE Consequence Management Support.....	10-8
11-1. Information Superiority.....	11-6
11-2. Information Operations and Information Superiority.....	11-7
11-3. Situational Understanding.....	11-16
11-4. Information Superiority and Strategic Responsiveness.....	11-22
12-1. Combat Service Support Reach.....	12-2

Historical Vignettes

	Page
The Army—A Proud History of Full Spectrum Operations	1-3
Task Force Eagle in Bosnia.....	1-10
Technology Aids Soldiers—Operation Desert Hammer VI.....	1-13
Unified Action in Haiti.....	2-2
Operation Assured Response—An Example of Joint Synergy.....	2-6
Responsive and Agile—Operation Uphold Democracy.....	3-3
Precision and Speed—VII Corps Deploys to Southwest Asia	3-14
Close Combat at Landing Zone X-Ray.....	4-5
Operational Maneuver and Fires—Operation Desert Storm	4-7
Field Discipline—Preventive Medicine in Combat	4-9
Information Modernization—AH-64D Longbow	4-11
Experience and Innovation on Grenada	5-13
Commander’s Intent and Sherman’s “March to the Sea”	5-14
Planning Guidance—Grant and Thomas at Chattanooga	5-15
Change of Plans at Normandy	6-4
Home Station, Predeployment, and Deployment Training	6-8
Surprise—Coup de Main in Panama	7-5
Audacity—Turning Movement at Inchon	7-8
Desert Storm—A Decisive Offensive Operation.....	7-9
Decisive Defensive Operations—Pusan, Korea	8-10
Shaping Defensive Operations—2d SANG Brigade at Khafji.....	8-11
Ongoing Deterrence—Forward Presence in Korea	9-4
Stability Mission at Brcko.....	9-7
Foreign Internal Defense in El Salvador.....	9-10
Conventional Arms Control Operations—Task Force Eagle in Bosnia	9-13
Vietnam—A Case Study in US Military Involvement	9-16
Refugee Processing—A Support Operation.....	10-2
JTF Support Hope—Foreign Humanitarian Assistance in Africa	10-3
JTF Andrew—Disaster Relief in the Continental United States.....	10-6
Measures of Effectiveness—Operation Support Hope.....	10-14
Information Superiority in the Gulf	11-5
Contractor Support—Operations in the Balkans	12-11
Full Spectrum Support—22d Support Command in Southwest Asia	12-12
Leveraging Technology—Real-time CSS.....	12-20

Preface

Army forces are the decisive component of land warfare in joint and multinational operations. Army forces aggressively gain the initiative, build and maintain momentum, and exploit success to control the nature, scope, and tempo of full spectrum operations in war and military operations other than war. Execution of this doctrine requires well-trained soldiers and units fueled with the warrior ethos, the best weapons and equipment available, and the solid leadership of officers and noncommissioned officers of character and competence.

PURPOSE

FM 3-0 establishes the Army's keystone doctrine for full spectrum operations. The doctrine holds warfighting as the Army's primary focus and recognizes that the ability of Army forces to dominate land warfare also provides the ability to dominate any situation in military operations other than war. The foundation of FM 3-0 is built upon global strategic responsiveness for prompt, sustained Army force operations on land as a member of a joint or multinational force.

FM 3-0 is compatible with joint doctrine. It provides overarching doctrinal direction for the conduct of full spectrum operations detailed in other Army manuals. As the Army's principal tool for professional education in the art and the science of war, FM 3-0 presents a stable body of operational doctrine rooted in actual military experience. FM 3-0 provides a foundation for the development of tactics, techniques, and procedures.

SCOPE

FM 3-0 is divided into four parts. Part One (Chapters 1–3) discusses the Army's role in peace, conflict, and war. Part Two (Chapters 4–6) discusses the fundamentals of full spectrum operations, battle command, and the operations process. Part Three (Chapters 7–10) discusses the four types of Army operations: offensive, defensive, stability, and support. Part Four (Chapters 11 and 12) discusses information superiority and combat service support as enabling operations.

APPLICABILITY

FM 3-0 provides operational guidance for commanders and trainers at all echelons and forms the foundation for curricula within the Army Education System. Its audience is broad, from battalion through corps to other operational-level organizations. Officers and senior noncommissioned officers must read and understand FM 3-0.

ADMINISTRATIVE INFORMATION

The proponent for this manual is Headquarters, US Army Training and Doctrine Command (TRADOC). Send comments and recommendations on DA Form 2028 (Recommended Changes to Publications and Blank Forms) to Commander, US Army Combined Arms Center and Fort Leavenworth, Combined Arms Doctrine Directorate, ATTN: ATZL-SWW, US Army Command and General Staff College, 1 Reynolds Road, Fort Leavenworth, KS 66027-1352.

Unless stated otherwise, masculine nouns or pronouns do not refer exclusively to men.

This publication contains copyrighted material.

Cross-references use the new field manual numbering system. The bibliography lists field manuals by new number followed by old number.

The glossary lists most terms used in FM 3-0 that have joint or Army definitions. Terms for which FM 3-0 is the proponent manual (the authority) are indicated with an asterisk. The glossary does not contain these definitions, but lists the numbers of paragraphs where terms are defined. Definitions for which FM 3-0 is the proponent manual are printed in boldface in the text. Other definitions are not printed in boldface. Partial definitions of some terms for which FM 3-0 is not the proponent manual are provided in text boxes. See JP 1-02 for complete joint definitions and FM 1-02 for complete Army definitions.

The glossary contains referents of acronyms and definitions of terms not defined in JP 1-02 and FM 1-02. It does not list acronyms and abbreviations that are included for clarity only and appear one time, nor those that appear only in a figure and are listed in the legend for that figure. Some common abbreviations and acronyms—for example, the abbreviations for military ranks and publications—are not spelled out; refer to the glossary. Since *ARFOR* is a defined term as well as an acronym, it is not spelled out.

Some figures show engagement areas and objectives without names. These control measures are normally given names (see FM 1-02).

ACKNOWLEDGMENTS

The copyright owners listed here have granted permission to reproduce material from their works. Other sources of quotations and material used in examples are listed in the Source Notes.

Excerpts from Dwight D. Eisenhower, *The Papers of Dwight David Eisenhower*, vol. 3, *The War Years*, edited by Alfred D. Chandler Jr. © The Johns Hopkins Press, 1970.

Excerpt from *This Kind of War: A Study in Unpreparedness*, by T. R. Fehrenbach © New York: MacMillan, 1963.

Excerpts from *The Civil War, A Narrative*, vol. 3, *Red River to Appomattox*, by Shelby Foote, © Random House, Incorporated, 1974.

Excerpts from *We Were Soldiers Once...and Young*, by Harold G. Moore and Joseph L. Galloway, © LTG H. G. Moore and Joseph L. Galloway, Random House, Incorporated, 1992.

Excerpts from *War as I Knew It* by General George S. Patton. Copyright © 1947 by Beatrice Patton Walters, Ruth Patton Totten, and George Smith Totten. Copyright © renewed 1975 by Major General George Patton, Ruth Patton Totten, John K. Waters Jr., and George P. Waters. Reprinted by permission of Houghton Mifflin Co. All rights reserved.

Excerpt from *Supplying War: Logistics From Wallenstein to Patton* by Martin Van Creveld, © Cambridge University Press, 1977.

This publication is available on the Reimer Digital Library (ADTDL) at <http://155.217.58.58>.

PART ONE

The Environment of Operations

The Army's deployment is the surest sign of America's commitment to accomplishing any mission that occurs on land.

"The Army Vision," 1999

Part One discusses the Army's role in peace, conflict, and war. Warfighting is the Army's primary focus. The ability to dominate land warfare underscores the effectiveness and credibility of Army forces in full spectrum operations. Army forces are the centerpiece of unified action on land. They are strategically responsive, prepared to conduct prompt and sustained operations as part of joint, multinational, and inter-agency teams.

Chapter 1 describes the Army's role in national defense, the six dimensions of the operational environment, and how Army forces prepare for and operate in that environment. It outlines the Army's mission essential tasks and describes doctrine for full spectrum operations. Finally, it discusses how leaders mold soldiers and units into confident, competent teams through tough, realistic training.

Chapter 2 discusses unified action—the joint, multinational, and interagency aspects of full spectrum operations. It describes the contributions each armed service makes and how Army forces are employed within combatant commands.

Chapter 3 addresses strategic responsiveness and force projection. It discusses the attributes of strategically responsive Army forces and the considerations that complement them. It describes the characteristics of force projection operations and the joint systems that support them. It outlines the different types of entry operations. It concludes with an overview of security during force projection and the use of intermediate staging bases.

Chapter 1

The Army and the Role of Land Power

[Y]ou may fly over a land forever; you may bomb it, atomize it, pulverize it and wipe it clean of life—but if you desire to defend it, protect it, and keep it for civilization, you must do this on the ground, the way the Roman legions did, by putting your young men into the mud.

T. R. Fehrenbach
This Kind of War, 1963

1-1. Army forces are the decisive component of land warfare in joint and multinational operations. The Army organizes, trains, and equips its forces to fight and win the nation's wars and achieve directed national objectives. Fighting and winning the nation's wars is the foundation of Army service—the Army's non-negotiable contract with the American people and its enduring obligation to the nation.

THE ROLE OF THE ARMY

1-2. Because Army forces fight and win the nation's wars, they also deter them. The object of deterrence is the will of state and nonstate political and military leaders. Deterrence establishes in the minds of potential adversaries that their actions will have unacceptable consequences. Today, potential adversaries rely on land-based military and paramilitary forces to retain power, coerce and control their populations, and extend influence beyond their borders. Army forces deter by threatening these means of power retention and population control with the ability to engage in decisive combat and seize and occupy adversary territory. Army forces also deter cross-border aggression through forward presence, forward deployment and prompt, flexible response. Army forces poised for action signal the unquestioned commitment of America to fight and win if deterrence fails.

CONTENTS

The Role of the Army	1-2
Army Mission Essential Tasks.....	1-4
Shape the Security Environment	1-4
Respond Promptly to Crisis	1-5
Mobilize the Army	1-5
Conduct Forcible Entry Operations	1-6
Dominate Land Operations	1-6
Provide Support to Civil Authorities	1-7
The Operational Environment.....	1-8
The Threat Dimension.....	1-8
The Political Dimension.....	1-9
The Unified Action Dimension	1-10
The Land Combat Operations	
Dimension	1-11
The Information Dimension.....	1-12
The Technology Dimension	1-12
Doctrine and the Army.....	1-14
Full Spectrum Operations	1-14
Training for Full Spectrum Operations	1-17
Soldiers and Leadership	1-18

1-3. Deployed, combat-ready Army forces reassure allies as they deter potential enemies. The presence of Army forces usually contributes more to the situation than their potential combat power. Army forces on the ground demonstrate that the US is willing to back the host nation with military power. Historically, that backing brings opportunity for stability, and with it, the potential for economic and political development. The armed forces of the ally and Army forces both benefit directly from the cooperation that continuous contact makes possible.

1-4. The Army's warfighting focus produces a full spectrum force that meets the needs of joint force commanders (JFCs) in war, conflict, and peace. In war, Army forces form the nucleus of the joint force land component—imposing the nation's will on the enemy and causing his collapse. In conflict, Army forces deploy quickly into an area of operations (AO) to deter adversaries and potential enemies from establishing their forces and preclude them from gaining an operational advantage. If deterrence fails, Army forces defeat the enemy, end the conflict on terms that achieve national objectives, and establish self-sustaining postconflict stability. Early movement of Army forces retains initiative and freedom of action by providing JFCs complementary means of conducting decisive offensive operations at times and places of their choosing. If circumstances require, Army forces block an enemy offensive and deliver the counteroffensive blow necessary to win as rapidly as possible. In peace, Army forces train for war. They also help shape the international security environment through peacetime military engagement (PME) activities. Army forces help civil authorities, both at home and abroad, prepare for and respond to natural or manmade disasters as well.

The Army—A Proud History of Full Spectrum Operations

Since 1775, Army forces have deterred, compelled, reassured, and supported in war, conflict, and peace. The Army's history spans over 225 years of service to the nation, domestically and overseas. Army forces have fought 10 wars, from the American Revolution to the Gulf War. They have engaged in expeditions and contingency operations in US territories and projected power around the world. They have performed stability operations in Latin America and the Caribbean and defended friendly countries in Asia and Europe during the Cold War.

Soldiers have been involved in support operations as well. They conducted the Lewis and Clark expedition, supported civil authorities during the San Francisco earthquake, and worked with the Civilian Conservation Corps during the Depression. They have eased human suffering during natural disasters worldwide. More recently, Army forces served or are serving as peacekeepers in the Sinai, Northern Iraq, Rwanda, Haiti, Macedonia, Bosnia, and Kosovo. Today, Army forces help maintain regional stability on the Korean Peninsula and in the Persian Gulf region.

Throughout the nation's history, Army forces have demonstrated that the Army remains the nation's strategic land combat force, a service with the diverse capabilities needed to conduct full spectrum operations—anytime, anywhere.

ARMY MISSION ESSENTIAL TASKS

1-5. The Army's mission essential tasks derive from statutory requirements, operational experience, strategies for employing military forces, and operational requirements of the combatant commanders. They are the operational expression of the Army's core competencies contained in FM 1. Although

these tasks are termed the Army mission essential task list (METL), all Army units develop their own battle focused METLs as described in FM 7-0. To perform the Army METL tasks, the Army continuously integrates doctrine, training, leader development, organization, materiel, and soldiers (DTLOMS) (see AR 71-9; FM 3-100.11).

1-6. The Army METL tasks describe what well-trained, superbly led, and well-equipped soldiers do for the nation. They state what the Army does so the nation can use its military power effectively across the full spectrum of operations in war, conflict, and peace. While focused on the land dimension, Army forces complement other service forces in unified action. The ability of Army forces to perform these tasks generates the credible land power necessary for JFCs to preclude and deter enemy action, win decisively if deterrence fails, and establish a rapid return to sustained postconflict stability. Thus, Army forces expand a JFC's range of military options in full spectrum operations.

Army Mission Essential Tasks

- Shape the security environment
- Respond promptly to crisis
- Mobilize the Army
- Conduct forcible entry operations
- Dominate land operations
- Provide support to civil authorities

Full spectrum operations are the range of operations Army forces conduct in war and military operations other than war.

SHAPE THE SECURITY ENVIRONMENT

1-7. The national security and national military strategies establish an imperative for engagement. The US will remain politically and militarily engaged in the world and will maintain military superiority over potential adversaries. Engagement elevates to mission status the role of the US armed forces in shaping an international environment that promotes and protects US

national security interests, before the threat of conflict arises. Forward basing, forward presence, and force projection enhance the ability of Army forces to engage other nations—their people, governments, and militaries.

1-8. Army forces pursue engagement through overseas presence and PME activities. Army forces conduct PME activities at home and abroad. Through PME, Army forces contribute significantly to promoting regional stability, reducing potential conflicts and threats, and deterring aggression and coercion.

1-9. PME activities are proactive, opportunity-based endeavors conducted at home and abroad to shape the international security environment to favor

Instruments of National Power

- Diplomatic
- Informational
- Military
- Economic

US interests. Most nations maintain armies and paramilitary organizations as their primary military instruments. Through many day-to-day interactions with these forces, Army forces strengthen alliances and coalitions and foster the development of democratic institutions. Working with allies and potential coalition partners, Army forces foster bilateral and multilateral relationships, increase military openness, enhance cooperation, and advance regional conflict prevention and resolution mechanisms.

1-10. Other PME activities are directed at potential adversaries. Those activities reduce the potential for instability and conflict by discouraging arms races, countering the proliferation of weapons of mass destruction (WMD), combatting terrorism, and deterring aggression. The presence of Army forces performing these PME activities provides a visible sign of US commitment to peace and stability.

1-11. By conducting PME activities, Army forces continually help combatant commanders shape their areas of responsibility (AORs). In this context, PME activities are developmental stability operations directed within a combatant commander's theater engagement plan. As such, they are planned and conducted like any other military operation. Army forces, especially Army special operations forces (ARSOF), are well suited for PME missions.

RESPOND PROMPTLY TO CRISIS

1-12. JFCs organize actions in time and space to present the enemy with simultaneous, multidimensional threats—land, air, sea, and space. The strategic responsiveness of Army forces adds dominance of the vital land dimension to the capabilities of joint forces. In today's environment, potential enemies understand the dynamics of dimensional combat. They will attempt to sequence their activities to avoid air and naval strikes, while consolidating their position before significant land forces can defeat them. Responsive Army forces give JFCs the ability to conduct operational and tactical maneuver on land early in the operation. Operational and tactical maneuver provides the basis for Army forces to seize and retain the initiative and dictate the terms of land combat. Prompt response increases the magnitude of the enemy's dilemma exponentially. It allows the JFC to apply US military power in complementary and asymmetric ways. This allows the joint force to quickly build and maintain momentum and win decisively.

1-13. Army forces respond to crises in all environments. They are versatile enough to dominate any situation. Army commanders tailor and train forces to react quickly to any crisis, regardless of its nature or the circumstances.

MOBILIZE THE ARMY

1-14. The Army maintains the ability to mobilize reserve component (Army National Guard and US Army Reserve) forces to meet combatant commanders' contingent needs or the requirements of war or national emergencies. The Army also has the facilities, equipment, systems, procedures, and manpower necessary to generate sustained combat power rapidly and effectively.

1-15. It is impossible to guarantee that active component forces will always be properly configured or sufficiently manned and equipped to meet either

unexpected contingencies or the requirements of sustained land combat. Providing the means to expand the Army ensures that the National Command Authorities (NCA) can confront unforeseen threats to national security. Integrated approaches to DTLOMS ensure that all Army components stand trained and ready for action.

CONDUCT FORCIBLE ENTRY OPERATIONS

1-16. Army forces make it possible for JFCs to seize areas previously denied by the enemy force. Army forces can strike contested areas from the air, land, and sea. They can establish and secure lodgments for projecting follow-on forces and sustaining the joint force. The airborne and air assault capabilities of Army forces allow JFCs to seize airfields or other important facilities, such as WMD production and storage sites. In conjunction with the Navy and other services, Army forces can conduct amphibious operations. Seizure and retention of land areas extends beyond points of entry. It can occur at any point where JFCs need to conduct operational maneuver.

DOMINATE LAND OPERATIONS

1-17. For war to be decisive, its outcome must be conclusive. Army forces today are the preeminent land forces in the world. That preeminence translates into the ability to dominate land operations—the decisive complement to air, sea, and space operations. The threat or use of Army forces is the ultimate means of imposing the nation's will and achieving a lasting outcome. Land operations seize the enemy's territory and resources, destroy his armed forces, and eliminate his means of controlling his population. Only land forces can exercise direct, continuing, discriminate, and comprehensive control over land, people, and resources.

1-18. Ultimately, it is the ability of Army forces to close with and destroy the enemy that allows the Army to dominate land operations. Army forces close with and destroy enemy forces through maneuver and precision direct and indirect fires. An adaptive enemy attempts to lessen the effects of operational fires. However, with their inherent qualities of on-the-ground presence and situational understanding, Army forces make permanent the otherwise temporary effects of fires alone. Domination extends from the certainty in the minds of enemy commanders that close combat with Army forces, backed by superlative US air and naval forces, will have two outcomes—destruction or surrender.

1-19. Sustained land operations establish the conditions required for long-term national objectives. Army forces can conduct sustained, large-scale full spectrum operations throughout the theater of operations. Army forces are inherently durable, self-sustaining, and self-replenishing. This endurance allows them to remain in a theater of operations as long as the NCA require. Faced by an enemy capable of prolonged resistance, Army forces create and maintain conditions that lead to the enemy's ultimate defeat.

1-20. Army operational-level organizations include corps, Army service component commands (ASCCs), numbered armies, and other functional and multifunctional units. These organizations are resourced, trained, and

equipped to dominate opposing land forces, control vast land areas, temporarily govern occupied areas, and control populations and resources. Their capabilities include operational and tactical maneuver and fires; command and control (C2) of Army, joint, and multinational forces; theater air and missile defense; intelligence; military and civil engineering; and combat service support (CSS). In addition, ARSOF add special operations capabilities to joint forces. These capabilities include unconventional warfare, foreign internal defense, information operations (IO), WMD counterproliferation, direct action, special reconnaissance, counterterrorism, civil affairs, and psychological operations.

1-21. Robust combat support and CSS to the joint force make sustained land action possible. Normally, Army forces, through the ASCCs, provide CSS; land-based theater air and missile defense; and nuclear, biological, and chemical defense to support or augment the capabilities of all joint force components. Key Army operational-level support organizations include Army air and missile defense commands (AAMDCs); theater support commands; and transportation (ground and aviation heavy lift), supply, engineer, chemical, finance, medical, intelligence, and personnel units. Each of these can deploy tailorable, early-entry, functional modules. These tailored organizations give Army force commanders the functional expertise and C2 capabilities necessary to provide sustained support to the joint force. If necessary, they expand to provide the support required for each phase of the JFC's campaign.

1-22. The Army also maintains the structure and expertise necessary to develop, acquire, and supply the equipment and supplies for full spectrum operations. In addition to supplying Army forces, the Army manages certain commodities, such as conventional ammunition, for all services. It also maintains the research and development capabilities and linkages to the US industrial base that give Army forces the best equipment in the world.

PROVIDE SUPPORT TO CIVIL AUTHORITIES

1-23. Army forces adapt and tailor their warfighting capabilities to complement and support civil authorities and agencies at home and abroad. In times of need, Army forces provide support and expertise to reinforce or fill critical requirements beyond the immediate capabilities of civil authorities and agencies. The presence of trained and ready Army forces from active and reserve components in the United States contributes to security and defense of the homeland. The Army can rapidly respond to natural or manmade disasters as well as threats to security because it possesses a robust and diverse force structure, maintains a substantial physical presence throughout the US, and has forces based or deployed forward in every theater. Prompt Army assistance to civil authorities is often a decisive element in disaster relief and crisis resolution. Army forces continue sustained support until civil authorities no longer require military assistance.

THE OPERATIONAL ENVIRONMENT

1-24. The operational environment has six dimensions. Each affects how Army forces combine, sequence, and conduct military operations. Commanders tailor forces, employ diverse capabilities, and support different missions to succeed in this complex environment.

Dimensions of the Operational Environment

- Threat
- Political
- Unified action
- Land combat operations
- Information
- Technology

THE THREAT DIMENSION

1-25. The potential for armed conflict between nation-states remains a serious challenge. Despite the best efforts of many, disparities in wealth, technology, and information create unstable conditions among nations. Additionally, the influence of nonstate actors has ever increasing regional and worldwide implications. Nations, nonstate actors, and transnational entities compete in the diplomatic, informational, military and economic arenas of the strategic environment. Rarely are only two sides involved in modern conflicts. More often, one multinational group opposes another similar group with conflicting interests. Even within alliances or coalitions, the different parties have their own purposes.

1-26. Multiple threats to US interests exist. Some are direct, such as a cross-border attack; others are indirect, such as coercion. Some regional powers aspire to dominate their neighbors and have the conventional force capabilities required to do so. Such situations may threaten US vital interests, US allies, or regional stability. Transnational groups conduct a range of activities that threaten US interests and citizens at home and abroad. Such activities include terrorism, illegal drug trading, illicit arms and strategic material trafficking, international organized crime, piracy, and deliberate environmental damage. Additionally, extremism, ethnic disputes, religious rivalries, and human disasters contribute to huge refugee migrations. These further the threat to the environment and a region's stability. Collectively, these transnational threats may adversely affect US interests and possibly result in military involvement.

1-27. In the foreseeable future, most nations will modernize and maintain military capabilities for countering regional threats or seeking opportunities. Military change will incorporate advances in information technology, ballistic and cruise missile capabilities, WMD, and genetic engineering. Potential threats vary from heavy conventional units to adaptive, asymmetric forces structured for local and regional use. Adversaries will seek and obtain technologies that challenge US strengths in information technology, navigation, night vision systems, and precision targeting and strike capabilities. The proliferation of WMD and long-range delivery systems will enable adversaries to threaten US forces at greater ranges with increased lethality and precision.

1-28. Adversaries will develop warfighting doctrine that takes perceived US strengths and vulnerabilities into account. They will try to prevent projection of US forces and control the nature and the tempo of US actions through asymmetric operations and adaptive forces. They will try to counter US air operations and neutralize US technological advantages, such as precision strike

capabilities. Adversaries will adapt to more nonlinear, simultaneous operations conducted throughout the AO. They will use conventional and unconventional means to destroy US national will and the capability to wage war.

1-29. Adversaries will also seek to shape conditions to their advantage. They will try to change the nature of the conflict or use capabilities that they believe difficult for US forces to counter. They will use complex terrain, urban environments, and force dispersal methods—similar to those used by the North Vietnamese, Iraqis and Serbs—to offset US advantages. These methods increase targeting difficulties and may result in US forces wasting precision weapons on relatively unimportant assets. Generally, adversaries will seek to operate against US forces according to these concepts:

- Conduct force-oriented operations. Inflict unacceptable casualties.
- Attempt to control the tempo. Create conditions to defeat US forcible entry operations.
- Transition to a defensive framework that avoids decisive battle, preserves capability, and prolongs the conflict. If US forces deploy, use terrorist tactics and other attacks to erode public support, alliance or coalition cohesion, and the will to fight.
- Use modernized intelligence, surveillance, and reconnaissance (ISR) assets and WMD to conduct sophisticated ambushes. Destroy key operating systems or inflict mass casualties within and outside the theater of operations.
- Use terrain and urban areas to disperse mechanized and armored units. Concentrate and disperse them as opportunities allow. Maneuver forces during periods of reduced exposure to US technology. Use upgraded camouflage and deception capabilities.
- Form coalitions against the US.
- Acquire or modify advanced technology systems to create surprise and limited duration overmatch in specific areas.

Adversaries will continue to seek every opportunity for advantage over US and multinational forces. When countered, they will adapt to the changing conditions and pursue all available options to avoid destruction or defeat. This environment and the wide array of threats present significant challenges. Army forces must simultaneously defeat an adversary while protecting noncombatants and the infrastructure on which they depend.

THE POLITICAL DIMENSION

1-30. The national security strategy defines how the US meets challenges in the complex and dynamic global environment. It establishes broad strategic guidance for advancing US interests through the instruments of national power. The detailed formulation of national strategic policy and direction is beyond the scope of this manual. Nevertheless, the national military strategy, derived from national security policy, forms the basis for all operations in war and military operations other than war (MOOTW) (see JP 1; FM 1).

1-31. The military component of the national security strategy focuses on using military force as an instrument of national power. The NCA combine it with other instruments of national power to preserve, protect, and advance

US interests. Military operations influence, and are influenced by, political direction and the integrated use of other instruments of power. The military objective in war is rapid, decisive victory. The NCA determine how that victory contributes to the overall policy objectives. War makes the most overt use of military force. However, successful military operations in any form require Army force commanders with a clear sense of strategic policy goals and objectives. They must understand how using military force fits into the national security strategy and the desired military conditions required to meet policy objectives. In addition, commanders must be able to clearly and concisely articulate this understanding to the US and international media. All political decisions made during operations have strategic, operational, and tactical implications. Likewise, each strategic, operational, and tactical action directly or indirectly affects the political dimension. Translating political decisions into military missions depends on informed and candid assessments. Army force commanders must articulate the military capabilities and limitations of their forces to the JFC, and when required, directly to the NCA.

Task Force Eagle in Bosnia

Beginning in December 1995, Task Force (TF) Eagle deployed to Bosnia to support a unified action conducted by the North Atlantic Treaty Organization (NATO) under the Dayton Accords. The Army-led task force moved elements from Western Europe to the Balkans by air, rail, and road under severe winter conditions. The force encountered several challenges as it closed into the AO. The area was a former war zone, heavily laden with unexploded munitions and millions of landmines. Armed former warring factions faced each other along battle lines, where a tenuous cease-fire remained in effect. TF Eagle's AO contained forces under the United Nations Protection Force, a situation that required extensive information exchange and coordination before mission transfer to the NATO Implementation Force (IFOR). Adding to the complexity was TF Eagle's multinational composition of 25,000 soldiers representing 11 nations. TF Eagle closed in the theater of operations on 14 February 1996. The credible, overwhelming force coupled with extensive planning, liaison, leadership, and discipline overcame language and cultural barriers to move the former warring factions into designated garrisons. Within one year, IFOR carried out the military provisions of the Dayton Accords and created conditions for implementing their civil provisions.

THE UNIFIED ACTION DIMENSION

1-32. The national military strategy calls for Army forces to act as part of a fully interoperable and integrated joint force. Consequently, the employment of Army forces in campaigns and major operations is viewed from a joint perspective. JFCs synchronize Army force operations with those of other service forces. They exploit Army force capabilities and create an effective joint team.

1-33. Land operations determine the outcome of major theater wars (MTWs). In an MTW, the nation employs large joint and multinational forces in major combat operations to defeat an enemy nation, coalition, or alliance. The Gulf

War of 1991 is an example of an MTW. Army forces are the decisive forces for sustained land combat, war termination, and postwar stability. JFCs normally designate the land component as the supported force during those phases of a campaign. In other phases, they may designate another component as the supported force. In such cases, Army forces support the lead component. During all campaign phases, JFCs synchronize the complementary capabilities of the service components that comprise the joint force. In all cases, JFCs have access to the full complement of versatile Army forces to achieve strategic and operational objectives (see FM 3-100.7).

1-34. Smaller-scale contingencies (SSCs) encompass a wide range of joint and multinational military operations that fall between MTW and PME. While not all-inclusive, Army forces committed to SSCs protect American lives and interests, support political initiatives, facilitate diplomacy, promote fundamental American ideals, or disrupt illegal activities. As in MTWs, the JFC assigns supported and supporting relationships to components of the joint force to best accomplish the mission.

1-35. Army forces work with multinational and interagency partners to accomplish their missions. Ideally, multinational and interagency partners provide cultures, perspectives, and capabilities that reinforce and complement Army strengths and capabilities. Close coordination is the foundation of successful unified action.

THE LAND COMBAT OPERATIONS DIMENSION

1-36. Land combat continues to be the salient feature of conflict. It usually involves destroying or defeating enemy forces or taking land objectives that reduce the enemy's effectiveness or will to fight. Four characteristics distinguish land combat:

- **Scope.** Land combat involves contact with an enemy throughout the depth of an operational area. Forces conduct simultaneous and sequential operations in contiguous and noncontiguous AOs. Commanders maneuver forces to seize and retain key and decisive terrain. They use maneuver, fires, and other elements of combat power to defeat or destroy enemy forces. Land combat normally entails close and continuous contact with noncombatants. Rules of engagement reflect this.
- **Duration.** Land combat is repetitive and continuous. It involves rendering an enemy incapable or unwilling to conduct further action. It may require destroying him.
- **Terrain.** Land combat takes place among a complex variety of natural and manmade features. The complexity of the ground environment contrasts significantly with the relative transparency of air, sea, and space. Plans for land combat must account for the visibility and clutter of the terrain and the effects of weather and climate.
- **Permanence.** Land combat frequently requires seizing or securing ground. With control of the ground comes control of populations and productive capacity. Thus, land combat makes permanent the temporary effects of other operations.

THE INFORMATION DIMENSION

1-37. All military operations take place within an information environment that is largely outside the control of military forces. The information environment is the aggregate of individuals, organizations, and systems that collect, process, store, display, and disseminate information; also included is the information itself (see JP 3-13; FM 3-13). National, international, and nonstate actors use this environment to collect, process, and disseminate information. The media's use of real-time technology affects public opinion, both in the US and abroad, and alters the conduct and perceived legitimacy of military operations. Now, more than ever, every soldier represents America—potentially to a global audience.

1-38. Historically, information superiority has enabled decisive Army force operations. Information superiority enables Army forces to see first, understand the situation more quickly and accurately, and act faster than their adversaries. Derived from the effective synchronization of ISR, information management (IM), and IO, information superiority is an operational advantage that results in friendly forces gaining and retaining the initiative. Effective ISR operations and IM identify the information commanders require, collect it, and get it to them when they need it. Offensive IO degrade an adversary's will to resist and ability to fight while simultaneously denying him relevant friendly force information. Defensive IO protect friendly information and C2 systems. Information superiority means commanders receive accurate, timely information that enables them to make better decisions and act faster than their adversaries. Early attainment of information superiority influences all aspects of Army force operations. For example, sharing accurate, current information between initial-entry and follow-on forces creates the conditions for rapid transition from deployment to employment. Sharing real-time changes in the situation among all elements of a force in contact facilitates synchronization and encourages subordinates to exercise initiative.

THE TECHNOLOGY DIMENSION

1-39. Technology enhances leader, unit, and soldier performance and affects how Army forces conduct (plan, prepare, execute, and continuously assess) full spectrum operations in peace, conflict, and war. For example, commanders and staffs assess capability differences among Army forces along with those of multinational forces when designing plans, preparing forces, and weighing employment options. Quality information provided by advanced communications and ISR capabilities assist commanders in making decisions. Battle command benefits from the ability of modern microprocessors and telecommunications to collect, process, store, display, and disseminate information faster and with greater precision. Technology improves soldier endurance and protection, thereby increasing the potential for mission accomplishment. Army warfighting methods adopt expanded capabilities in lethal and nonlethal weapons, projectiles, propellants, and power sources. Battlefield lethality increases due to changes in target acquisition, armament, and delivery means. Commanders leverage technological advancement in force protection and discriminate use of force in stability operations. They use improved C2, mobility, and CSS in support operations. Enhanced CSS, C2, and IM increase operational reach.

1-40. In any operation, Army forces assume that adversaries possess at least some advanced weaponry. Their weaponry may range from a computer connected to the Internet to WMD. Adversaries may also possess information-based technologies or capabilities, such as satellite imagery, night vision devices, or precision-delivery systems. These can present asymmetric threats to Army forces. The potential for asymmetric threats puts a premium on intelligence preparation of the battlefield (IPB) and the other intelligence tasks, to include situation development and providing indications and warning. Operational success requires identifying enemy capabilities (strengths and vulnerabilities), intentions, and courses of action.

1-41. Fielding technologically advanced systems means that commanders will have to combine the capabilities of units at different modernization levels. For example, digitized forces have advantages—such as precision location, precision fires, and in-transit visibility of equipment, personnel, and stocks—that other forces do not. Digitized forces use fires and maneuver with a precision and tempo that less modernized forces cannot match. Force tailoring creates hybrid forces with dissimilar capabilities and technologies. Additional challenges arise during multinational operations. Technological, organizational, and doctrinal differences require exchanging liaison teams and C2, communications, and intelligence equipment. Integrating Army and multinational forces in a way that synchronizes and maximizes their various capabilities is one aspect of unified action.

Technology Aids Soldiers—Operation Desert Hammer VI

Army force commanders use technology to enhance operations and provide an edge over adversaries. In April 1994, Army aviation and ground forces participated in Operation Desert Hammer VI, an advanced warfighter experiment conducted at the National Training Center (NTC). During the exercise, soldiers of TF 1-70, 194th Separate Armored Brigade conducted simulated combat operations using digital technology that enhanced their capabilities against the NTC opposing force. Army forces used the Dismounted Digital Soldier System to enhance visibility during day and night as well as through obscurants and to radio timely scouting reports to higher headquarters. Tanks employed the Intervehicle Information System to enhance mission planning through shared information and increased situational understanding on the move. TF 1-70 received fire support from Paladin, a digitized field artillery system with the capability to stop, fire accurately, and move quickly. During Desert Hammer VI, Army forces confirmed that, while technology improved their performance, soldiers remain the Army's most important resource.

1-42. The US does not have a monopoly on technology. Just as US forces exploit technology to achieve an operational advantage, so might an enemy force. Never in history has access to advanced technology been so widespread. Even adversaries lacking a research and development capability can purchase remarkably sophisticated systems in the global marketplace. Commanders and staffs should prepare for adversaries who use technology in very sophisticated ways. These ways may differ sharply from the ways that

US forces use similar technologies. Some adversaries may apply new technologies altogether.

1-43. Even with its advantages, the side with superior technology does not always win in land operations; rather, the side that applies combat power more skillfully usually prevails. The skill of soldiers coupled with the effectiveness of leaders decides the outcomes of engagements, battles, and campaigns. This fact does not lessen the positive effects of advanced technologies. It does, however, challenge soldiers and leaders to realize and use the potential of advanced technologies in the conduct of full spectrum operations.

DOCTRINE AND THE ARMY

1-44. Doctrine is the concise expression of how Army forces contribute to unified action in campaigns, major operations, battles, and engagements. While it complements joint doctrine, Army doctrine also describes the Army's approach and contributions to full spectrum operations on land. Army doctrine is authoritative but not prescriptive. Where conflicts between Army and joint doctrine arise, joint doctrine takes precedence.

An *operation* is (1) a military action or the carrying out of a strategic, tactical, service, training, or administrative military mission; (2) the process of carrying on combat, including movement, supply, attack, defense, and maneuvers needed to gain the objectives of any battle or campaign.

1-45. Doctrine touches all aspects of the Army. It facilitates communication among soldiers no matter where they serve, contributes to a shared professional culture, and serves as the basis for curricula in the Army Education System. Army doctrine provides a common language and a common understanding of how Army forces conduct operations. It is rooted in time-tested principles but is forward-looking and adaptable to changing technologies, threats, and missions. Army doctrine is detailed enough to guide operations, yet flexible enough to allow commanders to exercise initiative when dealing with specific tactical and operational situations. To be useful, doctrine must be well known and commonly understood.

1-46. As the Army's keystone operations manual, FM 3-0 provides the principles for conducting operations. It describes the Army's operational-level role of linking tactical operations to strategic aims and how Army forces conduct operations in unified action. FM 3-0 bridges Army and joint operations doctrine. It also links Army operations doctrine with Army tactical doctrine.

FULL SPECTRUM OPERATIONS

1-47. Army doctrine addresses the range of full spectrum operations across the spectrum of conflict (see Figure 1-1). Army commanders at all echelons may combine different types of operations simultaneously and sequentially to accomplish missions in war and MOOTW. For each mission, the JFC and Army component commander determine the emphasis Army forces place on each type of operation. Offensive and defensive operations normally dominate

military operations in war and some SSCs. Stability operations and support operations predominate in MOOTW that include certain SSCs and PME.

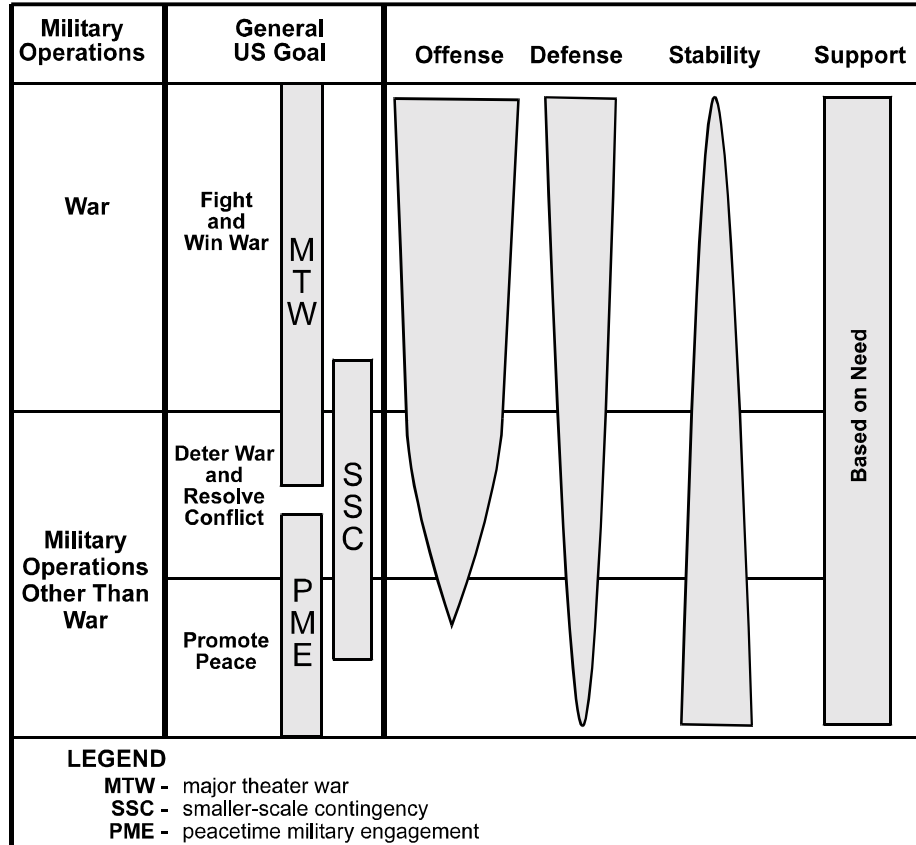

Figure 1-1. The Range of Army Operations

1-48. Full spectrum operations include offensive, defensive, stability, and support operations (see Figure 1-2, page 1-16). Missions in any environment require Army forces prepared to conduct any combination of these operations:

- **Offensive operations** aim at destroying or defeating an enemy. Their purpose is to impose US will on the enemy and achieve decisive victory.
- **Defensive operations** defeat an enemy attack, buy time, economize forces, or develop conditions favorable for offensive operations. Defensive operations alone normally cannot achieve a decision. Their purpose is to create conditions for a counteroffensive that allows Army forces to regain the initiative.
- **Stability operations** promote and protect US national interests by influencing the threat, political, and information dimensions of the operational environment through a combination of peacetime developmental, cooperative activities and coercive actions in response to crisis. Regional security is supported by a balanced approach that enhances regional stability and economic

prosperity simultaneously. Army force presence promotes a stable environment.

- **Support operations** employ Army forces to assist civil authorities, foreign or domestic, as they prepare for or respond to crisis and relieve suffering. Domestically, Army forces respond only when the NCA direct. Army forces operate under the lead federal agency and comply with provisions of US law, to include the Posse Comitatus and Stafford Acts.

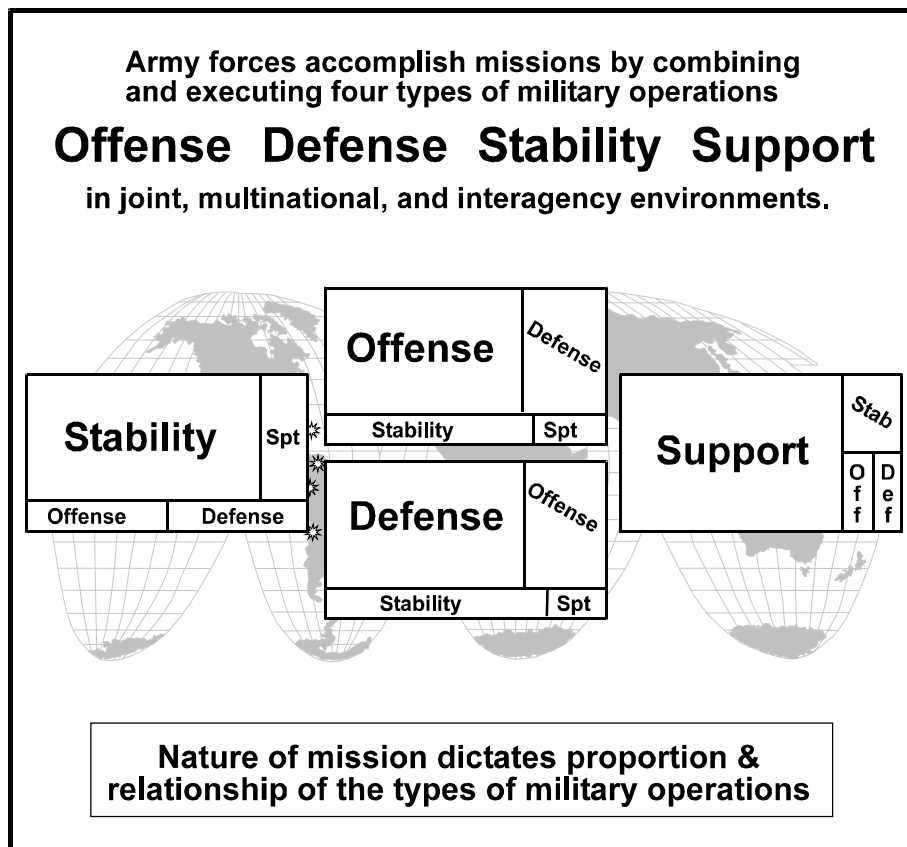

Figure 1-2. Full Spectrum Operations

1-49. When conducting full spectrum operations, commanders combine and sequence offensive, defensive, stability, and support operations to accomplish the mission. The JFC and the Army component commander for a particular mission determine the emphasis Army forces place on each type of operation. Throughout the campaign, offensive, defensive, stability, and support missions occur simultaneously. As missions change from promoting peace to deterring war and from resolving conflict to war itself, the combinations of and transitions between these operations require skillful assessment, planning, preparation, and execution. Operations designed to accomplish more than one strategic purpose may be executed simultaneously, sequentially, or both. For example, within a combatant commander's AOR, one force may be executing large-scale offensive operations while another is conducting stability

operations. Within the combat zone, Army forces may conduct stability operations and support operations as well as combat operations.

1-50. Commanders allocate different proportions of their force to each type of operation during different phases of a mission. Large units are likely to conduct simultaneous offensive, defensive, stability, and support operations. Units at progressively lower echelons receive missions that require fewer combinations. At lower echelons, units usually perform only one type of operation. For example, an Army corps acting as the joint force land component may allocate two divisions to attack (offense) while a third division secures a port and airfield complex (defense). The defending division may order one brigade to eliminate small pockets of resistance (offense) while two others prepare defenses in depth. Around the airfield and port, designated units distribute food and provide medical support to refugees (support). Still other corps units and ARSOF equip and train host nation forces (stability).

TRAINING FOR FULL SPECTRUM OPERATIONS

1-51. Every day, the Army trains soldiers and units while developing leaders. Effective training is the cornerstone of operational success. It is a full-time job for commanders in peacetime and continues when units deploy. Training to high standards is essential for a full spectrum force; Army forces must train to, and maintain, the highest readiness levels. Battle-focused training on combat tasks prepares soldiers, units, and leaders to deploy, fight, and win. More often than not, Army forces execute full spectrum operations as part of a joint force. Joint training is a critical part of mission planning and preparation for Army leaders and units. Upon alert, initial-entry Army forces deploy immediately, conduct operations, and—if necessary—complete any mission-specific training in country. Commanders of follow-on forces conduct pre- or postdeployment mission rehearsal exercises, abbreviated if necessary, based on available time and resources.

The whole of military activity must therefore relate directly or indirectly to the engagement. The end for which a soldier is recruited, clothed, armed, and trained, the whole object of his sleeping, eating, drinking, and marching is simply that he should fight at the right place and the right time.

Clausewitz

1-52. The METL development process describes the links between mission and training (see FM 7-0; FM 7-10). Commanders focus their METL, training time, and resources on combat tasks unless directed otherwise. Because Army forces face diverse threats and mission requirements, commanders may need to temporarily adjust their METL from battle focused tasks to focus on preparing for anticipated missions. Major Army command (MACOM), ASCC, continental US Army, and corps commanders determine the battle focus, resources, and METL that maintain the required readiness posture for anticipated operations in war or MOOTW. MACOM commanders decide for operational-level units, corps commanders for corps units. Commanders at lower levels conduct battle focused training unless otherwise directed.

SOLDIERS AND LEADERSHIP

1-53. Soldiers provide the capability for decisive victory. Success in battle depends on sound doctrine; competent leadership; effective weaponry, equipment, and organizations; and well-trained, motivated, quality soldiers and units. The most important of these factors is soldiers. Their character and competence, combined with the warrior ethos, comprise the foundation of a trained and ready Army. The combination of quality soldiers, competent leaders, and cohesive units creates a versatile, powerful force.

1-54. The Army needs competent and versatile soldiers able to accomplish missions in a challenging and ever changing global environment. They must be able to successfully accomplish tasks while operating alone or in small groups. Soldiers and leaders must exercise mature judgment and initiative under stressful circumstances and be capable of learning and adapting to meet the demands of full spectrum operations.

1-55. Soldiers must also be technically and tactically proficient. They must employ and maintain increasingly complex and sophisticated equipment. Current and future technology requires skilled soldiers who understand their systems. Regardless of the importance of

No man is a leader until his appointment is ratified in the minds and hearts of his men.

Anonymous
The Infantry Journal, 1948

equipment or the expansion of technological capabilities, soldiers are more important than machines. Soldiers, not equipment, accomplish missions and win wars. Leadership links soldiers' technical and tactical competence to operational success. Achieving combined arms effectiveness with complex systems demands adaptive and flexible soldiers.

1-56. The role of the leader and leadership is central to all Army operations (see FM 6-22). Leadership is influencing people—by providing purpose, direction, and motivation—while operating to accomplish the mission and improving the organization. Purpose gives soldiers a reason to do tasks. Direction communicates the way to accomplish the mission. Motivation gives soldiers the will to accomplish the mission. Leadership and the warrior ethos sustain soldiers during the brutal realities of combat and help them cope with the ambiguities of complex military operations.

1-57. Leaders create conditions for success. Organizing, equipping, training, and leading soldiers to accomplish operational missions are the goals of leaders. Will and determination mold soldiers into effective organizations. Full spectrum operations demand Army leaders who are masters of both the art and the science of military operations, and have the training and temperament to adapt to any situation. Success comes from imaginative, flexible, and daring soldiers and leaders.

Chapter 2

Unified Action

[S]eparate ground, sea and air warfare is gone forever. If ever again we should be involved in war, we will fight in all elements, with all services, as one single concentrated effort. Peacetime preparatory and organizational activity must conform to this fact.

President Dwight D. Eisenhower
Special Message to the Congress on Reorganization
of the Defense Establishment, 3 April 1958

2-1. In full spectrum operations, Army forces operate as part of a joint force, often within a multinational and interagency environment. Unified action describes the wide scope of actions (including the synchronization of activities with governmental and nongovernmental agencies) taking place within unified commands, subordinate unified (sub-unified) commands, or joint task forces under the overall direction of the commanders of those commands.

Public law charges combatant commanders with employing military forces through unified action. Under unified action, commanders integrate joint, single-service, special, and supporting operations with interagency, nongovernmental, and multinational—to include United Nations (UN)—operations (see JP 0-2).

2-2. Unified action links subordinates to the combatant commander under combatant command (command authority) (COCOM). Multinational, interagency, and nonmilitary forces work with the combatant commander through cooperation and coordination. Regardless of the task or the nature of the threat, combatant commanders employ air, land, sea, space, and special operations forces, and coordinate with multinational and interagency partners, to achieve strategic and operational objectives. They formulate theater strategies and campaigns, organize joint forces, designate operational areas, and provide strategic guidance and operational focus to subordinates. The aim is to achieve unity of effort among many diverse agencies in a complex environment. Subordinate joint force commanders (JFCs) synchronize joint operations in time and space, direct the action of foreign military forces

CONTENTS

The Levels of War	2-2
The Strategic Level.....	2-2
The Operational Level	2-2
The Tactical Level.....	2-5
Conduct of Unified Action	2-6
Joint Operations	2-6
The Other Armed Forces.....	2-7
Employing Army Forces in Joint Operations.....	2-9
Multinational Operations.....	2-14
Interagency Coordination	2-18
Considerations for Unified Action	2-19
Military Considerations	2-20
Political Considerations.....	2-23
Cultural Considerations.....	2-23

(multinational operations), and coordinate with governmental and nongovernmental organizations (interagency coordination) to achieve the same goal.

Unified Action in Haiti

In September 1994, the US Army's XVIII Airborne Corps participated in Operation Uphold Democracy, a UN-sanctioned operation to return Haiti's deposed president, Jean-Bertrand Aristide, to office. The National Security Council's Haiti Interagency Working Group planned the operation with the UN, Joint Chiefs of Staff, US Atlantic Command, and XVIII Airborne Corps. Together, the agencies and headquarters developed flexible force deployment options that reflected changing political conditions. Army forces with staff augmentation served as Joint Task Forces (JTFs) 180 and 190. On arrival, they stabilized the country until President Aristide's return. JTF 190 worked with the combatant commander, supporting governmental and nongovernmental agencies, joint and multinational forces, and nongovernmental organizations to secure the cities and countryside, disarm the Haitian military, replace the local police, and assist the Haitian people. Army forces then supported the UN by stabilizing the country until elections were held in March 1995.

THE LEVELS OF WAR

2-3. The levels of war are doctrinal perspectives that clarify the links between strategic objectives and tactical actions. Although there are no finite limits or boundaries between them, the three levels are strategic, operational and tactical. Understanding the interdependent relationship of all three helps commanders visualize a logical flow of operations, allocate resources, and assign tasks. Actions within the three levels are not associated with a particular command level, unit size, equipment type, or force or component type. Instead, actions are defined as strategic, operational, or tactical based on their effect or contribution to achieving strategic, operational, or tactical objectives (see Figure 2-1).

THE STRATEGIC LEVEL

2-4. The strategic level is that level at which a nation, often as one of a group of nations, determines national and multinational security objectives and guidance and develops and uses national resources to accomplish them. **Strategy is the art and science of developing and employing armed forces and other instruments of national power in a synchronized fashion to secure national or multinational objectives.** The National Command Authorities (NCA) translate policy into national strategic military objectives. These national strategic objectives facilitate theater strategic planning. Military strategy, derived from policy, is the basis for all operations (see JP 3-0).

THE OPERATIONAL LEVEL

2-5. The operational level of war is the level at which campaigns and major operations are conducted and sustained to accomplish strategic objectives

within theaters or areas of operations (AOs). It links the tactical employment of forces to strategic objectives. The focus at this level is on operational art—the use of military forces to achieve strategic goals through the design, organization, integration, and conduct of theater strategies, campaigns, major operations, and battles. A campaign is a related series of military operations aimed at accomplishing a strategic or operational objective within a given time and space. **A major operation is a series of tactical actions (battles, engagements, strikes) conducted by various combat forces of a single or several services, coordinated in time and place, to accomplish operational, and sometimes strategic objectives in an operational area.** These actions are conducted simultaneously or sequentially under a common plan and are controlled by a single commander. Operational art determines when, where, and for what purpose major forces are employed to influence the enemy disposition before combat. It governs the deployment of those forces, their commitment to or withdrawal from battle, and the

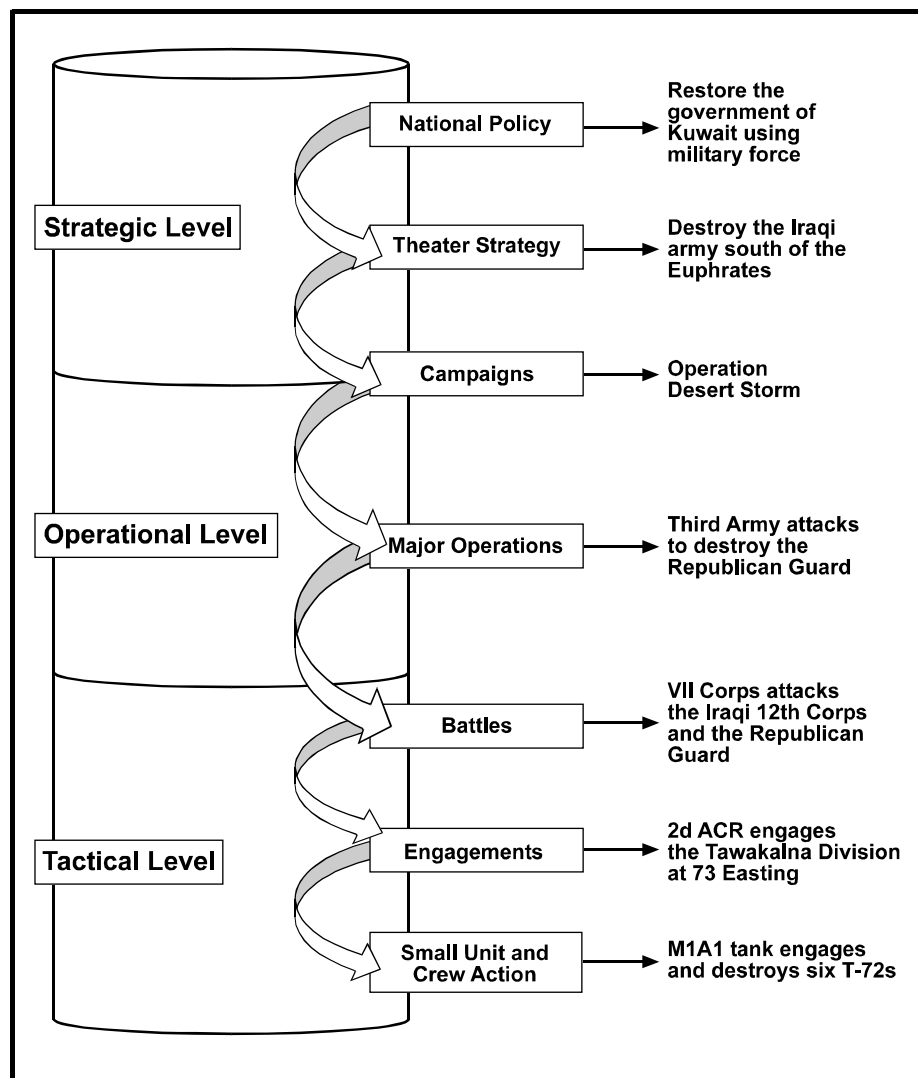

Figure 2-1. The Levels of War

arrangement of battles and major operations to achieve operational and strategic objectives. Figure 2-1 (page 2-3) illustrates the link between the levels of war and the plans and actions of military forces.

2-6. Operational art helps commanders use resources efficiently and effectively to achieve strategic objectives. It includes employing military forces and arranging their efforts in time, space, and purpose. Operational art helps commanders understand the conditions for victory before seeking battle. It provides a framework to assist commanders in ordering their thoughts when designing campaigns and major operations. Without operational art, war would be a set of disconnected engagements with relative attrition the only measure of success. Operational art requires commanders who can visualize, anticipate, create, and seize opportunities. It is practiced not only by JFCs, but also by their senior staff officers and subordinate commanders.

2-7. Operations usually imply broader dimensions of time and space than tactics; the strategic orientation at the operational level requires commanders to look beyond the immediate situation. While tactical commanders fight the current battle, operational commanders look deeper in time, space, and events. They seek to shape the possibilities of upcoming events in advance to create the most favorable conditions possible for subordinate commanders, whose tactical activities execute the campaign. Likewise, operational commanders anticipate the results of battles and engagements, and prepare to exploit them to obtain the greatest strategic advantage.

2-8. Operational commanders continually communicate with their strategic superiors to obtain direction and ensure common understanding of events. Mutual confidence and communications among commanders and staffs allow the flexibility to adapt to tactical circumstances as they develop. Tactical results influence the conduct of campaigns through a complex interaction of operational and tactical dynamics. Operational commanders create the conditions for the conduct of battles and engagements, while the results of battles and engagements shape the conduct of the campaign. In this regard, commanders exploit tactical victories to gain strategic advantage, or even to reverse the strategic effect of tactical losses.

2-9. Operational art is translated into operation plans through operational design. A well-designed plan and successfully executed operation shape the situation for tactical actions. Executed skillfully, a good plan increases the chances of tactical success. It does this by creating advantages for friendly forces and disadvantages for the enemy. A flexible plan gives tactical commanders freedom to seize opportunities or react effectively to unforeseen enemy actions and capabilities. Flexible execution maintains the operational initiative and maximizes tactical opportunities.

2-10. Without tactical success, a campaign cannot achieve its operational goals. An essential element of operational art, therefore, is the ability to recognize what is possible at the tactical level and design a plan that maximizes chances for the success in battles and engagements that ultimately produces the desired operational end state. Without a coherent operational design to link tactical successes, battles and engagements waste precious resources on fights that do not lead to operational goals. A thorough understanding of what is possible tactically, and the ability to create conditions that increase

the chances of tactical success, are important attributes of an operational commander. Tactical commanders must understand the operational context within which battles and engagements are fought as well. This understanding allows them to seize opportunities (both foreseen and unforeseen) that contribute to achieving operational goals or defeating enemy initiatives that threaten those goals. Operational commanders require experience at both the operational and tactical levels. From this experience, they gain the instincts and intuition, as well as the knowledge, that underlie an understanding of the interrelation of tactical and operational possibilities and needs.

2-11. Among many considerations, operational art requires commanders to answer the following questions:

- What military (or related political and social) conditions must be produced in the operational area to achieve the strategic goal (ends)?
- What sequence of actions is most likely to produce that condition (ways)?
- How should resources be applied to accomplish that sequence of actions (means)?
- What are the likely costs or risks in performing that sequence of actions (risk management)?

THE TACTICAL LEVEL

2-12. ***Tactics*** is the employment of units in combat. It includes the ordered arrangement and maneuver of units in relation to each other, the terrain, and the enemy to translate potential combat power into victorious battles and engagements. A ***battle*** consists of a set of related engagements that last longer and involve larger forces than an engagement. Battles can affect the course of a campaign or major operation. An ***engagement*** is a small tactical conflict between opposing maneuver forces, usually conducted at brigade level and below. Engagements are usually short—minutes, hours, or a day (see FM 3-90).

2-13. Tactics is also the realm of close combat, where friendly forces are in immediate contact and use direct and indirect fires to defeat or destroy enemy forces and to seize or retain ground. Exposure to close combat separates Army forces from most of their counterparts. Army forces fight until the purpose of the operation is accomplished. Because of this, they are organized to endure losses, provided with combat service support (CSS) to generate and sustain combat power, and trained to deal with uncertainty.

2-14. The operational-level headquarters sets the terms of battle and provides resources for tactical operations. Tactical success is measured by the contribution of an action to the achievement of operationally significant results. Battles and engagements that do not contribute to the campaign objectives, directly or indirectly, are avoided. Figure 2-1 (page 2-3) illustrates the linkages among the levels of war using military actions in the Gulf War of 1991. The strategic guidance issued by the president translated into orders and actions that led to the staff sergeant tank commander engaging Iraqi tanks in the middle of the night. The destruction of the Iraqi tanks in turn enabled the coalition to restore the Kuwaiti government.

Operation Assured Response—An Example of Joint Synergy

During the 1996 Operation Assured Response in Liberia, forces from the Republic of Georgia, Italy, and Germany joined with US special operations, Air Force, Navy, and Marine forces to conduct a noncombatant evacuation operation. In early April 1996, gunmen had filled the streets of Monrovia, Liberia, as the country split into armed factions intent on seizing power. The situation worsened as faction members took hostages. On 9 April, President Clinton ordered the US military to evacuate American personnel and designated third-party foreign nationals. The Army deployed Special Forces, an airborne company, signal augmentation and a medical section as part of a special operations task force from Special Operations Command–Europe. Army forces entered Monrovia's Mamba Point embassy district, where they established security for international relief agencies headquartered there. Additional Army forces reinforced the Marine guards at the American embassy and secured the central evacuee assembly collection point. Upon securing the evacuees, Navy helicopters took them to Sierra Leone. The combined capabilities of Army forces, other services, and multinational troops demonstrated joint synergy and resulted in the successful evacuation of individuals from 73 countries.

CONDUCT OF UNIFIED ACTION

2-15. In unified action, Army forces synchronize their actions with those of other participants to achieve unity of effort and accomplish the combatant commander's objectives. The capabilities of joint, multinational, and inter-agency partners can expand strengths, compensate for limitations, and provide operational and tactical depth to Army forces.

JOINT OPERATIONS

2-16. Joint operations involve forces of two or more services under a single commander. Land operations and joint operations are mutually enabling—land operations are inherently joint operations. Joint integration allows JFCs to attack an opponent throughout the depth of their AO, seize the initiative, maintain momentum, and exploit success. Effective joint integration does not require joint commands at all

Unless limited by the establishing directive, the commander of the supported force will have the authority to exercise general direction of the supporting effort. General direction includes the designation and prioritization of targets or objectives, timing and duration of the supporting action, and other instructions necessary for coordination and efficiency.

JP 0-2

echelons, but does require understanding joint synergy at all levels of command. Joint synergy extends the concept of combined arms synergy familiar to soldiers. The strengths of each service component combine to overcome the limitations or reinforce the effects of the other components. The combination of multiple and diverse joint force capabilities creates military power more potent than the sum of its parts.

2-17. JFCs often establish supported and supporting relationships among components. They may change these relationships between phases of the campaign or major operation or between tasks within phases. Each subordinate element of the joint force can support or be supported by other elements. For example, the Navy component commander or joint force maritime component commander (JFMCC) is normally the supported commander for sea control operations; the joint force air component commander (JFACC) is normally the supported commander for counterair operations. Army forces may be the supporting force during certain phases of the campaign and become the supported force in other phases. Inside JFC-assigned AOs, the land and naval force commanders are the supported commanders and synchronize maneuver, fires, and interdiction.

THE OTHER ARMED FORCES

2-18. Through Title 10, US Code (USC), and DODD 5100.1, Congress has organized the national defense and defined the function of each armed service. All US armed forces—Army, Air Force, Navy, Marine Corps, Coast Guard—and special operations forces (SOF) are required to provide globally responsive assets to support combatant commanders' theater strategies and the national security strategy. The capabilities of the other armed forces complement those of Army forces. During joint operations, they provide support consistent with JFC-directed missions.

Air Force

2-19. Air Force air platform support is invaluable in creating the conditions for success before and during land operations. Support of the land force commander's concept for ground operations is an essential and integral part of each phase of the operation. Air Force strategic and intratheater airlift, directed by US Transportation Command, supports the movement of Army forces, especially initial-entry forces, into an AO. Air assets move Army forces between and within theaters to support JFC objectives. Fires from Air Force systems create the conditions for decisive land operations. In addition, the Air Force provides a variety of information-related functions—to include intelligence, surveillance, and reconnaissance—that support land operations.

2-20. Support from Army forces made available to the JFACC for tasking—including Army aviation, air defense, military intelligence, and field artillery—is invaluable in accomplishing portions of the counterair, interdiction, theater reconnaissance, and surveillance missions. Such missions may support operations directed by the land component commander or JFC. The effectiveness of air interdiction and close air support depends, to a large degree, on integrating land maneuver with the joint force concept of operations. Land force commanders understand that defeating enemy air and space capabilities is necessary to ensure freedom of action on the ground.

Navy and Marine Corps

2-21. The Navy and Marine Corps conduct operations in oceans and littoral (coastal) regions. The Navy's two basic functions are sea control operations and maritime power projection. Sea control connotes uninhibited use of

designated sea areas and the associated airspace and underwater volume. It affords Army forces uninhibited transit to any trouble spot in the world.

2-22. Maritime power projection covers a broad spectrum of offensive naval operations. Those most important to Army force operations include employment of carrier-based aircraft, lodgment by amphibious assault or maritime pre-positioned deployment, and naval bombardment with guns and missiles. Naval forces establish and protect the sea routes that form strategic lines of communications for land forces. The Navy provides strategic sealift vital for deploying Army forces. Army forces cannot conduct sustained land operations unless the Navy controls the sea. Additionally, naval forces augment theater aerospace assets and provide complementary amphibious entry capabilities.

2-23. The Marine Corps, with its expeditionary character and potent forcible entry capabilities, complements the other services with its ability to react rapidly and seize bases suitable for force projection. The Marine Corps often provides powerful air and ground capabilities that complement or reinforce those of Army forces. When coordinated under a joint force land component commander (JFLCC), Army and Marine forces provide a highly flexible force capable of decisive land operations in any environment.

Coast Guard

2-24. The Coast Guard is an armed force under the Department of Transportation. It has a statutory civil law enforcement mission and authority. Army forces support Coast Guard forces, especially during counterdrug interdiction and seizure operations. When directed by the president or upon a formal declaration of war, the Coast Guard becomes a specialized service under the Navy. The Coast Guard and Navy cooperate in naval coastal warfare missions during peace, conflict, and war. During deployment and redeployment operations, the Coast Guard supports force projection. It protects military shipping at seaports of embarkation and debarkation in the US and overseas. The Coast Guard supports JFCs with port security units and patrol craft.

Special Operations Forces

2-25. SOF provide flexible, rapidly deployable capabilities that are useful across the range of military operations. SOF can reinforce, augment, and complement conventional forces. They can also conduct independent operations in situations that demand a small, discrete, highly trained force. SOF provide the NCA and combatant commanders with options that limit the risk of escalation that might otherwise accompany the commitment of larger conventional forces. In war, SOF normally support the theater campaign or major operations of the JFC. In military operations other than war (MOOTW), SOF support combatant commander theater engagement plans, often directly supporting a US ambassador. Combatant commanders establish or designate operational command and support relationships for SOF based on mission requirements.

Army Special Operations Forces

- Special Forces
- Rangers
- Special operations aviation
- Civil affairs
- Psychological operations
- Signal units
- CSS units

2-26. Land force commanders frequently require Army special operations forces (ARSOF) assets. ARSOF can conduct diverse missions and are a valuable combat multiplier for land operations (see FM 3-05). For example, psychological operations units can fuse the capabilities of US government departments and agencies to counter adversary propaganda, misinformation and disinformation. SOF language capabilities and regional and cultural skills are also useful in stability operations and support operations.

EMPLOYING ARMY FORCES IN JOINT OPERATIONS

2-27. Joint doctrine describes the employment of US forces in joint operations. Army force commanders are always either subordinate to or designated as a JFC. Understanding the command and control (C2) relationships among the components of a joint force is the key to effective joint operations.

Army Forces in Unified Commands

2-28. Except for forces exempted by the secretary of defense, military departments *assign* all forces, to include nonfederalized Army National Guard and unmobilized US Army Reserve forces, under COCOM of combatant commanders (see JP 0-2). The Joint Strategic Capabilities Plan (JSCP) *apportions* major Army forces by type to combatant commanders for deliberate planning. In addition to forces assigned in peacetime, Army forces are *allocated* to combatant commanders in response to crises. The secretary of defense, through the chairman of the Joint Chiefs of Staff, directs other combatant commanders to reinforce the supported combatant commander with *augmentation forces*.

Assigned forces are those forces that have been placed under the combatant command (command authority) of a unified commander by the secretary of defense. Forces and resources so assigned are available for normal peacetime operations of that command.

Apportioned forces and resources are those made available for deliberate planning as of a certain date. They may include assigned, those expected through mobilization, and those programmed.

Allocated forces and resources are those provided by the NCA for execution planning or actual implementation.

Augmentation forces are forces to be transferred from a supporting commander to the combatant command (command authority) or operational control of a supported commander during the execution of an operation order approved by the NCA.

Chain of Command

2-29. The NCA exercise authority and control of the armed forces through a single chain of command with two branches (see Figure 2-2, page 2-10). One branch goes from the NCA to combatant commanders to the service component commands and subordinate joint commands. It is for the conduct of operations and support. The other branch goes from the NCA to the military

departments to their respective major service commands. An administrative control relationship exists between the secretary of the military department and the respective service component commands. It is for carrying out the military departments' Title 10 responsibilities of recruiting, manning, equipping, training, and providing service forces to the combatant commanders. Although the service branch of the chain of command is distinct from the operating branch, both the Army service component command (ASCC) and the ARFOR operate within the combatant commander's chain of command.

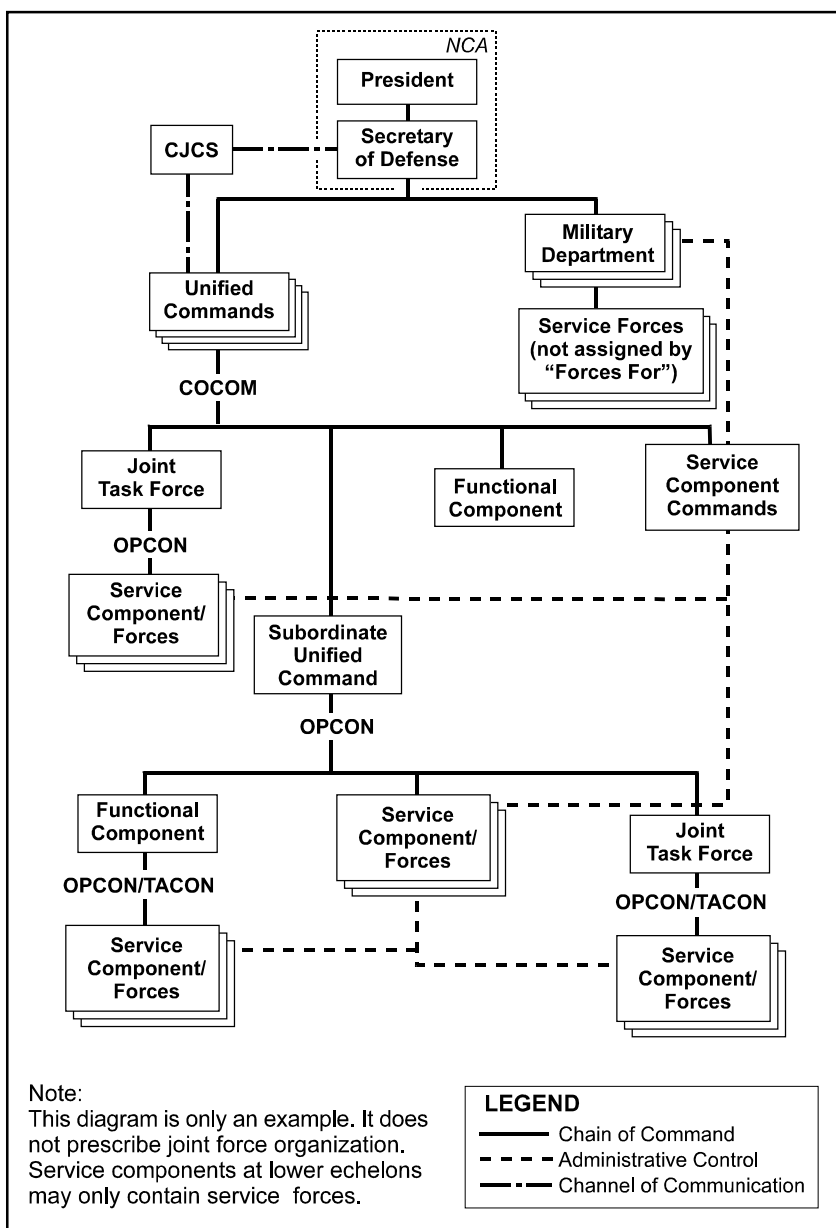

Figure 2-2. The Chain of Command and Control

Command Relationships

2-30. At theater level, when Army forces operate outside the US, they are assigned under a JFC (see JP 0-2; JP 3-0; FM 3-100.7). A JFC is a combatant commander, subunified commander, or joint task force (JTF) commander authorized to exercise COCOM or operational control (OPCON) over a joint force. Combatant commanders provide strategic direction and operational focus to forces by developing strategy, planning theater campaigns, organizing the theater, and establishing command relationships. JFCs plan, conduct, and support campaigns in the theater of war, subordinate theater campaigns, major operations, and battles. The four joint command relationships are COCOM, OPCON, tactical control (TACON), and support (see Figure 2-3).

Inherent responsibilities are:	If relationship is:		
	COCOM	OPCON	TACON
Has command relationship with:	Gaining combatant commander; gaining service component commander	Gaining command	Gaining command
May be task organized by:	Gaining combatant commander; gaining service component commander	Gaining command	Parent unit
Receives logistic support from:	Gaining service component commander	Service component command; parent unit	Parent unit
Assigned position or AO by:	Gaining component commander	Gaining command	Gaining command
Provides liaison to:	As required by gaining component commander	As required by gaining command	As required by gaining command
Establishes and maintains communications with:	As required by gaining component commander	As required by gaining command	As required by gaining command & parent units
Has priorities established by:	Gaining component commander	Gaining command	Gaining command
Gaining unit can impose further command relationship/ authority of:	OPCON; TACON; direct support; mutual support; general support; close support	OPCON; TACON; direct support; mutual support; general support; close support	Direct support; mutual support; general support; close support

Figure 2-3. Joint Command Relationships and Inherent Responsibilities

2-31. **Combatant Command (Command Authority).** COCOM is a non-transferable command authority exercised only by combatant commanders unless the NCA direct otherwise. Combatant commanders exercise it over assigned forces. COCOM provides full authority to organize and employ commands and forces to accomplish missions. Combatant commanders exercise COCOM through subordinate commands, to include subunified

commands, service component commands, functional component commands, and JTFs.

2-32. **Operational Control.** OPCON is inherent in COCOM. It is the authority to perform those functions of command that involve organizing and employing commands and forces, assigning tasks, designating objectives, and giving authoritative direction necessary to accomplish the mission. OPCON may be exercised at any echelon at or below the level of the combatant command. It can be delegated or transferred. Army commanders use it routinely to task organize forces. The secretary of defense must approve transferring OPCON of units between combatant commanders.

2-33. **Tactical Control.** TACON is authority normally limited to the detailed and specified local direction of movement and maneuver of forces to accomplish a task. It allows commanders below combatant command level to apply force and direct the tactical use of CSS assets but does not provide authority to change organizational structure or direct administrative or logistic support. The commander of the parent unit continues to exercise those responsibilities unless otherwise specified in the establishing directive. Combatant commanders use TACON to delegate limited authority to direct the tactical use of combat forces. TACON is often the command relationship established between forces of different nations in a multinational force. It may be appropriate when tactical-level Army units are placed under another service headquarters. Army commanders make one Army force TACON to another when they want to withhold authority to change the subordinate force organizational structure and leave responsibility for administrative support or CSS with the parent unit of the subordinate force.

2-34. **Administrative Control.** Unless the secretary of defense specifies otherwise, administrative control (ADCON) of Army forces remains within the Army chain of command, from lowest levels to the ASCC to the secretary of the Army. Administrative control is the direction or exercise of authority over subordinate or other organizations with respect to administration and support. It includes organization of service forces, control of resources and equipment, personnel management, unit logistics, individual and unit training, readiness, mobilization, demobilization, discipline, and other matters not included in operational missions of the subordinate or other organizations. ADCON is synonymous with Title 10 USC administration and support responsibilities. It is always subject to the command authority of the combatant commander.

Sample Army ADCON Responsibilities

- Personnel (including postal and personnel accounting)
- Finance (including commercial or vendor services)
- Medical and dental
- Legal
- Provost marshal
- Logistics: Classes I, II, III, IV, and IX, maintenance, distribution, contracting, and mortuary affairs
- General engineering (including public works)
- Chaplain and religious activities

2-35. **Support.** Joint doctrine establishes support as a command *authority*. Commanders establish it between subordinate commanders when one organization must aid, protect, or sustain another (see JP 0-2; JP 3-0). Under joint doctrine, there are four categories of support (see Figure 2-4). General and direct support describe the supporting command’s focus. Mutual and close support are forms of activity based on proximity and combat actions. Army doctrine establishes four support *relationships*: direct, reinforcing, general, and general support reinforcing (see Chapter 4).

CATEGORY	DEFINITION
General support	The action given to the supported force as a whole rather than to a particular subdivision thereof.
Mutual support	The action that units render each other against an enemy because of their assigned tasks, their position relative to each other and to the enemy, and their inherent capabilities.
Direct support	A mission requiring a force to support another specific force and authorizing it to answer directly the supported force’s request for assistance.
Close support	The action of the supporting force against targets or objectives that are sufficiently near the supported force as to require detailed integration or coordination of the supporting action with fire, movement, or other actions of the supported force.

Figure 2-4. Joint Support Categories

The Army Service Component Command

2-36. The ASCC commander is the senior Army commander in a combatant commander’s area of responsibility. The ASCC commander, using ADCON authority, is responsible for the Army Title 10 functions of preparing, maintaining, training, equipping, administering, and supporting Army forces attached to joint forces subordinate to the combatant command. Peacetime training of assigned Army forces is also under the ASCC. Combatant commanders may assign ASCCs responsibility for significant lead-service combat support (such as chemical decontamination) or common user logistic (CUL) functions. The ASCC also provides theater-strategic and operational-level support to combatant command campaign and major operation planning.

2-37. The ASCC commander normally designates an Army unit within each joint force subordinate to the combatant command as the ARFOR for that joint force. These ARFORs are responsible for accomplishing operational-level Army tasks within the joint force to which they are assigned. ASCC commanders establish C2 relationships for ARFORs and tailor the forces assigned to them to best meet combatant commander guidance. The ASCC commander may delegate authority to coordinate and execute Army operational-level Title 10 and lead-service CUL support responsibilities to a subordinate Army support unit, normally a theater support command (TSC). Other ASCC tasks described in JP 0-2 include—

- Recommending to the JFC or subunified commander the proper employment of Army component forces.
- Accomplishing operational missions as assigned.
- Selecting and nominating Army units for assignment to subordinate theater forces.
- Informing the combatant commander of Army CSS effects on operational capabilities.
- Providing data to supporting operation plans as requested.
- Ensuring signal interoperability.

The ARFOR

2-38. An **ARFOR** consists of the senior Army headquarters and all Army forces assigned or attached to a combatant command, subordinate joint force command, joint functional command, or multinational command. Providing Army forces within a joint operational area (JOA) is the responsibility of the ASCC of the combatant command. The term *ARFOR* is commonly used to describe both the headquarters of the Army forces provided to the joint force and the Army forces themselves. An ARFOR commander may not have OPCON of all of Army forces provided to the JFC; however, the ARFOR commander remains responsible for their administrative control (ADCON). See FM 3-100.7 for ARFOR organizational structures.

2-39. An ARFOR is designated whenever Army forces are involved in an operation. Even if separate Army forces are conducting independent operations within a JOA, there is only one ARFOR headquarters in that JOA. ASCCs, numbered army, and corps headquarters (with augmentation) are capable of serving as ARFOR headquarters. In certain smaller-scale contingencies, a division headquarters may be designated as ARFOR headquarters; however, a division headquarters requires extensive augmentation for this mission.

2-40. The ARFOR commander may also serve as JFLCC. A dual-hatted ARFOR commander normally gives some Army-specific tasks to a deputy commander. However, if an ARFOR commander becomes JTF commander, the next senior Army headquarters assumes ARFOR responsibilities. Combatant commanders may receive another Army headquarters for this.

2-41. An ARFOR headquarters may have a TSC attached to perform operational-level logistic and personnel support tasks. These include Title 10 lead service CUL support responsibilities and interagency support requirements.

MULTINATIONAL OPERATIONS

2-42. Although the US sometimes acts unilaterally, it pursues its national interests through alliances and coalitions when possible. In Operations Desert Shield and Desert Storm, more than 800,000 military personnel from 36 nations combined their will, forces, and resources to oppose the Iraqi armed forces. Forming the coalition increased the size of the overall force, shared the cost of waging the war, and enhanced the legitimacy of the strategic aims. Operations Desert Shield and Desert Storm demonstrated the advantage of successful multinational warfare over unilateral efforts.

2-43. Multinational operations are conducted within the structure of an alliance or a coalition (see JP 3-16; FM 3-16). Military alliances, such as the North Atlantic Treaty Organization (NATO), may afford participating nations time to establish formal, standard agreements for broad, long-term objectives. Alliance members strive to field compatible military systems, establish common procedures, and develop contingency plans to meet potential threats in a fully integrated manner.

An *alliance* is the result of formal agreements (i.e., treaties) between two or more nations for broad, long-term objectives which further the common interests of the members.

A *coalition* is an ad hoc arrangement between two or more nations for common action.

2-44. Nations usually form coalitions for focused, short-term purposes. Often, coalition operations are conducted under the authority of a UN resolution. In successful coalitions, all parties agree to the commitment of forces, even if the resources each invests are different. While each nation has its own agenda, each brings value to the coalition, even if solely by contributing to the legitimacy of the enterprise.

2-45. An Army force commander designated as a multinational force commander faces many complex demands. These may include dealing with cultural issues, interoperability challenges, and an immature theater C2 organization. Commanders may also be required to address different national procedures, the sharing of intelligence, and theater support functions. Since coalition operations are not structured around standing agreements, a preliminary understanding of the requirements for operating with a specific

The written basis for allied unity of command is found in directives issued by the Combined Chiefs of Staff. The true basis lies in the earnest cooperation of the senior officers assigned to an allied theater. Since cooperation, in turn, implies such things as selflessness, devotion to a common cause, generosity in attitude, and mutual confidence, it is easy to see that actual unity in an allied command depends directly upon the individuals in the field.... This problem involves the human equation and must be met day by day. Patience, tolerance, frankness, absolute honesty in all dealings, particularly with all persons of the opposite nationality, and firmness, are absolutely essential.

General Dwight D. Eisenhower
 "Memorandum for an Allied Command.
 For Admiral Louis Mountbatten," 1943

foreign military may occur through peacetime military engagement. These developmental activities include, but are not limited to, ongoing personal contacts, pre-positioning of equipment, exercises, exchange programs, and humanitarian assistance. Every multinational operation is different. Commanders analyze the mission's peculiar requirements so they can exploit the advantages and compensate for the limitations of a multinational force.

2-46. The ASCC function of providing theater-level support is demanding in a multinational environment. Integrating the support functions of several national forces, which may be spread over considerable distances and across international boundaries, is a challenging task. However, multinational

partners provide additional resources to address the CSS challenges inherent in a force projection strategy. Deploying and employing combat power from a force projection base that is friendly, secure, and close to the AO—especially when that base offers a mature infrastructure—is preferable to making a forcible entry from a distant base.

2-47. The Army TSC normally provides multinational CSS and, with proper augmentation, other specific CSS functions. Although each nation is responsible for sustaining the forces it deploys, multinational CSS may achieve significant economy of force. Multinational CSS may be provided by lead nation, role specialist nation, or acquisition and cross-service agreements. However, an international agreement is required to provide support under the lead nation and role specialist nation methods. Ideally, the TSC provides common multinational CSS, and with proper augmentation, other CSS functions, as the ASCC determines. For theater-level support operations to function properly, combatant commanders must clearly articulate their CSS priorities. The formation of multinational CSS staff sections facilitates CSS coordination, reduces competition among multinational partners for common support, and lessens the burden on each (see JP 4-08).

Command and Control of Multinational Operations

2-48. Unity of command is unlikely in multinational operations. The level of command authority vested in a multinational force commander is established by agreement among the multinational partners. The president of the United States retains command authority over US forces. Most nations have similar restrictions. However, in certain circumstances, it may be prudent or advantageous to place Army forces under OPCON of a foreign commander.

2-49. To compensate for limited unity of command, commanders concentrate on achieving unity of effort. Consensus building, rather than direct command authority, is often the key element of successful multinational operations. Political and military policies of multinational partners can limit options for the organization of a multinational command. Long-standing alliances, such as NATO, have integrated command structures with designated nations providing force commanders. Staffs are integrated, and senior representatives from member nations often lead subordinate allied commands. Coalition command is more challenging because it involves combining forces with no standing C2 arrangements. Command relationships and C2 structures usually evolve as the coalition develops. Multinational C2 structures are usually one of three types: parallel command, lead nation command, or a combination of the two (see JP 3-16).

2-50. *Parallel command* exists when nations retain control of their deployed forces. It is the simplest to establish and may be the only arrangement that satisfies national sensitivities. However parallel command may weaken unity of effort and should be avoided if possible. Under parallel command, multinational forces are directed through existing national chains of command. Decisions are made through a coordinated effort of the political and senior military leadership of member nations and forces. The coalition leadership must develop a means for coordination among the participants to attain unity of effort. Because of the absence of a single commander, the use of a parallel command structure should be avoided if possible.

2-51. *Lead nation command* exists when the nation providing most of the forces and resources provides the multinational force commander. The lead nation can retain its own C2 structure and employ other national forces as subordinate formations. Commanders may combine other nations' staffs to better coordinate complementary capabilities. More commonly, limited integration of national staffs characterizes lead nation command. Lead nation and parallel command structures can exist simultaneously within a multinational force. This occurs when two or more nations serve as controlling elements for a mix of international forces. This was the command arrangement used by the Gulf War coalition. Western national forces were aligned under US leadership while Islamic forces were aligned under Saudi leadership.

2-52. The creation of an effective multinational staff requires experience, imagination, and cultural sensitivity. There is always a temptation to push multinational participants into secondary positions and do things according to US Army doctrine or habit. Long-term friction and potentially catastrophic misunderstandings usually cancel out the short-term gain in productivity these actions produce. Multinational commanders carefully tailor the staff to balance coalition and US officers, and take particular care to accord coalition officers the same access and influence as their countrymen.

2-53. During multinational operations, US forces establish liaison with assigned multinational forces early. Additional specialized liaison personnel in fields such as aviation, fire support, engineer, intelligence, public affairs, and civil affairs are also exchanged based on mission requirements. This integration fosters common understanding of missions and tactics, facilitates transfer of information, and enhances mutual trust and confidence.

2-54. An integrated command structure is probably most effective when partners are similar in culture, doctrine, training, and equipment, or if extensive cooperative experience exists. This approach requires each troop-contributing nation to receive, understand, plan, and implement missions the same way as the other troop-contributing nations. However, if the multinational force is composed of dissimilar nations, it may require a modified approach to achieve unity of effort. The JFC or multinational force commander may use his own staff for most planning functions, other national augmentees for their national expertise, and liaison officers to translate and relay instructions to their national forces. As capabilities develop, commanders may also consider using coordination centers to enhance stability and interaction within the multinational force (see JP 3-16; FM 3-16).

Conducting Multinational Operations

2-55. Commanders have to accommodate differences in operational and tactical capabilities among multinational forces. For example, not all armies have the staff structures or means to process, reproduce, or rapidly disseminate plans and orders. Decision authority delegated to staffs and subordinate commanders also varies among armies.

2-56. The commander's intent and concept of operations must be clearly and simply articulated to avoid confusion resulting from differences in doctrine and terminology. Integrating indirect fires, naval surface fires, close air support, interdiction, and information operations requires common maneuver

and fire support coordinating measures (FSCMs). All elements of the force must fully understand and strictly adhere to them. Detailed war-gaming, planning, and rehearsals help develop a common understanding of the operation plan and control measures. Operational and tactical plans address recognition signals, FSCMs, air support, communications, and liaison.

2-57. The collection, production, and dissemination of intelligence are major challenges in a multinational operation. There are many instances in which direct access to finished intelligence, raw data, source information, or intelligence systems is not allowed outside national channels. Multinational partners also normally operate separate intelligence systems to support their own policy and military forces. These national systems may vary widely in sophistication and focus. However, at a minimum, each nation contributes valuable human intelligence to the multinational effort. Commanders establish systems that maximize each nation's contribution and provide an effective intelligence picture to all units. Commanders arrange for the rapid dissemination of releasable intelligence and the use of available intelligence assets by all partners. A multinational intelligence staff at the headquarters facilitates integration of intelligence efforts.

2-58. Mission assignments of multinational units should reflect the capabilities and limitations of each national contingent. Some significant factors are relative mobility and size; intelligence collection assets; and long-range fire, SOF, and organic CSS capabilities. The ability to contribute to theater air and missile defense, training for operations in special environments, and preparing for defensive operations involving weapons of mass destruction is also important. Rapport with the local population, language considerations, and special skills should be considered as well. Multinational commanders may assign host nation forces home defense or police missions, such as rear area and base security. They may also entrust air defense, coastal defense, or a special operation to a single member of the multinational force based on the special capabilities of that force. The national pride of multinational partners is an important intangible factor that is considered when assigning missions.

INTERAGENCY COORDINATION

2-59. The instruments of national power complement and reinforce each other. By understanding the influence of other agencies, commanders can add diplomatic, informational, and economic depth to their military efforts. US military capabilities allow other agencies to interact with foreign powers from a position of strength and security. Just as integrating different unit capabilities results in the advantages of combined arms warfare, so synchronizing military power with other instruments of national power leads to dynamic strategic capabilities.

2-60. As campaigns and major operations develop, tasks and objectives that directly support military operations but are the responsibility of other agencies are identified. When commanders and planners identify these objectives, they submit them through the JFC to the Joint Staff for consideration and nomination to interagency working groups. Formal and task-specific interagency working groups coordinate policy and assign tasks among the various departments and agencies. Once a department or agency accepts a task, it

reports through the interagency working group to the Joint Staff. The Joint Staff links the JFC to this process.

2-61. The intricate links among the instruments of national power demand that commanders consider how all capabilities and agencies can contribute to achieving the desired end state. Interagency coordination forges a vital link between military operations and the activities of organizations such as nongovernmental organizations (NGOs); governmental agencies of the US, host nation, and partner nations; and regional, international, and UN organizations. Theater strategies routinely employ the capabilities of the entire US interagency network. The National Security Act of 1947 establishes an interagency process for national security-related issues. The National Security Council provides national-level oversight of this process (see JP 3-08).

2-62. Interagency cooperation poses challenges. Among the most difficult is lack of mutual familiarity among the various agencies. In joint operations, leaders from the different services generally share a common tradition and understanding of military matters. Interagency operations bring together leaders and staffs that often have no common experiences. The institutional values and experiences of the separate agencies and departments sometimes have few common points of reference. Some may even conflict. However, education and teamwork can create an understanding and awareness of the missions, strengths, weaknesses, and outlooks of the interagency members. This understanding can mitigate the friction inherent in interagency operations.

2-63. Along with international, host nation, and official US agencies, Army forces frequently operate with NGOs, such as the American Red Cross and World Emergency Relief. Working with NGOs often requires soldiers and leaders to be flexible and adaptive. Sometimes these organizations may not care to cooperate with military forces. However, US armed forces cooperate as much as their mission allows. Effective cooperation and coordination with NGOs reinforces the legitimacy of the armed forces involved in a unified action. Often NGOs—if they are well disposed toward the military—can provide useful information and insights concerning the local populace.

2-64. NGO capabilities can dramatically reduce the military resources required for civil-military operations. NGOs have local contacts and experiences. They conduct such diverse activities as education, technical projects, relief activities, refugee assistance, public policy, and developmental programs. NGOs are frequently on the scene of a crisis before US forces. They routinely operate in high-risk areas and usually remain long after military forces have departed. They are a significant factor and must be integrated into planning, preparing, executing, and assessing military operations. Commanders consider the activities of NGOs as well as mutual security and resource or support requirements when conducting unified action.

CONSIDERATIONS FOR UNIFIED ACTION

2-65. Joint doctrine addresses employment of Army forces in unified action. Each operation is different: factors vary with the situation and perspectives of the participants. Unified action has military, political, and cultural considerations (see Figure 2-5, page 2-20). These considerations are not all-inclusive

but highlight factors important to effectively employing Army forces in unified action.

MILITARY	POLITICAL	CULTURAL
<ul style="list-style-type: none"> • Targeting • Fire support coordination • Air and missile defense • Teamwork and trust • Doctrine, organization, and training • Equipment 	<ul style="list-style-type: none"> • Goals and objectives • National control of forces • Consensus building 	<ul style="list-style-type: none"> • Culture and language • Communication • Media relations • Law enforcement

Figure 2-5. Considerations for Unified Action

MILITARY CONSIDERATIONS

2-66. Unified action requires commanders to consider the same military factors they consider when conducting joint operations (see FM 3-16; FM 3-16). However, participation of multinational and interagency partners adds additional layers of complexity. The following areas require additional attention from commanders and staffs of units conducting unified action.

Targeting

2-67. The JFC defines how the land component participates in the joint targeting process. JFCs may delegate targeting oversight functions to a subordinate commander or may establish a joint or multinational targeting board. The targeting board may serve as either an integrating center or review mechanism. It prepares targeting guidance, refines joint target lists, and reviews target information from a campaign perspective. It is not normally involved in selecting specific targets and aim points or in developing attack packages (see JP 3-60; FM 3-60).

Fire Support Coordination

2-68. JFCs and multinational force commanders normally establish AOs for their subordinates. Within their AOs, land and naval force commanders are normally supported commanders and synchronize maneuver, fires, and interdiction. These commanders designate target priorities and the effects and timing of fires. However, all missions must contribute to accomplishing joint force objectives.

Interdiction is an action to divert, disrupt, delay, or destroy the enemy’s surface military potential before it can be used effectively against friendly forces.

2-69. Synchronizing operations in land or naval AOs with wider joint operations is particularly important. To facilitate synchronization, JFCs establish priorities for execution of operations throughout the theater or JOA, including within the land and naval force commanders’ AOs. Commanders assigned theater-wide functions by the JFC coordinate with the land and naval force commanders when their operations, to include attacking targets, occur within a land or naval AO (see JP 3-09).

2-70. Army force commanders recognize the enormous potential of synchronizing maneuver with interdiction. They visualize the links between operations within the land AO and joint operations occurring outside it. They identify interdiction targets outside the land AO that can help create conditions for their decisive operations. They advocate combinations of maneuver and interdiction inside and outside the land AO that impose dilemmas on the enemy. Army commanders understand the theater-wide flexibility and reach of unified air operations. When required, they support joint interdiction outside land AOs with Army assets.

2-71. Integrating joint fires requires the development and full understanding of and strict adherence to common maneuver control measures and FSCMs. To ensure timely and effective fires, JFCs develop control measures and FSCMs early and emphasize them continuously. Land and amphibious force commanders may establish a fire support coordination line (FSCL) within their AO to facilitate current and future operations, and to protect the force (see JP 3-09). The FSCL is an FSCM that is established and adjusted by land and amphibious force commanders within their boundaries in consultation with superior, subordinate, supporting, and affected commanders. FSCLs facilitate the expeditious attack of surface targets of opportunity beyond the coordinating measure. An FSCL applies to all fires of air-, land-, and sea-based weapons systems using any type of ammunition. Coordination of attacks beyond the FSCL is especially important to commanders of air, land, and special operations forces.

2-72. Forces attacking targets beyond an FSCL must inform all affected commanders in enough time to allow necessary action to avoid fratricide, both in the air and on the ground. In exceptional circumstances, the inability to conduct this coordination does not preclude attacking targets beyond the FSCL. However, failure to coordinate increases the risk of fratricide and may waste limited resources. Short of an FSCL, the appropriate land or amphibious force commander controls all air-to-ground and surface-to-surface attack operations. For example, air strikes short of the FSCL—both close air support and air interdiction—must be under positive or procedural control (for example, by forward air controllers or tactical air control parties) to ensure proper clearance of fires. This control is exercised through the operations staff or with designated procedures.

2-73. The FSCL is not a boundary. The establishing commander synchronizes operations on either side of the FSCL out to the limits of the land AO. The establishment of an FSCL does not create a “free-fire area” beyond the FSCL. When targets are attacked beyond an FSCL, the attacks must not produce adverse effects forward, on, or to the rear of the line. Attacks beyond the FSCL must be consistent with the establishing commander’s priorities, timing, and desired effects. They are deconflicted with the supported headquarters whenever possible.

Air and Missile Defense

2-74. The area air defense commander (AADC) establishes rules of engagement and assigns air defense missions for operational-level air and missile defense assets. Army force commanders communicate their requirements through the JFC to the JFACC and AADC when developing air and missile

defense plans. When the JFC apportions ARFOR assets, including operational-level assets, to the air component for counterair missions, they are generally placed in direct support to the air component. Normally, Army corps retain control of organic air defense units. The JFC may designate the joint or multinational air component commander as the AADC.

Teamwork and Trust

2-75. In unified action, commanders rely upon rapport, respect, knowledge of partners, team building, and patience. Commanders build teamwork and trust in a joint or multinational force in many ways. They and their staffs should establish a direct, personal relationship with their counterparts. Commanders must establish and maintain a climate of mutual respect. They should know their partners as well as they know their adversary. Team building is essential. It can be accomplished through training, exercises, and assigning missions that fit organizational capabilities. Building teamwork and trust takes time and requires the patience all participants. The result is enhanced mutual confidence and unity of effort.

Doctrine, Organization, and Training

2-76. National and service military doctrines vary. Some doctrines emphasize the offense, others the defense. US Army doctrine stresses rapid, agile operations based on exercising disciplined initiative within the commander's intent. When determining the units best suited for particular missions, commanders must be sensitive to doctrinal differences and their consequences. In dealing with joint and multinational forces, commanders must remember that doctrine and organization are closely linked. Removing part of a service's or nation's force structure may make it unbalanced and make it fight in a way not supported by its doctrine and training. Adjusting a component's force structure, if authorized, must be done with extreme caution. Commanders also need to understand the training level of participating forces. All armies do not have the same training resources. A battalion-sized unit from one country may have different capabilities than one from a different country. Commanders must understand that not all organizations are the same.

Equipment

2-77. Different equipment and technologies may result in a mixture of systems in a joint or multinational force. The modernization levels, maintenance standards, mobility, and degree of interoperability of different partners will probably vary. Commanders of a joint or multinational force may have to compensate for significant technological differences among its components. Incompatible communications, unfamiliar CSS needs, and differences in vehicle cross-country mobility can pose difficulties. Some multinational partners may use systems similar to enemy systems, making measures to preclude fratricide vital. However, one nation's capabilities may reduce another's vulnerabilities. Commanders position units and assign command and support relationships to exploit interoperability and complementary capabilities.

POLITICAL CONSIDERATIONS

2-78. Political considerations are prominent in unified action. Gaining and maintaining unity of effort in multinational and interagency environments requires constant attention. Commanders remain aware of the goals and objectives of the various participants. They recognize that control of national forces and nonmilitary partners by their political leaders may affect mission accomplishment. Commanders constantly work to sustain political consensus among the leaders, nations, and organizations involved in the operation.

Goals and Objectives

2-79. States act to serve their national interests. No two partners share the same reasons for conducting a military operation. National goals can be harmonized with a common strategy, but they are seldom identical. Motivations of multinational partners may differ, but multinational objectives should be attainable, clearly defined, and supported by each member state. Successful coalitions and alliances build upon a common purpose. Emphasizing commonalities can reduce friction and maintain cohesion.

National Control of Forces

2-80. Most forces and agencies have the capability for direct and near immediate communications from the operational area to their respective political leaders. This capability can facilitate coordination of political issues. It can also allow those leaders to issue guidance directly to their deployed national forces or veto operational decisions. Likewise, Army force commanders are linked to the appropriate US agencies and political leaders.

Consensus Building

2-81. Reaching a consensus on a goal is the most important prerequisite for successful unified action. Because consensus is frail, commanders continually nurture it. A common goal is important, so commanders expend a lot of time and effort clarifying and restating it. Commanders seek a clearly defined, decisive, and attainable end state and measures of effectiveness. Some partners may resist establishing these to the level of detail that US commanders prefer. The minimum requirement is a set of identifiable military conditions that commanders can use to direct military operations.

CULTURAL CONSIDERATIONS

2-82. Understanding and dealing with cultural considerations can make the difference between success and failure in unified action. National and organizational culture, language, communication, media relations, and law enforcement all play important roles in this environment.

Cultural and Language

2-83. Each partner in unified action has a unique cultural identity. Military forces, civilian agencies, NGOs, and international organizations approach war and MOOTW from different perspectives. National and organizational values, standards of social interaction, religious beliefs, and organizational discipline all affect the perspectives of multinational partners. Partners with similar cultures and a common language face fewer obstacles to

interoperability. Even seemingly minor differences, such as dietary restrictions or officer-enlisted relationships, can significantly affect military operations. Commanders may have to accommodate cultural sensitivities and overcome diverse or conflicting religious, social, or traditional requirements.

2-84. Overcoming language barriers is a significant challenge. Unified action is often multilingual. Even when partners share a common language, different terminology and jargon can hinder understanding. Whether spoken or written, all participants must understand all communications. Commanders recognize translation difficulties. Translating orders adds time to planning. Translation errors can cause mistakes or misunderstandings. Few translators have both the language and cultural expertise and the depth of doctrinal understanding necessary. Dedicated liaison and linguist teams can mitigate this problem but cannot eliminate it. Clear, concise orders and briefings are easier to translate than complicated ones. Simplicity helps achieve the mutual understanding necessary for success. Backbriefs to commanders ensure that multinational subordinates understand intent and tasks.

Communication

2-85. Differences in individual assumptions and organizational perspectives can cloud common understanding. Commanders involve representatives from each partner in defining issues in clear, unambiguous, agreed-upon terms. How something is said is particularly important in the interagency environment. To preclude misunderstandings, military planners anticipate confusion and take measures to clarify and establish common terms with clear and specific usage. To reduce duplication and increase coherence, commanders get from all participants a clear expression of their perceived role and mission as well as the resources they intend to contribute. Understanding each participant's agenda helps commanders synchronize the efforts of the each organization throughout the campaign. Common understanding also helps identify obstacles, such as conflicting multinational or interagency priorities.

Media Relations

2-86. Within security requirements, commanders facilitate national and international press activities. In multinational environments, media from partner states have their own standards and requirements. Commanders work with leaders of partner forces and their national press elements to develop an open, mutually beneficial environment. To avoid misunderstanding, senior multinational political and military representatives establish media ground rules that are as simple as possible. To facilitate foreign and US media relations, US forces follow the DOD Principles of Information whenever possible. Military plans anticipate the effect of media actions. The media shape public attitudes and can influence operations. Commanders recognize that gaining and maintaining public support requires clearly expressing the desired end state, objectives leading to it, and measures of effectiveness through the media. Different partners do not necessarily send the same messages; but commanders determine and coordinate methods to avoid contradictions.

Law Enforcement

2-87. Often US forces will not have the authority or capability to enforce civil laws in the operational area. Commanders seek clear law enforcement guidance from US and multinational political leadership during planning for unified action. The entire chain of command must understand status of forces agreements (SOFAs), or status of mission agreements (SOMAs), which apply to UN operations. Where civil law enforcement is present and functioning, commanders establish systems and procedures to use it. Where civil law enforcement systems and organizations are not available, commanders should deploy with appropriate US forces or use the capabilities of other partners.

Chapter 3

Strategic Responsiveness

Generally, he who occupies the field of battle first and awaits his enemy is at ease; he who comes later to the scene and rushes into the fight is weary.

Sun Tzu
The Art of War

3-1. Strategic responsiveness requires Army forces trained, organized, and equipped for global operations, and commanders and units proficient at force projection. Strategically responsive Army forces—including active component (AC) and reserve component (RC) forces based in the continental United States (CONUS) and overseas—generate and sustain maximum combat power at the time and place joint force commanders (JFCs) require.

CONTENTS	
Responsive Army Forces	3-0
Attributes of Strategically	
Responsive Army Forces	3-1
Considerations of Strategic	
Responsiveness	3-4
Force Projection Operations	3-12
Force Projection Characteristics	3-13
Joint Systems	3-15
Entry Operations	3-16
Security of Force Projection	
Operations	3-17
Intermediate Staging Bases	3-17

RESPONSIVE ARMY FORCES

3-2. Strategic responsiveness imposes a unique set of dynamics on the US Army. The Army depends on assets apportioned by the National Command Authorities and allocated by the US Transportation Command to combatant commanders and JFCs. The combatant commander establishes the priority for movement of forces into the theater. That decision drives allocation of strategic lift and ultimately determines how rapidly Army forces deploy. Although US strategic lift assets exceed those of any other nation, the available lift is almost never enough to move large Army forces at one time. Consequently, commanders carefully tailor both the elements of the force and the sequence in which they deploy them to match theater conditions.

Force tailoring is the process of determining the right mix and sequence of units for a mission.

3-3. The range of possible scenarios complicates training. Army forces cannot train for every possible mission; they usually train for war and prepare for specific missions as time and circumstances permit. The volatile nature of crises requires Army forces to simultaneously train, deploy, and execute.

Commanders conduct (plan, prepare, execute, and continuously assess) operations with initial-entry forces, while assembling and preparing follow-on forces. To seize the initiative during deployment and the early phases of an operation, commanders accept calculated risks, even when the enemy situation is not well developed. Balancing these dynamics is an art mastered through study, experience, and judgment.

3-4. Modernization will transform Army force projection capabilities. Contingency operations in the 1990s normally followed a sequence of alert, deployment, extended build-up, and shaping operations—followed by a period of decisive operations to terminate the conflict. Operations Desert Shield and Desert Storm exemplify this sequence. The interim Army force now being developed will consist of lethal and highly mobile initial-entry Army units that will deploy, contain large-scale aggression, and shape the situation in the land area of operations (AO) for much earlier decisive operations. In smaller-scale contingencies, combinations of modernized brigades and forcible entry units will provide JFCs with decisive initial-entry capabilities. When fielded, the objective Army force will achieve the strategic responsiveness necessary to conduct nearly simultaneous deployment, shaping, and decisive operations in a manner similar to that of Operation Just Cause, but against more robust opponents. The Army is modernizing combat service support (CSS) capabilities as well. Improvements are underway to reduce the CSS footprint and replenishment demands by leveraging CSS reach capabilities. At the same time, the Army is investing in new systems that minimize support requirements and radically improve the manner in which it transports and sustains soldiers, equipment, and materiel.

3-5. The payoff for mastering the art of strategic responsiveness is operational success. Fast deploying and rapidly expansible Army forces provide JFCs with the means to introduce an operationally significant land force into a crisis theater on short notice. Responsiveness provides JFCs a preemptive capability to deter adversaries, shape the situation, and fight and win if deterrence fails. Responsive Army forces provide immediate options for seizing or regaining the operational initiative. They complement and reinforce the other services with combat, combat support (CS), and CSS units that can be swiftly tailored, deployed, and employed to produce decisive effects.

ATTRIBUTES OF STRATEGICALLY RESPONSIVE ARMY FORCES

3-6. Seven attributes of strategically responsive forces drive programmatic and operational requirements. The Army is redesigning the force around them. Structure, equipment, and training—including deployment doctrine; power projection platforms; command and control (C2) systems; intelligence, surveillance, and reconnaissance systems; and joint transportation systems—establish the foundation for responsive forces.

Attributes of Strategically Responsive Forces

- Responsive
- Deployable
- Agile
- Versatile
- Lethal
- Survivable
- Sustainable

3-7. Each operation is different: there may not be a single ideal deployment sequence that optimizes all seven force attributes. However, from an operational perspective, commanders train their forces to emphasize all seven. Upon alert, commanders tailor and sequence the force to balance the attributes while meeting JFC requirements.

Responsive

3-8. Responsiveness is an attitude that spans operational planning, preparation, execution, and assessment. It establishes the conditions for successful operational and tactical maneuver at the outset of operations. Responsiveness is more than the ability to quickly deploy: it requires that the right Army forces—those the JFC needs to deter an adversary or take decisive action if deterrence fails—deploy to the right place at the right time. Forward deployed units, forward positioned capabilities, peacetime military engagement, and force projection from anywhere the needed capabilities reside all contribute to Army force responsiveness.

3-9. Responsiveness also emphasizes training, planning, and preparation for deployment. Commanders recognize that crises rarely allow sufficient time to correct training deficiencies between alert and deployment. They ensure that their units are prepared to accomplish their mission essential task list (METL) tasks before alert and to concentrate on mission-specific training in the time available afterwards. In addition, commanders emphasize individual preparation and equipment readiness. Finally, commanders review and practice alert and deployment plans and procedures, updating them based on lessons learned. They pay particular attention to the automated data used for deployment planning, ensuring that it accurately reflects unit organization and equipment.

3-10. Responsiveness requires balancing the demands of readiness with the realities of day-to-day training. Commanders develop and implement mission readiness postures appropriate for their unit. They evaluate the mission of the unit and carefully design mission readiness cycles to match the required readiness posture.

Deployable

3-11. Army forces combine training, facilities, soldiers, and equipment to deploy with speed and force. Commanders view deployment as more than getting people and equipment on ships and airplanes; they visualize the entire process, beginning with the fully operational unit deployed in theater, and reverse plan to the unit's predeployment location. They include deployment details in standing operating procedures (SOPs). Plans focus not only on the sequence of actions but also on force packages for different scenarios. Deployment rehearsals occur as often as time permits. Commanders and subordinate leaders conduct reconnaissance of deployment facilities and routes, and review contingencies. They stress junior leader initiative and responsibility as essential during deployment. The intelligence community supports deployability through readiness and the ability to quickly collect information about the enemy or adversary, process it into intelligence, and disseminate that intelligence as relevant information.

Agile

3-12. Agility is a tenet of Army operations as well as a responsive force attribute. A responsive, agile force package is one that is sustainable and mobile enough to accomplish the mission. Limitations on available lift compel commanders to balance competing mission requirements, in some cases developing innovative solutions. It also requires commanders to anticipate a full range of tasks and include capabilities to accomplish them. Finally, agile forces are mentally and physically able to transition within or between types of operations without losing momentum. Commanders develop this state of mind through tough, realistic training. Mentally agile commanders, staffs, and soldiers adapt force packages, strategies, and tactics to mission requirements in dynamic environments.

Responsive and Agile—Operation Uphold Democracy

The 1994 Operation Uphold Democracy in Haiti demanded Army forces to demonstrate an extraordinary degree of agility and responsiveness. Months before operations began, the 82d Airborne Division prepared plans for a short-notice forcible entry into Haiti. Completed plans detailing the use of overwhelming lethal force to seize key targets awaited only a decision to execute. Then, on 19 September, with the 82d already in flight to execute the plan, word suddenly arrived that a last-minute diplomatic effort had succeeded in securing the permissive entry of US forces.

With the sudden change in conditions, the Haiti mission passed from the invasion force, which returned home, to the 10th Mountain Division, which began arriving in Port-au-Prince in a matter of hours. In addition, special operations forces (SOF) blanketed the country within a week. Active engagement of the populace quickly established a measure of trust that furthered both SOF security and the effectiveness of the mission. Meanwhile, although initial living and working conditions in Port-au-Prince and elsewhere were predictably austere, CSS forces responded rapidly as equipment and other resources poured into Haiti.

American agility notwithstanding, conditions on the ground in Haiti remained unclear. Joint Task Force (JTF) 180 commander, LTG H. Hugh Shelton, found himself in the unanticipated position of negotiating the terms of a transition of power and working with representatives of the very regime he had earlier expected to remove. In turn, JTF 190 commander, MG David Meade, worked to secure the cooperation of police and civil officials in the capital. Army forces responded flexibly to a highly fluid and ambiguous situation.

Versatile

3-13. Like agility, versatility is a tenet of Army operations. Army forces conduct prompt and sustained full spectrum operations with forces tailored to accomplish the mission. Versatility requires Army force packages able to reorganize and adapt to changing missions. Commanders carefully tailor and sequence forces into theater, making sure forces have the necessary C2, combat, CS, and CSS assets. Whenever possible, commanders deploy multifunctional teams. However, they understand that teams gathered from different

organizations do not execute efficiently unless trained to work together. Thus, training emphasizes teamwork and adaptability. Commanders stress versatile C2 and practice reconfiguring headquarters to control multiple missions.

Lethal

3-14. Army forces combine the elements of combat power to defeat the enemy. When deployed, every unit—regardless of type—generates combat power and contributes to the fight. From the operational and tactical perspectives, commanders ensure deployed Army forces have enough combat power to overwhelm any likely enemy. The art of strategic responsiveness requires that commanders balance the ability to mass the effects of lethal combat systems against the requirement to deploy, support, and sustain the units that employ those systems. Commanders assemble force packages that maximize the lethality of initial-entry forces consistent with both the mission and the requirement to project, employ, and sustain the force. They tailor and sequence follow-on forces to increase both the lethality and operational reach of the entire force.

Elements of Combat Power

- Maneuver
- Firepower
- Leadership
- Protection
- Information

Survivable

3-15. Survivability combines technology and methods that afford the maximum protection to Army forces. Lethality enhances survivability: lethal forces destroy enemies before they strike and can retaliate if necessary.

3-16. Deploying commanders integrate sufficient force protection assets to ensure mission accomplishment. Engineer, air defense, and chemical units increase the survivability of deployed Army forces. As with the other attributes, lift constraints and time available complicate the situation. Survivability requires an astute assessment of operational risk. In many operations, rapid offensive action may provide better force protection than massive defenses around lodgment areas.

Sustainable

3-17. Generating and sustaining combat power is fundamental to strategic responsiveness. Commanders reconcile competing requirements: On one hand, Army forces must accomplish JFC-assigned missions. On the other, they need adequate sustainment for operations extended in time and depth. Commanders tailor force packages to provide sufficient CSS while exercising every solution to reduce the CSS footprint. In some cases, commanders augment CSS capability with host nation and contracted support.

CONSIDERATIONS OF STRATEGIC RESPONSIVENESS

3-18. Applying the art of strategic responsiveness requires mastery of the considerations of strategic responsiveness. These considerations complement and supplement the attributes of strategically responsive Army forces.

Anticipation

3-19. Commanders anticipate future operations. They train their units for alert and deployment and prepare them for any likely change of mission. If units are assigned a peacetime region or mission focus, mental and physical preparation and planning can occur long before alert and deployment. The intelligence system gives commanders the ability to anticipate future operations by providing strategic through tactical indications and warning and maintaining intelligence readiness. Appropriate actions include initiating or adjusting mission- and region-specific training, organizing C2 for entry operations, conducting staff training, ordering and posting maps, studying available infrastructure, coordinating with appropriate agencies, and training deployment procedures. These actions allow units to deploy without additional training that may slow deployment.

Considerations of Strategic Responsiveness

- Anticipation
- Command and control
- Lethality of the deploying force
- Force tailoring
- Combat service support
- Training

3-20. Decisions about size, composition, structure, and deployment sequence create the conditions for success in theater. Ideally, commanders identify potential decisions before the actual event. Prior planning develops options to meet possible situations. Exercises refine concepts and procedures. However, the nature of an operation can change significantly before execution. Commanders ensure that their plans and decisions do not foreclose options the deployed force may need later. Operational and tactical plans as well as the deployment process and flow need to be flexible enough to accommodate changes made after the alert. Other important decisions include—

- Command and support relationships.
- Prioritization of unit and equipment movement (see JP 3-35).
- Transportation modes for early deploying units.
- Reception, staging, onward movement, and integration (RSO&I) responsibilities and procedures (see JP 4-01.8; FM 4-01.8).
- Plans for interacting with media and other civilian agencies and organizations.

Command and Control

3-21. Strategic and operational commanders decide strategic aims, force requirements, force allocation, which organizations to mobilize and deploy, and when to do so. Seldom are these decisions clear at the outset. Mobilization, deployment, and employment occur simultaneously against a backdrop of fog and friction, challenging commanders to make timely decisions that set the basis for future success. Effective C2, equipment, facilities, intelligence, and procedures give commanders the support they need to visualize the operation, describe their vision to subordinates, and direct actions to implement their decisions. In particular, modern information systems provide commanders with a common operational picture (COP) that allows them to see and track forces from home station through arrival in theater to combat

employment. The COP—which includes friendly, threat, and environmental elements—helps commanders make timely, accurate decisions about force sequence and direct resources and forces where needed by units in theater.

3-22. Modular C2 enhances the commander's ability to tailor the headquarters for split-based-operations throughout the operation. For example, deployment may physically separate units from their higher headquarters and sister elements. A modular C2 structure allows the leadership of a deploying unit to retain command of the unit and control RSO&I in the theater staging base before employment.

3-23. Commanders require home station, en route, and in-theater communications that are secure, reliable, and timely. Communications must be compatible with the mix of supporting forces and services in theater, including civilian agencies of the US government. Units establish communications with other organizations and services participating in the operation.

3-24. Army and joint systems track forces and forecast their arrival in theater. Force tracking reports combat status to JFCs. It provides immediate and constant information about present and forecasted unit combat capability during force

Force tracking is the identification of units and their specific modes of transport during movement to an objective area.

projection operations. Support units and staffs report unit movements, while operations staffs track them and report the build-up of operational capability. Force tracking requires a definition of readiness against which commanders can evaluate unit status and visibility of all assets required. JFCs normally define combat readiness based upon the operation or situation.

3-25. Commanders visualize force projection as one seamless operation. Deployment speed sets the initial rate of military activity in theater. Commanders understand how speed, sequence, and mix of deploying forces affect their employment options. In turn, they see how their employment concept establishes deployment requirements. Commanders prioritize the force mix on the time-phased force and deployment data (TPFDD) to get forces in theater where and when required. They recognize that decisions made early in the force projection process affect employment throughout the JFC's campaign. Singular focus on the land component plan may result in the incorrect force sequencing. Active and continuous command involvement during all stages of force projection, coupled with detailed reverse planning, combine to ensure the right forces with the right support are available and ready to conduct decisive operations when needed.

Lethality of the Deploying Force

3-26. An important strategic factor is the early introduction of credible, lethal forces into the theater. This action may quickly convince a potential enemy that further aggression is too costly. Initial-entry forces need to be interoperable and flexible enough to handle unforeseen circumstances. Initial-entry forces require enough combat power to establish and protect lodgments and begin simultaneous shaping operations immediately upon arrival. Doing this requires tailored and very precise relevant information. The ability to fight at

the outset is crucial to the successful execution of the theater campaign plan. A tailored force with the capability to dominate situations early enables the JFC to seize the initiative.

Force Tailoring

3-27. **Force tailoring is the process of determining the right mix and sequence of units for a mission.** Army commanders tailor forces to meet specific requirements determined by the JFC and passed through the Army service component command (ASCC). Units identified for rapid deployment are tailored to mission requirements. They standardize, as much as possible, an initial-entry force package based on anticipated deployment requirements. These force packages consist of configured and basic loads that are included in the TPFDD. Units develop tailored load plans to match anticipated contingencies. These force packages include enough combat power to sustain and protect themselves for the short term, wherever they might go. Follow-on forces are tailored to meet specific concerns of the long-term mission.

3-28. Generally, commanders tailor subordinate forces. For example, a corps commander may tailor a deploying division by augmenting its organic assets with an additional infantry brigade and two corps artillery brigades. During tailoring, commanders balance the combat power necessary to accomplish the mission with the speed of deployment to ensure the deploying force is operational and sustainable upon arrival.

3-29. During mission analysis and force tailoring, commanders pay special attention to strategic lift, pre-positioned assets, host nation support, and theater support contracts. For an unopposed entry operation, for example, commanders schedule CSS, engineer, military police, civil affairs, and combat health support to deploy early, particularly if faced with limited host nation support and infrastructure. Faced with a forcible entry operation, commanders tailor their flow and mix differently, placing the right mix of combat units in the early deploying echelons. Commanders may find they need to substitute one type of unit for another or add units that have never trained together. This places a premium on early and continuous teamwork. Such teamwork, emphasized by visits and other contacts, builds the cohesion in the new team that is essential for mission success. Tailoring focuses on the vertical integration of the force; it ensures capabilities are matched in the proper combinations and sequence at each echelon. Tailoring the force includes force allocation, force augmentation, and force refinement.

3-30. **Force Allocation.** Commanders tailor a force to ensure that its size and capabilities—especially C2 capabilities—are sufficient to accomplish the mission. This process begins with the combatant commander allocating a basic force. Normally, the basic force is a combat unit—a division, an armored cavalry regiment, a Special Forces group, or a combined arms maneuver brigade. In stability operations or support operations, however, the basic force may be a CS or CSS unit, such as a military police, medical, civil affairs, or water purification unit.

3-31. **Force Augmentation.** Force augmentation rounds out the basic force with specialized capabilities. Army force structure is designed so that at each echelon has a set of capabilities that augment it from the next higher echelon.

Once the combatant commander allocates the basic force, the major Army command, in conjunction with the ASCC, augments it with the necessary supporting units. Figure 3-1 illustrates some representative echelons above division augmentations for a deploying division. Based on the mix of operations, these capabilities augment the organic capabilities of the basic force. They are not normally assigned to the division, although they may be placed under its operational control or in direct or general support to it.

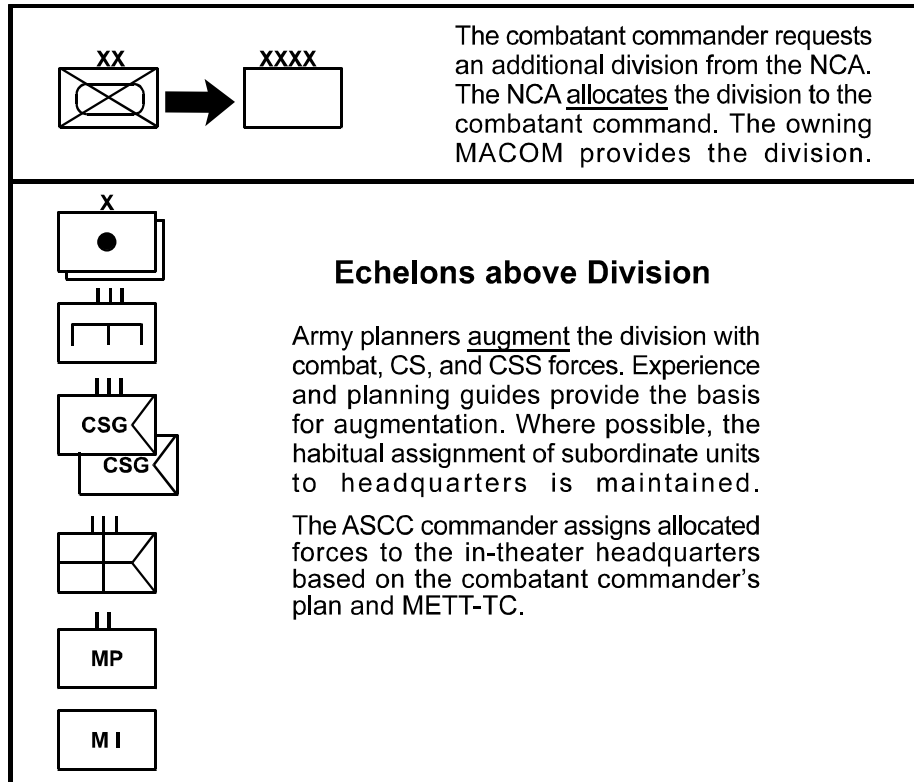

Figure 3-1. Force Allocation and Augmentation

3-32. **Force Refinement.** The basic force and its augmentation forces are refined to account for the multiple constraints of the projected operation. Force refinement is a repetitive, continuous process that involves all Army components and members of joint and interagency organizations. It includes JFCs and representatives from the Department of State, Joint Staff, Army Staff, ASCC, ARFOR headquarters, and other involved government agencies. Force refinement involves METT-TC adjustments, force sequencing, and staff tailoring, and task organizing.

- **METT-TC Adjustments.** Commanders analyze the basic force and its general augmentation using the factors of METT-TC—mission, enemy, terrain and weather, troops and support available, time available, civil considerations—to identify any changes necessary to account for the realities of the planned operation. Force allocation seldom produces an exact fit. Commanders refine the tailored force based on factors such as those in Figure 3-2. They apply the factors of METT-TC to the assigned unit organizations to determine necessary adjustments.

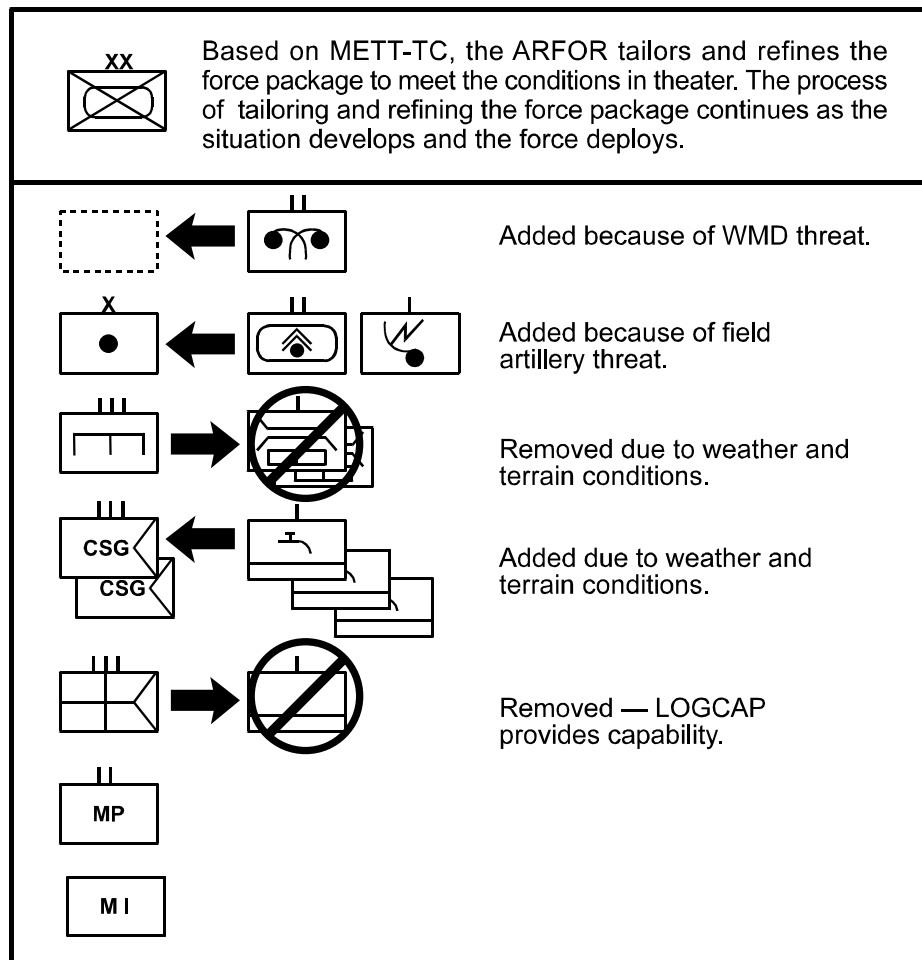

Figure 3-2. Allocation: Force Refinement

- Force Sequencing.** Commanders next compare the in-theater situation—in terms of the factors of METT-TC—against available lift to determine the appropriate deployment sequence. Balancing rapid response with the mix of combat power and resources that will accomplish the mission while protecting the initial-entry force is critical. Commanders seek a balance that provides protection, efficient deployment, and a range of options for responding to possible conditions. Lift availability is always a constraint, so difficult trade-off decisions are routine. For example, commanders often balance early deployment of combat forces against the need to deploy tailored CSS capability to generate and sustain combat power. Commanders and staffs keep in mind not only the priority for each capability's arrival but also its relationship to other capabilities. These relationships are key; changing the deployment sequence reschedules associated capabilities.
- Staff Tailoring.** Commanders tailor units and staffs, both in size and organization, to meet mission conditions. The standard peacetime staff may undergo significant changes in both size and organization to meet conditions. For example, the 1st Armored Division staff and headquarters underwent a dramatic transformation upon its commitment to

Bosnia as the Task Force Eagle headquarters (see Figure 3-3). To gain the personnel necessary to round out the staff, a headquarters identifies requirements to its higher headquarters. This begins a series of requests that are either filled by the next higher headquarters or passed up the chain of command.

- **Task Organizing.** Force tailoring is not synonymous with task organizing. While tailoring is a method to match force capabilities necessary to accomplish a mission, task organizing is the establishment of an organization with certain command relationships to accomplish the tasks at hand.

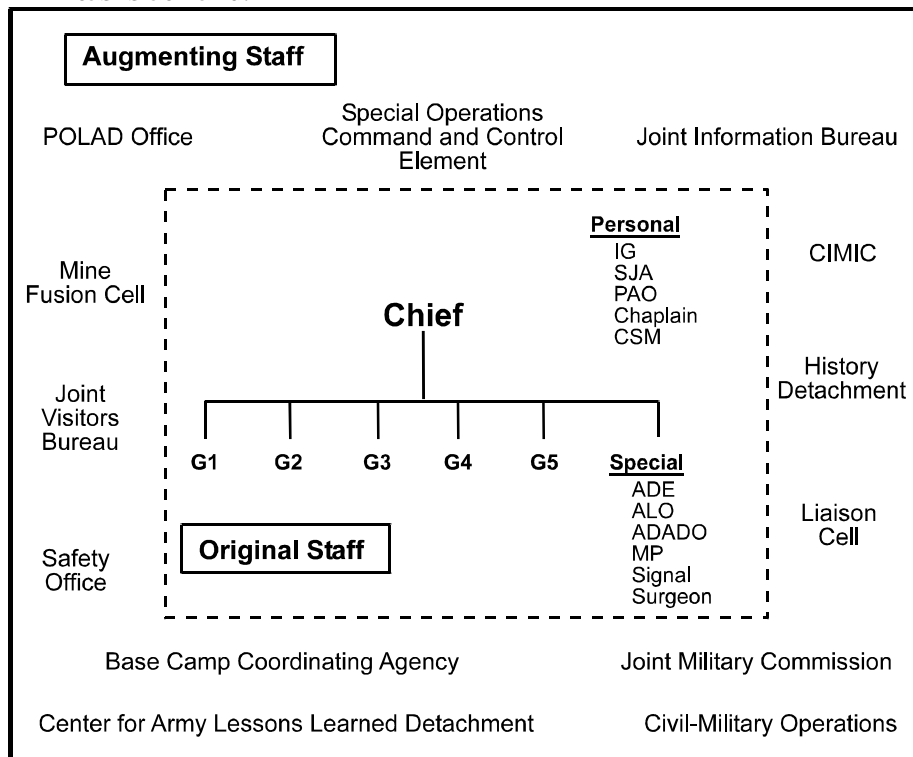

Figure 3-3. Staff Tailoring: Task Force Eagle

Combat Service Support

3-33. Generation of decisive combat power requires carefully balancing CSS assets with combat and CS assets. Achieving the right balance is an art; commanders attempt to maximize combat power while deploying only essential CSS capabilities. Too little CSS ties Army forces to their lodgment, unable to create and exploit oppor-

Factors Affecting CSS Operations

- Enemy threat
- Size of friendly forces
- Maturity of the theater
- Theater evacuation policy
- Supported force's CSS needs
- CSS infrastructure
- Availability of in-theater supplies
- Host nation support
- Theater support contracts.
- Acquisition and cross-servicing agreements

tunities. Too much CSS slows the arrival of combat power and leads to the same result. Likewise, accumulation of vast stockpiles of materiel and expendables may cede the initiative to the enemy.

3-34. To estimate the appropriate force mix, commanders thoroughly review and understand the effect of CSS operations on generating combat power. Force tracking, asset visibility, intelligence preparation of the battlefield, and logistic preparation of the theater are essential to responsive CSS. Logistic preparation of the theater assesses the existing theater infrastructure, which greatly affects planning for both CSS and operations. The availability of ports, roads, and other assets affects the sequencing of units and tempo of entry operations (see JP 4-0; FM 4-0). Force projection may require intermediate staging bases (ISBs), in-theater lodgment areas (with associated intratheater movement capabilities), or joint logistics over-the-shore (JLOTS) operations (when port infrastructure is limited or nonexistent) (see JP 4-01.6). Contracted CSS to augment military capabilities or provide initial support must be preplanned and reflected in the TPFDD. Split-based and modular CSS operations may reduce the burden on the intratheater deployment flow and preclude maintaining unnecessary supplies in theater. Split-based CSS operations, enhanced with robust automation and communications networks, allows much of the CSS and distribution management structure to operate from an ISB or CONUS.

Training

3-35. Training is the linchpin of strategic responsiveness. Prior to alert, units train for wartime missions and conditions first. Unless directed otherwise, division and lower-level commanders develop battle focused METLs. When corps and higher-level commanders anticipate a stability mission or support mission, they may direct subordinate commanders to develop METLs to support employment in those missions. Leaders at every echelon conduct mission essential individual and collective training before and during deployment. Tactical commanders identify tasks that apply to all types of operations and ensure individual and collective proficiency in them. Commanders accept risk and defer training for some tasks until the unit alerts and prepares for deployment.

3-36. After alert, Army forces conduct mission-tailored training and rehearsals. If time permits, commanders conduct mission rehearsal exercises (MRXs) to reinforce their vision and intent. A good MRX exposes units to conditions approximating those in theater. Commanders ensure that rehearsals are realistic and take full account of chance, friction, and ruthless, thinking opponents. Good rehearsals allow room for initiative and improvisation. Even when time is very short and resources scarce, commanders conduct some type of rehearsal, such as map-based or computer-supported virtual MRXs, with subordinates.

3-37. Force projection operations vary in time, distance, and size but always include certain actions and functions. Most force projection operations include data preparation; planning; and rail, air and ship loading. These operations provide opportunities for multiechelon training. Training—to include rehearsals—begins at home station and continues throughout an operation, as the situation permits. Units also perform the coordination necessary to pass

lessons to follow-on forces. Training to maintain readiness for future operations continues after hostilities cease.

FORCE PROJECTION OPERATIONS

3-38. Force projection is the military component of power projection. It is a central element of the national military strategy. Projecting the force anywhere in the world involves AC and RC units, the mobilization base, DA civilians, and industry. Army organizations and installations, linked with joint forces and industry, form a strategic platform to maintain, project, and sustain Army forces, wherever they deploy.

3-39. Force projection encompasses a range of processes: mobilization, deployment, employment, sustainment, and redeployment (see Figure 3-4). These processes occur in a continuous, overlapping and repeating sequence throughout an operation. Force projection operations are inherently joint and require detailed planning and synchronization. Decisions made early in the process may determine the success of the campaign.

- **Mobilization** is the process by which the armed forces or part of them are brought to a state of readiness for war or other national emergency. It assembles and organizes resources to support national objectives. Mobilization includes activating all or part of the reserve components, and assembling and organizing personnel, supplies and materiel (see JP 4-05; FM 3-35).
- **Deployment** is the movement of forces and materiel from their point of origin to the AO. This process has four supporting components: pre-deployment activities, fort to port, port to port, and port to destination (RSO&I) activities (see JP 3-35; FM 3-35 series; FM 4-01.8).
- **Employment** is the conduct of operations to support a JFC (see JP 3-0 series; FM 3-100.7). Employment encompasses a wide array of operations including but not limited to—
 - Entry operations (opposed or unopposed).
 - Shaping operations (lethal and nonlethal).
 - Decisive operations (combat or support).
 - Postconflict operations (prepare for follow-on missions or redeployment).
- **Sustainment** involves providing and maintaining levels of personnel and materiel required to sustain the operation throughout its duration. It is essential to generating combat power. CSS support may be split-based between locations within and outside of CONUS (see FM 4-0).
- **Redeployment** is the process by which units and materiel reposture themselves in the same theater; transfer forces and materiel to support another JFC's operational requirements; or return personnel, equipment, and materiel to the home or demobilization station upon completion of the mission. Redeployment operations encompass four phases:
 - Recovery, reconstitution, and pre-redeployment activities.
 - Movement to and activities at the port of embarkation.
 - Movement to the port of debarkation (POD).
 - Movement to home station (see JP 3-35; FM 3-35).

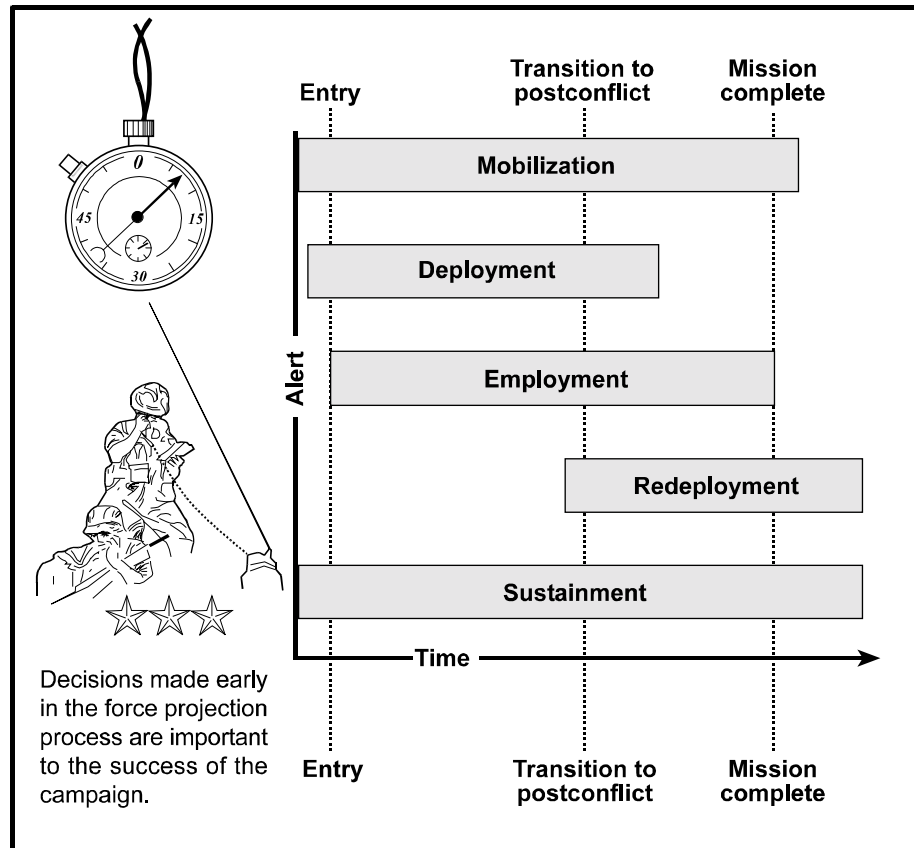

Figure 3-4. The Force Projection Process

FORCE PROJECTION CHARACTERISTICS

3-40. The objective of force projection is to conduct decisive operations so rapidly that the enemy is defeated before he can effectively confront US forces. That objective requires efficient and effective projection of Army forces. Taken as a whole, effective and efficient force projection exhibits four characteristics: precision, synchronization, speed, and relevant information. Commanders incorporate these characteristics into the conduct of force projection operations.

Precision

3-41. Efficient force projection makes maximum use of available time and lift. Eliminating wasted space and time requires precision in every activity and each piece of data related to it. The effect of precision is far-reaching; its payoff is speed of deployment and increased combat power in theater. Precise deployment equipment lists, for example, allow correct lift assets to be quickly assigned against requirements. Precision in loading increases departure speed and safety. Precision in meeting the JFC's time line supports the concept of employment. Up-to-date doctrine, realistic training, an adequate support structure, and timely enablers provide the framework for precision.

Synchronization

3-42. Commanders synchronize deployment activities. Resources—lift assets, enablers, time, and information—are scarce. Effective synchronization produces maximum use of every resource. Synchronization normally requires explicit coordination among deploying forces and staffs, supporting units and staffs, a variety of civilian agencies, and the other services. Frequent and realistic joint exercises and training are the key to successful synchronization.

Speed

3-43. Commanders view force projection as a race between friendly forces and the enemy or situation. The side that achieves a decisive operational capability first seizes the initiative. Thus, it is not the velocity of individual stages or transportation means that is decisive; it is the combat ready force deployed in theater before the enemy is ready or the situation gets out of control.

3-44. Speed is more than miles per hour: it is the sustained momentum achieved with the complete complement of joint lift assets. The volume steadily delivered by ship can often outpace the pieces delivered by air in terms of operational capability. Speed is also the velocity of the entire force projection process, from planning to force closure. It depends on many factors, to include maximizing the other force projection characteristics. Some factors are established before deployment starts. Planning—exemplified in factors such as the existence of efficient planning tools and maintaining unit integrity—helps operations progress smoothly. Allocating resources to deployment training results in trained unit movement officers and preparation for safe and efficient loading. Submission of accurate reports, timely arrival of throughput enablers, delivering capabilities, and POD throughput combine precision, synchronization, and relevant information. These and other factors all contribute to speed.

Precision and Speed—VII Corps Deploys to Southwest Asia

The Army projects power to support joint operations quickly and on short notice. In November 1990, VII Corps shifted its mission from the defense of Western Europe to coalition operations in Southwest Asia. The Operation Desert Shield mission required VII Corps to conduct crisis action planning for an unfamiliar theater while task organizing with units from V Corps and CONUS. The headquarters developed TPFDD and cross-leveled personnel and equipment on the move to the seaports of embarkation. The corps support command created new CSS capabilities to replace nondeployable host nation support assets. The 3d Brigade, 1st Infantry Division, arrived in Southwest Asia early and established port support activities at Dammam and Jubayl in Saudi Arabia to assist VII Corps with RSO&I. VII Corps deployed over 35,000 soldiers from Europe to Southwest Asia and off-loaded over 6,000 tracked vehicles at the ports between November 1990 and February 1991. VII Corps units underwent technology modernization in theater, repainted their vehicles for desert warfare, and conducted numerous training exercises prior to executing Operation Desert Storm.

Relevant Information

3-45. Successful force projection requires commanders to combine knowledge of the deployment process, judgment, and relevant information. There is a short period in which deploying commanders make decisions that determine the conduct of the deployment and the available employment options over time. Many of the decisions are impossible or very hard to change. Making the right choices requires relevant information. For example, relevant information and understanding the TPFDD are imperative when establishing high-priority items, determining sequencing, deciding how to use time, and setting priorities. Relevant information concerning theater throughput allows commanders to manage deployment to enable employment. Relevant information does not guarantee a smooth deployment; however, combined with their experience and judgment, relevant information allows commanders to control the situation and make good decisions.

JOINT SYSTEMS

3-46. Force projection is an integral part of the Joint Operation Planning and Execution System (JOPES). JOPES is constantly evolving. It includes joint operation planning tools, policies, procedures, and reporting structures (see JP 5-03.1). Communications and automated data processing support the entire system. JOPES is used to monitor, plan, and execute mobilization, deployment, employment, sustainment, and redeployment activities associated with joint operations. It provides the framework within which JFCs design theater operations. Army force projection is nested within this framework. The global command and control system (GCCS) is the worldwide automated network of systems that supports JOPES. Army commanders ensure that unit data provided to GCCS databases is accurate. Up-to-date information allows joint planners to produce timely, efficient, and accurate force projection estimates and plans. Several deployment planning tools under development, such as the Transportation Coordinators Automated Information for Movement System II (TC-AIMS II) and the Joint Force Requirements Generator II (JFRG II), will enhance the deployment process and accelerate TPFDD development.

Time-Phased Force Deployment Data

The TPFDD is the JOPES database portion of an operation plan. It contains time-phased force data, nonunit-related cargo and personnel data, and movement data for the operation plan. The TPFDD includes—

- In-place units.
- Units to be deployed.
- Desired sequence for arrival.
- Routing of forces to be deployed.
- Movement data.
- Estimates of nonunit-related cargo.
- Personnel movements to be conducted concurrently with the force deployments.

The TPFDD also contains estimates of common-user transportation requirements and requirements to be fulfilled by assigned or attached transportation resources.

3-47. A crisis for which no plan exists requires the JFC to rapidly develop a TPFDD. Standard contingency force packages support this time-sensitive

preparation cycle. While METT-TC may cause variations, tailored force packages contain a balanced mix of combat, CS, and CSS capabilities.

ENTRY OPERATIONS

3-48. When responding to a crisis, initial-entry forces often establish a lodgment area and expand it into a theater base. From the lodgment, US forces conduct RSO&I, reconfigure, build combat capability, and train. They also assist multinational and host nation forces, protect the force, and acclimate themselves. The JFC sequences combat and support units into the lodgment so that the force gains the initiative and completes deployment. Army forces always prepare for simultaneous deployment and employment. Even in stability operations and support operations, the force is prepared to defend or attack to retain the lodgment. Units may enter the theater in a variety of ways. They either enter unopposed or use force.

Unopposed Entry

3-49. Whenever possible, US forces seek unopposed entry, which may be either assisted or unassisted. *Assisted entry* requires the cooperation of the host nation. In assisted entry, initial entry Army forces are tailored to deploy efficiently and transition to follow-on operations quickly. The CSS package is tailored to take full advantage of the host nation assets. RSO&I focus on cooperative effort to expedite moving units to their tactical assembly areas. For example, Saudi Arabia provided extensive support to US forces during deployment for Operation Desert Shield.

3-50. Often, circumstances leading to deployment make it impossible for the host nation to provide secure facilities for US forces as they arrive. An entry operation in such a case is an *unassisted entry*. An example of an unassisted entry was the deployment of US forces to Haiti during Operation Uphold Democracy. In unassisted entries, JFCs deploy balanced combinations of combat, CS, and CSS forces. Forces with enough combat power to secure an adequate lodgment must be dispatched immediately. Initial-entry CSS forces must be included to establish and support RSO&I within the lodgment. Force sequencing for an unassisted entry is similar to that of a forcible entry.

Forcible Entry

3-51. A ***forcible entry*** is an offensive operation for seizing and holding a military lodgment in the face of armed opposition (see JP 3-18). Supported by joint firepower, forcible entry operations capitalize on strategic and operational mobility to surprise the enemy, seize a lodgment, and gain the initiative. Once the assault force seizes the lodgment, it normally defends to retain it while the JFC rapidly deploys additional combat power and sustainment by air and sea. When conditions are favorable, the JFC may combine a forcible entry with other offensive operations in a *coup de main*, achieving the strategic objectives in a simultaneous major operation. Operation Just Cause is an example of a forcible entry *coup de main*.

A *coup de main* is an offensive operation that capitalizes on surprise and simultaneous execution of supporting operations to achieve success in one swift stroke.

3-52. The Army maintains formidable forcible entry capabilities. There are three types of forcible entry operations: air assault, parachute assault, and amphibious assault. The Army specializes in parachute assault and air assault. The Marine Corps specializes in amphibious assault; Marines usually conduct air assaults as part of an amphibious operation. Air assaults and parachute assaults permit JFCs to introduce combat power very quickly. They accomplish this without the normal hindrances imposed by port, airfield, or beach restrictions. For example, an airborne or air assault force can be delivered in a matter of minutes. The entry force either resolves the situation or secures a lodgment for the rapid delivery of larger forces by aircraft or ships. The three forms of forcible entry complement each other. Combining all three may allow the JFC to immediately seize the strategic, operational, and tactical initiative.

3-53. Usually, forcible entry operations secure an initial lodgment that includes an airfield. Once secure, this airfield becomes the focal point for rapid reinforcement of the entry force by air-delivered combat, CS, and CSS units. When required, initial-entry forces expand the lodgment to include a port or suitable seaport of debarkation for follow-on forces. When the lodgment is secure, follow-on forces deploy into the lodgment.

3-54. Forcible entry operations are complex and always joint. Often only hours separate alert and deployment. The demands of simultaneous deployment and combat employment create a unique set of dynamics. Operations are carefully planned and rehearsed at training areas and in marshaling areas. In contrast to most strategic deployments, equipment is configured for immediate use; ammunition and fuel are stored on board. Joint and Army commanders carefully balance C2, combat, CS, and CSS assets to obtain the maximum combat power quickly. Wherever possible, the commanders exercise C2 from aircraft and ships and use air- and sea-based fire support assets. Doing this dedicates the available strategic lift to placing Army maneuver and sustainment forces on the ground. For example, the staff of an initial-entry force may orbit in specially equipped Air Force aircraft, while Navy and Air Force elements deliver precision strikes to support the force.

SECURITY OF FORCE PROJECTION OPERATIONS

3-55. Enemies possess the motives and means to interrupt the deployment flow. Threats to deploying forces may include advanced conventional weaponry, weapons of mass destruction, and various types of sea and land mines. Sea and air PODs are particularly vulnerable targets since they are the entry points for forces and equipment. POD operations involve relatively soft targets; in addition to military forces and materiel, host nation support personnel, contractors, and civilians may all be working there. Many of these lucrative targets are within the range of enemy forces. A successful attack on a POD can have a major impact on force projection momentum. Commanders at all levels focus attention on security actions that reduce vulnerabilities. To avoid threats to entry operations, the force may operate through ISBs.

INTERMEDIATE STAGING BASES

3-56. An *intermediate staging base* is a secure staging base established near to, but not in, the areas of operations (see Figure 3-5). ISBs

are temporary staging areas en route to an operation. They may also be used to sustain forces in the AO (see FM 4-0). In the best case, secure bases are available within the AO. Unfortunately, the situation that compels deployment may negate the advantages of basing within the AO. When deciding whether to operate through an ISB, JFCs weigh sustainment requirements against risks.

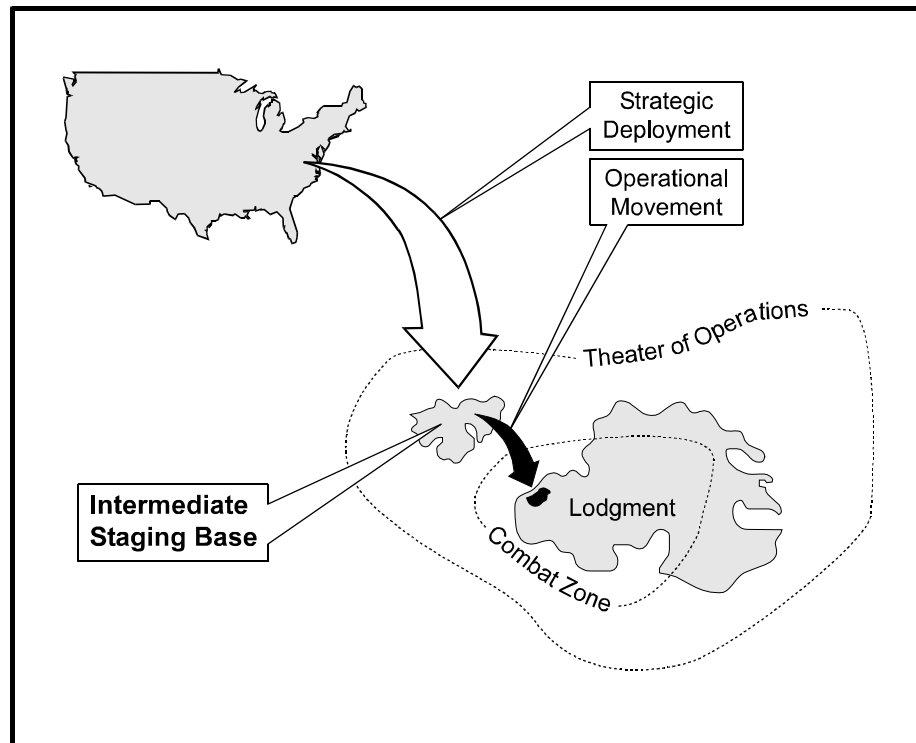

Figure 3-5. Intermediate Staging Base

3-57. ISBs are normally located within the theater of operations and outside the AO. They are established outside the range of enemy tactical and operational fires and beyond the enemy political sphere of influence. In cases where the force needs to secure a lodgment, an ISB may be critical to success. Using ISBs is not without a price. Because they are transshipment points, ISBs add handling requirements and can increase deployment time. They may also require infrastructure (personnel and equipment).

3-58. ISBs may serve as the principal staging base for entry operations. They take advantage of existing, sophisticated capabilities, serving as efficient transfer points from high volume commercial carriers to a variety of tactical, intratheater transport means. Tactical transports can serve smaller, austere ports or—with the right lift—bypass them. Upon arrival at an ISB, a force conducts limited RSO&I and configures for operations. The JFC can then project forces ready to conduct operations immediately into the AO. While not a requirement in every case, an ISB can provide a secure, high-throughput facility when circumstances call for it. ISBs are not limited to a single location; an ISB can consist of several points within a region. The capability and throughput of available facilities determine ISB configuration.

PART TWO

Foundations of Full Spectrum Operations

Part Two discusses the foundations of full spectrum operations: fundamentals, battle command, and conduct. Warfighting is complex, but its essence is simple, and may be distilled into five general rules: Army forces win on the offense; initiate combat on their terms—not their adversaries; gain and maintain the initiative; build momentum quickly; and win decisively.

The three chapters in this part provide the foundations for these rules and provide greater detail on aspects of how to think about operations.

Chapter 4 describes the range of Army operations, elements of combat power, principles of war, tenets of Army operations, operational framework, and Army capabilities. Army forces can be tailored to create combined arms teams able to mass complementary and reinforcing effects across the range of military operations—war and military operations other than war—at the strategic, operational, and tactical levels. The elements of combat power—maneuver, firepower, leadership, protection, and information—connect Army doctrine, organizations, and operations. Army commanders use the principles of war and the tenets of Army operations to apply the elements of combat power in decisive full spectrum operations. They use the operational framework to arrange their forces in time, space, purpose, and resources to accomplish the mission.

Chapter 5 examines battle command. Battle command is the application of leadership as an element of combat power. It involves four functions: visualizing, describing, directing, and leading. Commanders visualize an operation in terms of METT-TC, the elements of operational design, and their own experience and judgment. Commanders use the commander's intent and planning guidance to describe their vision. Commanders use the concept of operations and the seven battlefield operating systems to direct their forces. Throughout, commanders apply the art of command to lead their soldiers and organizations to success.

Chapter 6 describes the conduct of full spectrum operations in terms of the operations process. The operations process consists of the activities units perform as they conduct operations: planning, preparation, and execution with continuous assessment. It translates the commander's vision into action.

Chapter 4

Fundamentals of Full Spectrum Operations

The art of war owns certain elements and fixed principles. We must acquire that theory, and lodge it in our heads—otherwise, we will never get very far.

Frederick the Great

4-1. Doctrine for full spectrum operations depends upon certain fundamentals. These fundamentals provide the conceptual foundations for execution in the field as well as leader development in the classroom. They provide the basis for the efficient and effective generation, employment, and sustainment of Army forces. Ultimately, knowledge and application of the fundamentals enable Army forces to be decisive across the range of military operations.

4-2. The fundamentals provide the basis for full spectrum operations (see Figure 4-1). The *elements of combat power* are building blocks that

underlie the generation of combat power. In land operations, commanders combine and apply the elements of combat power to produce overwhelming effects. The *principles of war* guide and instruct commanders as they combine the elements of combat power. The principles reflect the distillation of Army experience into a set of time-tested guidelines. The *tenets of Army operations* characterize both the substance and form of full spectrum operations. The tenets permeate Army doctrine. The *operational framework* relates the activities of Army forces in time, space, and purpose. Combined with tenets of Army operations, the framework provides commanders with a conceptual basis for applying combat power. Commanders combine and use the capabilities of combined arms formations in complementary, reinforcing, and asymmetric ways. Combined arms organizations apply combat power to achieve decisive results across the range of operations.

CONTENTS

The Elements of Combat Power	4-3
Maneuver	4-4
Firepower	4-6
Leadership	4-7
Protection	4-8
Information	4-10
The Foundations of Army Operations	4-11
The Principles of War	4-11
The Tenets of Army Operations	4-15
The Operational Framework	4-18
Theater Organization	4-18
Area of Operations	4-19
Battlespace	4-20
Battlefield Organization	4-22
Army Capabilities	4-27
Task Organization	4-27
Combined Arms	4-27
Army Command and Support	
Relationships	4-29
Complementary and Reinforcing	
Effects	4-29
Asymmetry	4-31

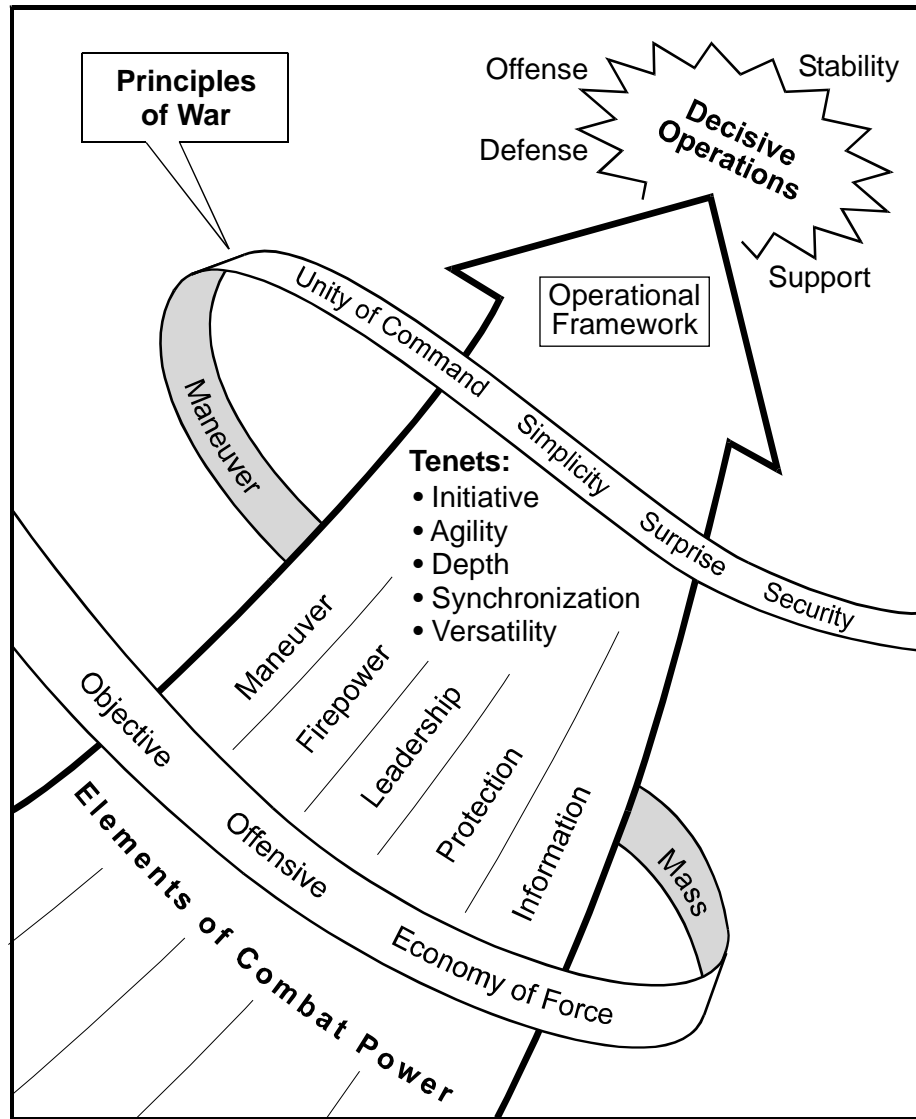

Figure 4-1. The Fundamentals of Full Spectrum Operations

THE ELEMENTS OF COMBAT POWER

4-3. The ability of Army forces to fight and win underlies success in all operations, whether lethal force is used or not. Combat power is the ability to fight. It is the total means of destructive or disruptive force, or both, that a military unit or formation can apply against the adversary at a given time. Commanders combine the elements of combat power—maneuver, firepower, leadership, protection, and information—to meet constantly changing requirements and defeat an enemy (see Figure 4-2, page 4-4). Defeating an enemy requires increasing the disparity between friendly and enemy forces by reducing enemy combat power. Commanders do this by synchronizing the elements of friendly force combat power to create overwhelming effects at the decisive time and place. Focused combat power ensures success and denies an enemy any chance to maintain coherent resistance. Massed effects created by

synchronizing the elements of combat power are the surest means of limiting friendly casualties and swiftly ending a campaign or operation.

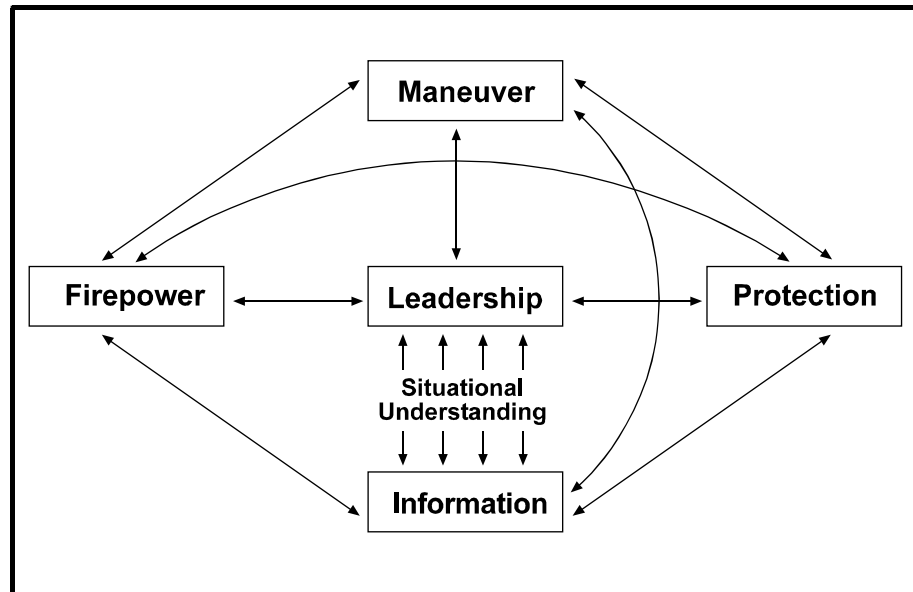

Figure 4-2. The Elements of Combat Power

MANEUVER

4-4. Maneuver is the employment of forces, through movement combined with fire or fire potential, to achieve a position of advantage with respect to the enemy to accomplish the mission. Maneuver is the means by which commanders concentrate combat power to achieve surprise, shock, momentum, and dominance.

Operational Maneuver

4-5. Operational maneuver involves placing Army forces and resources at the critical place in time to achieve an operational advantage. It is complex and often requires joint and multinational support. Deployment and intratheater movements are operational maneuver if they achieve a positional advantage and influence the outcome of a campaign or battle.

4-6. To achieve operational results, commanders seek operational advantages of position before combat begins and exploit tactical success afterwards. Ideally, operational maneuver secures positional advantage before an enemy acts and either preempts enemy maneuver or ensures his destruction if he moves. Operational movements and maneuver allow commanders to create the conditions they desire for battle and take full advantage of tactical actions. During Operation Desert Storm, for example, US Central Command (USCENTCOM) moved VII and XVIII Corps west of Kuwait to position them to envelop or turn the strongest Iraqi defenses. This undetected operational movement resulted in surprise at both the operational and tactical levels. This surprise, combined with rapid tactical movement and overwhelming combat power, resulted in the decisive defeat of the Iraqi army.

Tactical Maneuver

4-7. Tactical maneuver wins battles and engagements. By keeping the enemy off balance, it also protects the force. In both the offense and defense, it positions forces to close with and destroy the enemy. Effective tactical maneuver continually poses new problems for the enemy. It renders his reactions ineffective and eventually drives him to defeat.

4-8. In stability operations, effective tactical maneuver preempts adversary options. It concentrates friendly combat power where it can deter or reduce the effects of violence and places friendly forces in position to use firepower should combat follow. Tactical maneuver gives credibility to an operation by providing tangible evidence of Army force capabilities. In support operations, maneuver positions Army forces to apply their capabilities where they are needed.

Close Combat

4-9. Close combat is inherent in maneuver and has one purpose—to decide the outcome of battles and engagements. ***Close combat is combat carried out with direct fire weapons, supported by indirect fire, air-delivered fires, and nonlethal engagement means. Close combat defeats or destroys enemy forces, or seizes and retains ground.*** The range between combatants may vary from several thousand meters to hand-to-hand combat.

Close Combat at Landing Zone X-Ray

On 14 November 1965, soldiers from the 1st Battalion, 7th Cavalry engaged in close combat with North Vietnamese Army (NVA) forces in the Ia Drang Valley, Republic of Vietnam.

Specialist 5 Marlin T. Dorman recalled hugging the ground because “if you moved you got hit.” He noted that “our training really showed then. We shifted into defensive positions. We had five men killed in 25 minutes. Then all of a sudden they [the NVA] tried a mass assault from three directions, rushing from bush to bush and laying fire on us. We put our M-16s on full automatic and killed most of them.” Specialist 4 Galen Bungum added, “We gathered up all the full magazines we could find and stacked them up in front of us. There was no way we could dig a foxhole. The handle was blown off my entrenching tool and one of my canteens had a hole blown through it. The fire was so heavy that if you tried to raise up to dig you were dead. There was death and destruction all around.”

On the third morning of heavy fighting, the NVA tried one last attempt to break through the battalion perimeter. Under the light of flares, the NVA massed 50 yards in front of the American positions and ran forward. The soldiers responded with air burst field artillery shells, mortar rounds, machine guns, and small arms. After 14 minutes of continuous combat, the NVA force broke off the attack and ended the three-day battle at Landing Zone X-Ray.

4-10. All tactical actions inevitably require seizing or securing terrain as a means to an end or an end in itself. Close combat is necessary if the enemy is skilled and resolute; fires alone will neither drive him from his position nor convince him to abandon his cause. Ultimately, the outcome of battles, major operations, and campaigns depends on the ability of Army forces to close with and destroy the enemy. During offensive and defensive operations, the certainty of destruction may persuade the enemy to yield. In stability operations, close combat dominance is the principal means Army forces use to influence adversary actions. In all cases, the ability of Army forces to engage in close combat, combined with their willingness to do so, is the decisive factor in defeating an enemy or controlling a situation.

FIREPOWER

4-11. Firepower provides the destructive force essential to overcoming the enemy's ability and will to fight. Firepower and maneuver complement each other. Firepower magnifies the effects of maneuver by destroying enemy forces and restricting his ability to counter friendly actions; maneuver creates the conditions for the effective use of firepower. Although one element might dominate a phase of an action, the synchronized effects of both are present in all operations. The threat of one in the presence of the other magnifies the impact of both. One without the other makes neither decisive. Combined, they make destroying larger enemy forces feasible and enhance protection of friendly forces.

4-12. Firepower is the amount of fires that a position, unit, or weapons system can deliver. Fires are effects of lethal and nonlethal weapons. Fires include fire support functions used separately from or in combination with maneuver. The extended range, capabilities, and accuracy of modern weapons systems (direct and indirect) and target acquisition systems make fires more lethal than ever before. These capabilities also allow commanders to create effects throughout the area of operations (AO). Commanders integrate and synchronize operational and tactical fires to accomplish their mission.

Operational Fires

4-13. **Operational fires are the operational-level commander's application of nonlethal and lethal weapons effects to accomplish objectives during the conduct of a campaign or major operation.** They are a vital component of any operational-level plan. Assets other than those supporting tactical maneuver normally furnish operational fires. Commanders direct operational fires against targets whose destruction or neutralization they expect to significantly affect a campaign or major operation. Planning operational fires includes allocating apportioned joint and multinational air, land, and sea means. Operational fires can be designed to achieve a single operational-level objective, for example, interdiction of major enemy forces to create the conditions for defeating them in detail.

4-14. Operational maneuver and operational fires may occur simultaneously but have very different objectives. In general terms, operational fires are not the same as fire support, and operational maneuver does not necessarily depend on operational fires. However, operational maneuver is most effective when commanders synchronize it with, and exploit opportunities developed

by, operational fires. Combining operational fires with operational maneuver generates asymmetric, enormously destructive, one-sided battles, as the Desert Storm ground offensive showed.

Tactical Fires

4-15. Tactical fires destroy or neutralize enemy forces, suppress enemy fires, and disrupt enemy movement. Tactical fires create the conditions for decisive close combat. Commanders take special care to synchronize fires with the effects of other systems. Massing maximum fires requires a thorough understanding of the commander's intent and the ability to employ all available means simultaneously against a variety of targets. The effective application of tactical fires relies on procedures for determining priorities; locating, identifying, and tracking targets; allocating firepower assets; and assessing effects. Effective fires demand well-trained, competently led units with a high degree of situational understanding.

Operational Maneuver and Fires—Operation Desert Storm

On 27 February 1991, Operation Desert Storm demonstrated how operational fires and maneuver can generate a one-sided, decisive battle. The campaign plan identified the Iraqi Army, a force whose elimination would decisively conclude the war, as the operational center of gravity.

XVIII Airborne Corps turned Objective Tim into Forward Operating Base Viper and launched two aviation brigades into Engagement Area Thomas, north of Basrah. There they destroyed over 80 Iraqi vehicles. To the south, the corps pushed eastward. They seized Jalibah Airfield and moved at speeds approaching 40 miles per hour as they overran and destroyed Iraqi forces.

After destroying the Iraqi Tawakalna mechanized and Medina armored divisions, VII Corps pressed an attack that destroyed more than 100 tanks and armored personnel carriers just short of the Kuwaiti border. British forces under operational control of the corps pressed the attack beyond the Basrah-Kuwait City highway to the coast. The remaining Iraqi forces fled encircling coalition forces for sanctuary across the Euphrates River.

LEADERSHIP

4-16. Because it deals directly with soldiers, leadership is the most dynamic element of combat power. Confident, audacious, and competent leadership focuses the other elements of combat power and serves as the catalyst that creates conditions for success. Leaders who embody the warrior ethos inspire soldiers to succeed. They provide purpose, direction, and motivation in all operations. Leadership is key, and the actions of leaders often make the difference between success and failure, particularly in small units.

4-17. The duty of every leader is to be competent in the profession of arms. Competence requires proficiency in four sets of skills: interpersonal, conceptual, technical, and tactical. Army leaders hone these skill sets through continual training and self-study (see FM 6-22).

4-18. Leaders instill their units with Army values, energy, methods, and will. The professional competence, personality, and will of strong commanders at all levels represent a significant part of every unit's combat power. All Army leaders must demonstrate strong character and high ethical standards. Leaders are soldiers first: they know and understand their subordinates and act with courage and conviction. During operations, they know where to be, when to make decisions, and how to influence the action.

4-19. Leaders build teamwork and trust. Trust is a key attribute in the human dimension of combat leadership. Soldiers must trust and have confidence in their leaders. Leaders must command the trust and confidence of their soldiers. Once trust is violated, a leader becomes ineffective. Trust encourages subordinates to seize the initiative. In unclear situations, bold leaders who exercise disciplined initiative within the commander's intent accomplish the mission.

PROTECTION

4-20. **Protection is the preservation of the fighting potential of a force so the commander can apply maximum force at the decisive time and place.** Protection is neither timidity, nor risk avoidance. The Army operates in tough, unforgiving environments where casualties occur. Full spectrum operations create an inherently tense relationship between accomplishing the mission and taking casualties. Accomplishing the mission takes precedence over avoiding casualties. However, soldiers are the most important Army resource, and excessive casualties cripple future mission accomplishment. Casualties from accident and disease are particularly galling. They contribute nothing to mission accomplishment and degrade unit effectiveness. Commanders are responsible for accomplishing the mission with the fewest friendly casualties feasible.

4-21. Protection has four components: force protection, field discipline, safety, and fratricide avoidance. Force protection, the primary component, minimizes the effects of enemy firepower (including weapons of mass destruction [WMD]), maneuver, and information. Field discipline precludes losses from hostile environments. Safety reduces the inherent risk of nonbattle deaths and injuries. Fratricide avoidance minimizes the inadvertent killing or maiming of soldiers by friendly fires.

Force Protection

4-22. **Force protection consists of those actions taken to prevent or mitigate hostile actions against DOD personnel (to include family members), resources, facilities, and critical information. These actions conserve the force's fighting potential so it can be applied at the decisive time and place and incorporates the coordinated and synchronized offensive and defensive measures to enable the effective employment of the joint force while degrading opportunities for the enemy. Force protection does not include actions to defeat the enemy or protect against accidents, weather, or disease.** It includes air, space, and missile defense; nuclear, biological, and chemical defense; antiterrorism; defensive information operations; and security to operational forces and means. The increased emphasis on force protection at every

echelon stems from the conventional dominance of Army forces. Often unable to challenge the Army in conventional combat, adversaries seek to frustrate Army operations by resorting to asymmetric means, weapons, or tactics. Force protection counters these threats.

4-23. Force protection at all levels minimizes losses to hostile action. Skillful and aggressive counterintelligence and threat assessments decrease the vulnerability of friendly forces. Effective operations security (OPSEC) keeps adversaries from exploiting friendly information. Proper dispersion helps reduce losses from enemy fires and terrorist action. Camouflage discipline, local security, and field fortifications do the same. Protection of electronic links and nodes, to include combat troops with electronic devices, is vital to protecting information, information systems, and soldiers. At the operational level, rear area and base security contributes to force protection. Air defense artillery forces protect installations and civilian populations from over-the-horizon strikes by conventional warheads and WMD. Army air and missile defense units complement the air component's control of the air. Nuclear, biological, and chemical (NBC) defense measures provide the capability to sustain operations in nuclear, biological, or chemical environments.

Field Discipline

4-24. Field discipline, a second component of protection, guards soldiers from the physical and psychological effects of the environment. Oppressive environments can sap soldier strength and morale far more quickly than enemy action. Soldiers can adapt to the point that they outperform indigenous populations; however, this adaptation can only stem from training in fieldcraft skills and thorough preparation.

Field Discipline—Preventive Medicine in Combat

In the 1898 war with Spain, the US mobilized the Army and sent soldiers to fight in Cuba, the Philippines, and Puerto Rico. Combat claimed 379 American lives. Well over 10 times that number were lost to disease. Almost 1,000 soldiers died from typhoid fever and diarrhea in crowded, filthy training camps in the US. Once in the tropics, malaria and yellow fever increased the disease-related deaths to several thousand. The resulting scandal led to efforts to reform the War Department.

Nearly a century after the Spanish-American War, the US conducted contingency operations in Panama (1989-90) and Haiti (1994-96). In both cases, combat casualties were minimal, while deaths from disease were nonexistent. Today, good leadership, the advanced state of medical knowledge, formalized measures designed to prevent disease, and first-rate medical treatment ensure that US troops sent overseas are among the healthiest in the world.

4-25. Commanders take every measure and precaution to keep soldiers healthy and maintain their morale. Such actions include securing equipment and supplies from loss or damage. Commanders ensure systems are in place for adequate combat health support (to include preventive medicine) and the

quick return of minor casualties. They provide effective systems for maintenance, evacuation, and rapid replacement or repair of equipment. Tactical commanders take care of their soldiers' basic health needs and prevent unnecessary exposure to debilitating conditions.

Safety

4-26. Safety is a third component of protection. Operational conditions often impose significant risks to soldiers' lives and health and make equipment operation difficult. Trained crews and operators must know the capabilities and limitations of their weapons systems. Commanders must know how to employ them. In designing operations, commanders consider the limits of human endurance. They balance the possible benefits of sustained, high-tempo operations with the risks involved. In combat, fatigue extends reaction times and reduces alertness. Fatal accidents, loss of combat power, and missed tactical opportunities may follow. Command attention to safety and high levels of discipline lessen those risks, particularly as soldiers become exhausted. Safe operations come from enforcing standards during training. While taking calculated risks is inherent in operations, commanders are obligated to embed safety in the conduct of all operations.

Fratricide Avoidance

4-27. A fourth component of protection is fratricide avoidance. ***Fratricide is the unintentional killing or wounding of friendly personnel by friendly firepower.*** The destructive power and range of modern weapons, coupled with the high intensity and rapid tempo of combat, increase the potential for fratricide. Tactical maneuvers, terrain, and weather conditions may also increase the danger of fratricide. Commanders seek to lower the probability of fratricide without discouraging boldness and audacity. Good leadership resulting in positive weapons control, control of troop movements, and disciplined operational procedures contributes to achieving this goal. Situational understanding and using friendly personnel and vehicle identification methods also help. Eliminating fratricide increases soldiers' willingness to act boldly, confident that misdirected friendly fires will not kill them.

INFORMATION

4-28. Information enhances leadership and magnifies the effects of maneuver, firepower, and protection. In the past, when forces made contact with the enemy, commanders developed the situation to gain information. Today, Army leaders use information collected by unmanned systems to increase their situational understanding before engaging the enemy. They also use offensive information operations (IO) to shape the operational environment and create the conditions for employing the other elements of combat power.

4-29. The common operational picture (COP) based on enhanced intelligence, surveillance, and reconnaissance (ISR) and disseminated by modern information systems provides commanders throughout the force with an accurate, near real-time perspective and knowledge of the situation. Information from the COP, transformed into situational understanding, allows commanders to combine the elements of combat power in new ways. For example, superior understanding of the situation allows commanders to avoid enemy

engagement areas, while concentrating fires and maneuver at the decisive place and time. This ability increases the survivability of the force without substantially increasing passive protective systems, such as armor. Modern information systems help leaders at all levels make better decisions faster. Better decisions rapidly communicated allow Army forces to mass the effects of combat power more rapidly and effectively than the enemy. This enables Army forces to see first, understand first, and act first.

4-30. Information is not neutral; opposing sides use it directly and indirectly to gain exploitable advantages and apply them against selected targets. Just as fires are synchronized and targeted, so is information. Some examples illustrate the use of information as an element of combat power: In 1989 during Operation Just Cause, and again in 1991 during Operation Desert Storm, psychological operations (PSYOP) units accompanied maneuver forces. In both conflicts, PSYOP, combined with the demonstrated destructive power of Army forces, convinced many enemy troops to surrender. In Operation Desert Storm, military deception (an element of offensive IO) resulted in the diversion of forces away from USCENTCOM's decisive operation.

Information Modernization— AH-64D Longbow

The AH-64D attack helicopter represents the wave of integrated digital weapons systems now entering service. The aircraft provides the commander with digital links to the ground and air situation. Its computer shares the situational picture with all other aircraft on the mission. The radar fire control system on the aircraft can scan, detect, and classify more than 128 targets, prioritize the 16 most dangerous ones, transmit the information to other aircraft, and initiate a precision attack—all in less than a minute.

4-31. Army forces are modernizing information systems to an unprecedented degree. This effort will have far-reaching effects on Army operations. The aim of these improvements is to provide all leaders with near real-time information that will allow them to understand the tactical situation and act within the commander's intent. This increased capability poses operational challenges. While subordinates have access to the broader tactical situation, commanders have access to layers of tactical detail. Higher-level commanders yielding to the temptation to direct minor tactical actions could reduce the benefits of advanced information systems and the situational understanding they support.

THE FOUNDATIONS OF ARMY OPERATIONS

4-32. Understanding the principles of war and tenets of Army operations is fundamental to operating successfully across the range of military operations. The principles of war and tenets of Army operations form the foundation of Army operational doctrine.

THE PRINCIPLES OF WAR

4-33. The nine principles of war provide general guidance for conducting war and military operations other than war at the strategic, operational, and

tactical levels. The principles are the enduring bedrock of Army doctrine. The US Army published its original principles of war after World War I. In the following years, the Army adjusted the original principles, but overall they have stood the tests of analysis, experimentation, and practice.

4-34. The principles of war are not a checklist. They do not apply in the same way to every situation. Rather, they summarize the characteristics of successful Army operations. Their greatest value lies in the education of the military professional. Applied to the study of past campaigns, major operations, battles, and engagements, the principles of war are powerful tools for analysis.

The Principles of War

- Objective
- Offensive
- Mass
- Economy of force
- Maneuver
- Unity of command
- Security
- Surprise
- Simplicity

Objective

Direct every military operation toward a clearly defined, decisive, and attainable objective.

4-35. At the operational and tactical levels, objective means ensuring all actions contribute to the goals of the higher headquarters. The principle of objective drives all military activity. When undertaking any mission, commanders should have a clear understanding of the expected outcome and its impact. At the strategic level, this means having a clear vision of the theater end state. This normally includes aspects of the political dimension. Commanders need to appreciate political ends and understand how the military conditions they achieve contribute to them.

No one starts a war—or rather, no one in his senses ought to do so—without first being clear in his mind what he intends to achieve by that war.

Clausewitz

4-36. Military leaders cannot divorce objective from considerations of restraint and legitimacy, particularly in stability operations and support operations. The amount of force used to obtain the objective must be prudent and appropriate to strategic aims. The military objective must also sustain the willing acceptance of a lawfully constituted agency, group, or government by the population in the AO. Without restraint or legitimacy, support for military action deteriorates and the objective becomes unobtainable.

4-37. To accomplish missions, commanders persevere. Offensive and defensive operations may swiftly create the conditions for short-term success, but protracted stability operations or support operations may be needed to cement lasting strategic objectives. Commanders balance a natural desire to enter the AO, quickly accomplish the mission, and depart with the broader requirements for incremental achievement of national goals and objectives.

Offensive

Seize, retain, and exploit the initiative.

4-38. Offensive action is key to achieving decisive results. It is the essence of successful operations. Offensive actions are those taken to dictate the nature, scope, and tempo of an operation. They force the enemy to react. Commanders use offensive actions to impose their will on an enemy, adversary, or situation. Offensive operations are essential to maintain the freedom of action necessary for success, exploit vulnerabilities, and react to rapidly changing situations and unexpected developments.

Mass

Concentrate the effects of combat power at the decisive place and time.

4-39. Commanders mass the effects of combat power to overwhelm enemies or gain control of the situation. They mass combat power in time and space to achieve both destructive and constructive results. Massing in time applies the elements of combat power against multiple targets simultaneously. Massing in space concentrates the effects of different elements of combat power against a single target. Both dominate the situation; commanders select the method that best fits the circumstances. To an increasing degree, joint and Army operations mass the full effects of combat power in both time and space, rather than one or the other. Such effects overwhelm the entire enemy defensive system before he can react effectively.

4-40. Army forces can mass effects without concentrating forces to a far greater extent than in the past. They can also mass effects more quickly. This does not imply that Army forces accomplish their missions with fires alone. Swift and fluid maneuver supported by situational understanding complement firepower. Often, this combination accomplishes in a single operation what formerly took an entire campaign.

4-41. Commanders mass the effects of combat power against a combination of elements critical to the enemy force to shatter its coherence. Some of these may be concentrated and vulnerable to operations that mass in both time and space. Others may spread throughout the AO, vulnerable only to simultaneous, nonlinear operations that mass in time only. Commanders combine simultaneous and sequential operations to mass effects in time and space.

Economy of Force

Allocate minimum essential combat power to secondary efforts.

4-42. Economy of force is the reciprocal of mass. It requires accepting prudent risk in selected areas to achieve superiority—overwhelming effects—in the decisive operation. Economy of force involves the discriminating employment and distribution of forces. Commanders never leave any element without a purpose. When the time comes to execute, all elements should have tasks to perform.

Maneuver

Place the enemy in a disadvantageous position through the flexible application of combat power.

4-43. As both an element of combat power and a principle of war, maneuver concentrates and disperses combat power to place and keep the enemy at a disadvantage. It achieves results that would otherwise be more costly. Effective maneuver keeps enemies off balance by making them confront new problems and new dangers faster than they can deal with them. Army forces gain and preserve freedom of action, reduce vulnerability, and exploit success through maneuver. Maneuver is more than just fire and movement. It includes the dynamic, flexible application of leadership, firepower, information, and protection as well. It requires flexibility in thought, plans, and operations and the skillful application of mass, surprise, and economy of force.

Unity of Command

For every objective, ensure unity of effort under one responsible commander.

4-44. Developing the full combat power of a force requires unity of command. Unity of command means that a single commander directs and coordinates the actions of all forces toward a common objective. Cooperation may produce coordination, but giving a single commander the required authority unifies action.

4-45. The joint, multinational, and interagency nature of unified action creates situations where the military commander does not directly control all elements in the AO. In the absence of command authority, commanders cooperate, negotiate, and build consensus to achieve unity of effort (see JP 3-0; FM 6-22).

Security

Never permit the enemy to acquire an unexpected advantage.

4-46. Security protects and preserves combat power. It does not involve excessive caution. Calculated risk is inherent in conflict. Security results from measures taken by a command to protect itself from surprise, interference, sabotage, annoyance, and threat ISR. Military deception greatly enhances security. The threat of asymmetric action requires emphasis on security, even in low-threat environments (see FM 3-13; FM 3-90; FM 3-07.2).

Surprise

Strike the enemy at a time or place or in a manner for which he is unprepared.

4-47. Surprise is the reciprocal of security. Surprise results from taking actions for which an enemy or adversary is unprepared. It is a powerful but temporary combat multiplier. It is not essential to take the adversary or enemy completely unaware; it is only necessary that he become aware too late to react effectively. Factors contributing to surprise include speed, information superiority, and asymmetry.

Simplicity

Prepare clear, uncomplicated plans and clear, concise orders to ensure thorough understanding.

4-48. Plans and orders should be simple and direct. Simple plans and clear, concise orders reduce misunderstanding and confusion. The factors of METT-TC determine the degree of simplicity required. Simple plans executed on time are better than detailed plans executed late. Commanders at all levels weigh the apparent benefits of a complex concept of operations against the risk that subordinates will not be able to understand or follow it.

4-49. Multinational operations put a premium on simplicity. Differences in language, doctrine, and culture complicate multinational operations. Simple plans and orders minimize the confusion inherent in this complex environment. The same applies to operations involving interagency and nongovernmental organizations.

THE TENETS OF ARMY OPERATIONS

4-50. The tenets of Army operations—initiative, agility, depth, synchronization, and versatility—build on the principles of war. They further describe the characteristics of successful operations. These tenets are essential to victory. While they do not guarantee success, their absence risks failure.

Initiative

4-51. Initiative has both operational and individual components. From an operational perspective, ***initiative is setting or dictating the terms of action throughout the battle or operation.*** Initiative implies an offensive spirit in all operations. To set the terms of battle, commanders eliminate or reduce the number of enemy options. They compel the enemy to conform to friendly operational purposes and tempo, while retaining freedom of action. Army leaders anticipate events throughout the battlespace. Through effective command and control (C2), they enable their forces to act before and react faster than the enemy does.

4-52. From an individual perspective, initiative is the ability to be a self-starter, to act when there are no clear instructions or when the situation changes. An individual leader with initiative is willing to decide and initiate independent actions when the concept of operations no longer applies or when an unanticipated opportunity leading to the accomplishment of the commander's intent presents itself (see FM 6-22). Despite advances in C2 from digital technology, individual initiative remains important for successful operations. In battle, leaders exercise this attribute when they act independently within the framework of the commander's intent. They trust their subordinates to do the same. Disciplined initiative requires well-trained and competent leaders who carry out studied and considered actions.

4-53. Initiative requires delegating decision making authority to the lowest practical level. Commanders give subordinates the greatest possible freedom to act. They encourage aggressive action within the commander's intent by issuing mission-type orders. Mission-type orders assign tasks to subordinates without specifying how to accomplish them (see FM 6-0). Such decentralization frees commanders to focus on the critical aspects of the overall operation.

Using mission-type orders requires individual initiative exercised by well-trained, determined, disciplined soldiers. It also requires leaders who trust their subordinates and are willing to take and underwrite risks.

4-54. In the offense, initiative involves throwing the enemy off balance with powerful, unexpected strikes. It implies never allowing the enemy to recover from the initial shock of an attack. To do this, commanders mass the effects of combat power and execute with speed, audacity, and violence. They continually seek vulnerable spots and shift their decisive operation when opportunities occur. To retain the initiative, leaders press the fight tenaciously and aggressively. They accept risk and push soldiers and systems to their limits. Retaining the initiative requires planning beyond the initial operation and anticipating possible events. The higher the echelon, the more possibilities the commander must anticipate and the further in advance the staff must plan.

4-55. In the defense, initiative implies quickly turning the tables on the attacker. It means taking aggressive action to collect information and force the attacker to reveal his intentions. Defenders aim to negate the attacker's initial advantages, gain freedom of action, and force the enemy to fight on the defender's terms. Once an enemy commits to a course of action, defending forces continue to seek offensive opportunities. They use maneuver and firepower to dictate the tempo of the fight and preempt enemy actions.

4-56. In stability operations, initiative contributes to influence over factions. It establishes conditions conducive to political solutions and disrupts illegal activities. For instance, commanders may establish conditions in which belligerent factions can best achieve their interests by remaining peaceful. Other examples of exercising initiative include defusing complicated crises, recognizing and preempting inherent dangers before they occur, and resolving grievances before they ignite open hostilities.

4-57. To gain and maintain the initiative in support operations, commanders develop a comprehensive understanding of the situation and anticipate requirements. Doing these things allows massing of resources to mitigate and prevent the effects of disasters. Commanders can then contribute to relieving suffering, managing consequences, and providing essential services.

Agility

4-58. **Agility is the ability to move and adjust quickly and easily.** It springs from trained and disciplined forces. Agility requires that subordinates act to achieve the commander's intent and fight through any obstacle to accomplish the mission.

4-59. Operational agility stems from the capability to deploy and employ forces across the range of Army operations. Army forces and commanders shift among offensive, defensive, stability, and support operations as circumstances and missions require. This capability is not merely physical; it requires conceptual sophistication and intellectual flexibility.

4-60. Tactical agility is the ability of a friendly force to react faster than the enemy. It is essential to seizing, retaining, and exploiting the initiative.

Agility is mental and physical. Agile commanders quickly comprehend unfamiliar situations, creatively apply doctrine, and make timely decisions.

Depth

4-61. **Depth is the extension of operations in time, space, and resources.** Commanders use depth to obtain space for effective maneuver, time to conduct operations, and resources to achieve and exploit success. Depth enables momentum in the offense, elasticity in the defense, and staying power in all operations.

4-62. In the offense and defense, depth entails attacking the enemy throughout the AO—simultaneously when possible, sequentially when necessary—to deny him freedom to maneuver. Offensive depth allows commanders to sustain momentum and press the fight. Defensive depth creates opportunities to maneuver against the enemy from multiple directions as attacking forces are exposed or discovered.

4-63. In stability operations and support operations, depth extends influence in time, space, purpose, and resources to affect the environment and conditions. In stability operations, ISR combined with IO help commanders understand factional motives, identify power centers, and shape the environment. In support operations, depth in resources, planning, and time allows commanders to stop suffering and prevent or slow the spread of disease.

4-64. In all operations, staying power—depth of action—comes from adequate resources. Depth of resources in quantity, positioning, and mobility is critical to executing military operations. Commanders balance depth in resources with agility. A large combat service support (CSS) tail can hinder maneuver, but inadequate CSS makes the force fragile and vulnerable.

Synchronization

4-65. **Synchronization is arranging activities in time, space, and purpose to mass maximum relative combat power at a decisive place and time.** Without synchronization, there is no massing of effects. Through synchronization, commanders arrange battlefield operating systems to mass the effects of combat power at the chosen place and time to overwhelm an enemy or dominate the situation. Synchronization is a means, not an end. Commanders balance synchronization against agility and initiative; they never surrender the initiative or miss a decisive opportunity for the sake of synchronization.

4-66. Some activities—such as electronic warfare, suppressing enemy air defenses, and shifting maneuver forces—might occur before the decisive operation. They may take place at locations distant from each other. Though separated in time and space, commanders closely synchronize such actions to mass overwhelming effects at the decisive time and place. Synchronization often requires explicit coordination and rehearsals among participants.

Versatility

4-67. **Versatility is the ability of Army forces to meet the global, diverse mission requirements of full spectrum operations.** Competence in a variety of missions and skills allows Army forces to quickly transition

from one type of operation to another with minimal changes to the deployed force structure. Versatility depends on adaptive leaders, competent and dedicated soldiers, and well-equipped units. Effective training, high standards, and detailed planning also contribute. Time and resources limit the number of tasks any unit can perform well. Within these constraints, commanders maximize versatility by developing the multiple capabilities of units and soldiers. Versatility contributes to the agility of Army units.

4-68. Versatility is a characteristic of multifunctional units. Commanders can take advantage of this by knowing each unit's capabilities and carefully tailoring forces for each mission. Military police, for example, can provide a mobile, lethal show of force, restore civil order, process detainees, and support peacekeeping operations. Engineer units can rebuild infrastructure, construct ports and base camps, and maintain lines of communications (LOCs). At higher echelons, versatility implies the ability to assume more complex responsibilities. For example, a corps headquarters can serve as an ARFOR headquarters or, with augmentation, a joint task force headquarters.

THE OPERATIONAL FRAMEWORK

4-69. **The *operational framework* consists of the arrangement of friendly forces and resources in time, space, and purpose with respect to each other and the enemy or situation. It consists of the area of operations, battlespace, and the battlefield organization.** The framework establishes an area of geographic and operational responsibility, and provides a way for commanders to visualize how to employ forces against the enemy. Commanders design an operational framework to accomplish their mission by defining and arranging its three components. They use the operational framework to focus combat power.

THEATER ORGANIZATION

4-70. The operational framework for Army forces rests within the combatant commander's theater organization. Combatant commanders with geographic responsibilities conduct operations within an area of responsibility (AOR) (theater) assigned by the Unified Command Plan. When warranted, they designate theaters of war, theaters of operations, combat zones, and a communications zone (COMMZ). Joint force commanders (JFCs) at all levels may establish subordinate operational areas (see Figure 4-3). Joint doctrine discusses the assignment and responsibilities associated with theater operational areas.

4-71. Either the National Command Authorities or a combatant commander may designate a theater of war. It is the area of air, land, and water that is, or may become, directly involved in the conduct of the war. A theater of war does not normally encompass a combatant commander's entire AOR and may contain more than one theater of operations. Combatant commanders typically assign theaters of operations to subordinate unified commanders.

4-72. A theater of operations is a subarea within a theater of war defined by a combatant commander required to conduct or support specific combat operations. Different theaters of operations within the same theater of war will normally be geographically separate and focused on different enemy

forces. Theaters of operations are usually of significant size, allowing for operations over extended periods of time.

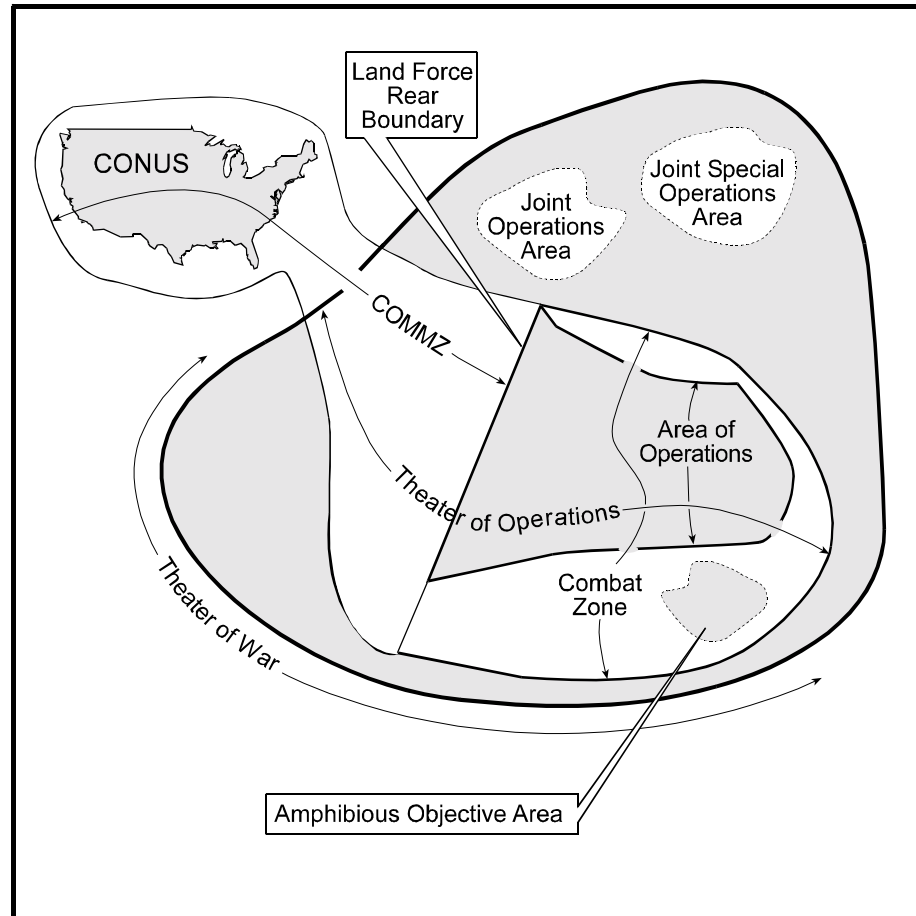

Figure 4-3. Theater Organization

4-73. A combat zone is that area required by combat forces for the conduct of operations. It normally extends forward from the land force rear boundary. The COMMZ is the rear part of theater of operations (behind but contiguous to the combat zone). It contains the LOCs, establishments for supply and evacuation, and other agencies required for the immediate support and maintenance of the field forces. It reaches back to the continental US, to a supporting combatant command AOR, or both.

AREA OF OPERATIONS

4-74. An AO is an operational area defined by the JFC for land and naval forces. AOs do not typically encompass the entire operational area of the JFC but should be large enough for component commanders to accomplish their missions and protect their forces. AOs should also allow component commanders to employ their organic, assigned, and supporting systems to the limits of their capabilities. Within their AOs, land and naval force commanders synchronize operations and are supported commanders.

4-75. Component commanders normally designate AOs for subordinate units. They use control measures to describe AOs and design them to fit the situation and take advantage of joint force capabilities. Commanders specify the minimum control measures necessary to focus combat power, delineate responsibilities, assign geographic responsibility, and promote unified action. At a minimum, control measures include boundaries on all sides of an AO (see FM 3-90). In linear operations, AOs require forward boundaries.

4-76. Commanders typically subdivide some or all of their AO by assigning AOs to subordinate units. Subordinate unit AOs may be contiguous or noncontiguous (see Figure 4-4). When AOs are contiguous, a boundary separates them. When AOs are noncontiguous, they do not share a boundary; the concept of operations links the elements of the force. The higher headquarters is responsible for the area between noncontiguous AOs.

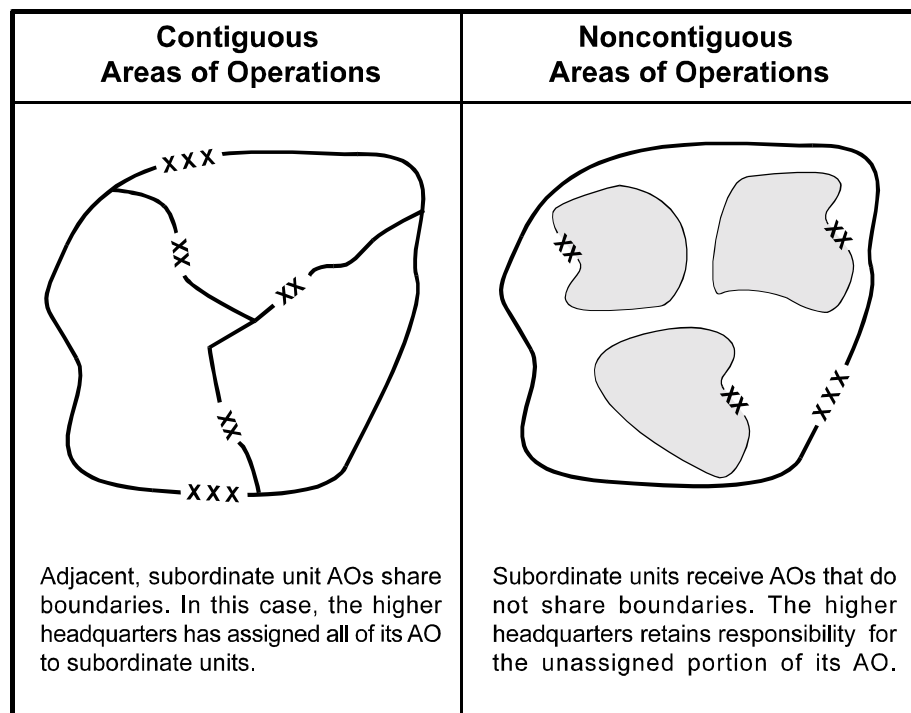

Figure 4-4. Contiguous and Noncontiguous Areas of Operations

BATTLESPACE

4-77. Battlespace is the environment, factors, and conditions commanders must understand to successfully apply combat power, protect the force, or complete the mission. This includes the air, land, sea, space, and the included enemy and friendly forces, facilities, weather, terrain, the electromagnetic spectrum, and the information environment within the operational areas and areas of interest (see Figure 4-5).

4-78. Battlespace is conceptual—a higher commander does not assign it. Commanders determine their battlespace based on their concept of operations, accomplishing the mission, and protecting the force. Commanders use

their experience, professional knowledge, and understanding of the situation to visualize and change their battlespace as current operations transition to future operations. Battlespace is not synonymous with AO. However, because battlespace is conceptual, Army forces conduct operations only within that portion of it delineated by their AO.

Areas of Influence and Interest

4-79. Battlespace has an associated area of influence and area of interest. An *area of influence* is a geographical area in which a commander can directly influence operations by maneuver or fire support systems normally under the commander's command or control. Areas of influence surround and include the associated AO. The extent of subordinate units' areas of influence normally guides higher commanders in assigning subordinate AOs. An AO should not be substantially larger than the unit's area of influence. An *area of interest* is that area of concern to the commander, including the area of influence and areas adjacent to it. It extends into enemy territory, to the objectives of current or planned operations. This area also includes areas occupied by enemy forces that could jeopardize the accomplishment of the mission. Areas of interest serve to focus intelligence development and IO directed at factors outside the AO that may affect the operation.

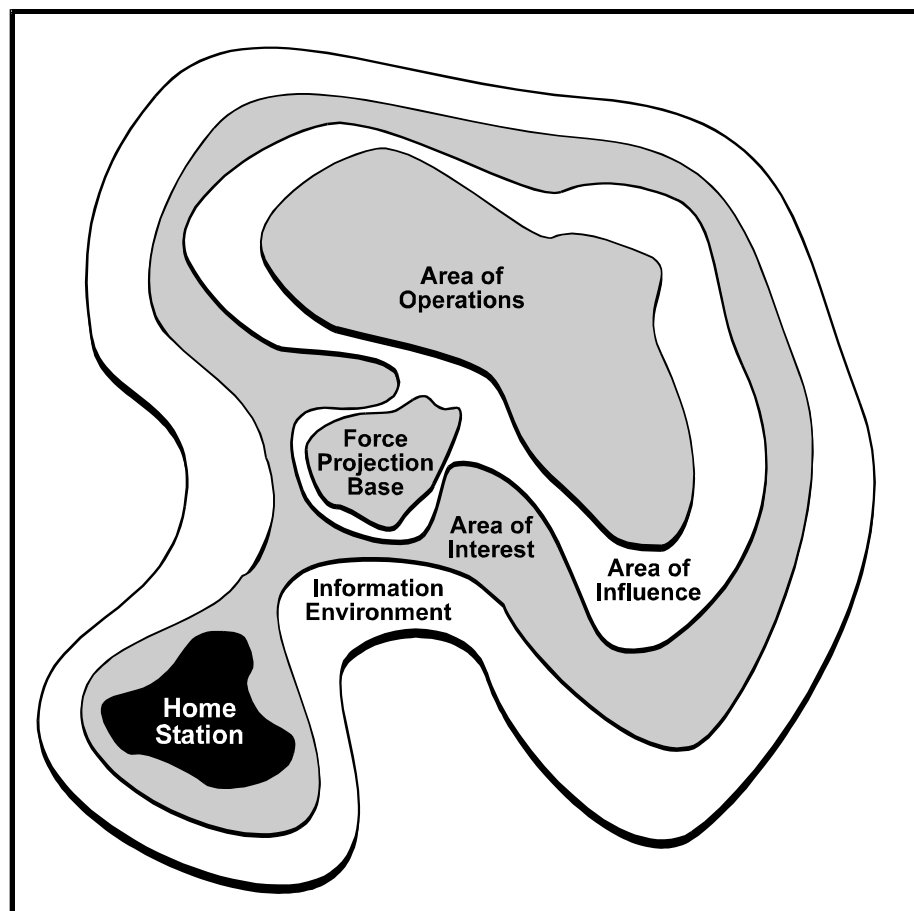

Figure 4-5. Battlespace Components

The Information Environment

4-80. A commander's battlespace includes that part of the information environment that encompasses information activity affecting the operation. The information environment contains information activities that collect, process, and disseminate information to national and international audiences but are beyond direct military influence. It includes space-based systems that provide data and information to Army forces. To envision that part of the information environment that is within their battlespace, commanders determine the information activities that affect their operation and the capabilities of their own and opposing C2 and information systems.

Force Projection Bases

4-81. Army forces may deploy from home station directly to the AO or may move to the AO through force projection bases. Intermediate staging bases and power projection platforms are force projection bases. Force projection bases influence operations in a fashion similar to home stations. Sometimes one part of the deploying force will be at the force projection base while another operates in the AO. The deployed force may receive combat support (CS) and CSS from the force projection base for some or all of the operation.

Home Station

4-82. Home stations are the permanent locations of active component (AC) units and reserve component (RC) units (for example, the location of an armory or reserve center). Because the Army is a power projection force, its AC units deploy from and return to home stations. RC forces normally mobilize and deploy from installations that serve as power projection platforms (see FM 3-100.22). Although home stations and power projection platforms lie outside the AO, the commander's battlespace includes them. Home stations provide support to deployed forces until they return. The ability to receive CS, CSS, and C2 support from home station assets reduces the size of the deployed force. To a significant degree, events occurring at home station affect the morale and performance of deployed forces. Thus, the commander's battlespace encompasses all home station functions, including family readiness programs.

BATTLEFIELD ORGANIZATION

4-83. As part of the military decision making process, commanders visualize their battlespace and determine how to arrange their forces. **The *battlefield organization* is the allocation of forces in the AO by purpose. It consists of three all-encompassing categories of operations: decisive, shaping, and sustaining.** Purpose unifies all elements of the battlefield organization by providing the common focus for all actions. Commanders organize forces according to purpose by determining whether each unit's operation will be decisive, shaping, or sustaining. These decisions form the basis of the concept of operations. When circumstances require a spatial reference, commanders describe the AO in terms of deep, close, and rear areas. These spatial categories are especially useful in operations that are generally contiguous and linear and feature a clearly defined enemy force.

Decisive Operations

4-84. **Decisive operations** are those that directly accomplish the task assigned by the higher headquarters. Decisive operations conclusively determine the outcome of major operations, battles, and engagements. There is only one decisive operation for any major operation, battle, or engagement for any given echelon. The decisive operation may include multiple actions conducted simultaneously throughout the AO. Commanders weight the decisive operation by economizing on combat power allocated to shaping operations.

4-85. In the offense and defense, decisive operations normally focus on maneuver. For example, Third Army's decisive operation in the Gulf War sent VII Corps against the Iraqi Republican Guard after a major shaping operation by the USCENTCOM air component. Conversely, CSS units may conduct the decisive operation during mobilization and deployment or in support operations, particularly if the mission is humanitarian.

Shaping Operations

4-86. **Shaping operations at any echelon create and preserve conditions for the success of the decisive operation.** Shaping operations include lethal and nonlethal activities conducted throughout the AO. They support the decisive operation by affecting enemy capabilities and forces, or by influencing enemy decisions. Shaping operations use all elements of combat power to neutralize or reduce enemy capabilities. They may occur before, concurrently with, or after the start of the decisive operation. They may involve any combination of forces and occur throughout the AO.

Sample Shaping Operations

- Economy of force actions
- Security Operations
- Actions designed to limit enemy freedom of action
- Actions to deny the enemy the ability to concentrate
- Attacks designed to fix enemy forces
- Destruction of enemy capabilities
- Information operations (including military deception)
- Covering force actions

4-87. Some shaping operations, especially those that occur simultaneously with the decisive operation, are economy of force actions. If the force available does not permit simultaneous decisive and shaping operations, the commander sequences shaping operations around the decisive operation. Regardless of the type of operation, commanders may designate a successful shaping operation as the decisive operation. In that case, commanders weight the new decisive operation with combat power from other shaping operations. The concept of operations clearly describes how shaping operations support the decisive operation.

4-88. Security operations are important shaping operations. They enable the decisive operation of the next higher headquarters and provide time and space for friendly forces to react to enemy activities. They also blind enemy

attempts to gain information on friendly forces and protect friendly forces from enemy observation and fires.

4-89. A reserve is a portion of a body of troops, kept to the rear or withheld from action at the beginning of an engagement and available for a decisive movement. Until committed, reserves shape through their placement within the AO. For example, the placement or movement of the reserve helps deceive the enemy as to the decisive operation and influences when the enemy commits forces. When committed, reserves either become or reinforce the decisive operation. Reserves prepare to seize and retain the initiative as a situation develops. Commanders use them to influence circumstances or exploit opportunities. When commanders anticipate uncertainty, they hold a greater portion of the force in reserve. Reserves reposition as necessary to ensure their protection and prompt availability.

Sustaining Operations

4-90. The purpose of sustaining operations is to generate and maintain combat power. ***Sustaining operations* are operations at any echelon that enable shaping and decisive operations by providing combat service support, rear area and base security, movement control, terrain management, and infrastructure development.** Sustaining operations include the following elements:

- **Combat service support** encompasses activities at all levels of war that generate and sustain combat power. It provides the essential capabilities and performs the functions, activities, and tasks necessary to sustain all forces in theater.
- **Rear area and base security** includes measures taken by military units, activities, and installations to protect themselves from acts designed to impair their effectiveness. It has four components: intelligence, base and base cluster self-defense, response force operations, and combined arms tactical combat force (TCF) operations (see FM 3-100.40).
- **Movement control** includes planning, routing, scheduling, and controlling personnel and materiel movements into, within, and out of an AO. Maintaining movement control, keeping LOCs open, managing reception and transshipment points, and obtaining host nation support are critical to movement control.
- **Terrain management** includes allocating terrain, designating assembly areas, and specifying locations for units and activities. It includes grouping units into bases and designating base clusters as necessary.
- **Infrastructure development** applies to all fixed and permanent installations, fabrications, or facilities that support and control military forces. Infrastructure development focuses on facility security modifications and includes area damage control and repairs.

A tactical combat force is a combat unit, with appropriate combat support and combat service support assets, that is assigned the mission of defeating level III threats.

4-91. While sustaining operations are inseparable from decisive and shaping operations, they are not usually decisive themselves. However, in some support operations, CSS forces may be the decisive element of the Army force. Sustaining operations occur throughout the AO, not just within a rear area. Failure to sustain normally results in mission failure. Sustaining operations determine how fast Army forces reconstitute and how far Army forces can exploit success.

4-92. At the operational level, sustaining operations focus on preparing for the next phase of the campaign or major operation. At the tactical level, sustaining operations underwrite the tempo of the overall operation; they assure the ability to take immediate advantage of any opportunity.

Main Effort

4-93. Within the battlefield organization of decisive, shaping, and sustaining operations, commanders designate and shift the main effort. **The main effort is the activity, unit, or area that commanders determine constitutes the most important task at that time.** Commanders weight the main effort with resources and priorities and shift it as circumstances and intent demand.

4-94. The main effort and the decisive operation are not always identical. Commanders anticipate shifts of main effort throughout an operation and include them in the plan. In contrast, changing the decisive operation requires execution of a branch, sequel, or new plan. A shaping operation may be the main effort before execution of the decisive operation. However, the decisive operation becomes the main effort upon execution.

Close, Deep, and Rear Areas

4-95. Despite the increasing nonlinear nature of operations, there may be situations where commanders describe decisive, shaping, and sustaining operations in spatial terms (see Figure 4-6, page 4-26). Typically, linear operations involve conventional combat and concentrated maneuver forces. Ground forces share boundaries and orient against a similarly organized enemy force. Terrain or friendly forces secure flanks and protect CSS operations. In some multinational operations, the capabilities and doctrine of partners may dictate spatial organization of the AO. In such situations, commanders designate close, deep, and rear areas.

4-96. **Close Areas.** When designated, **the close area is where forces are in immediate contact with the enemy and the fighting between the committed forces and readily available tactical reserves of both combatants is occurring, or where commanders envision close combat taking place. Typically, the close area assigned to a maneuver force extends from its subordinates' rear boundaries to its own forward boundary.** Commanders plan to conduct decisive operations through maneuver and fires in the close area and position most of the maneuver force within it.

4-97. The activities of forces directly supporting fighting elements also occur in the close area. Examples of these activities are field artillery fires and combat health support. Within the close area, depending on echelon, one unit

may conduct the decisive operation while others conduct shaping operations. Commanders of forces engaged in the close area may designate subordinate deep, close, and rear areas.

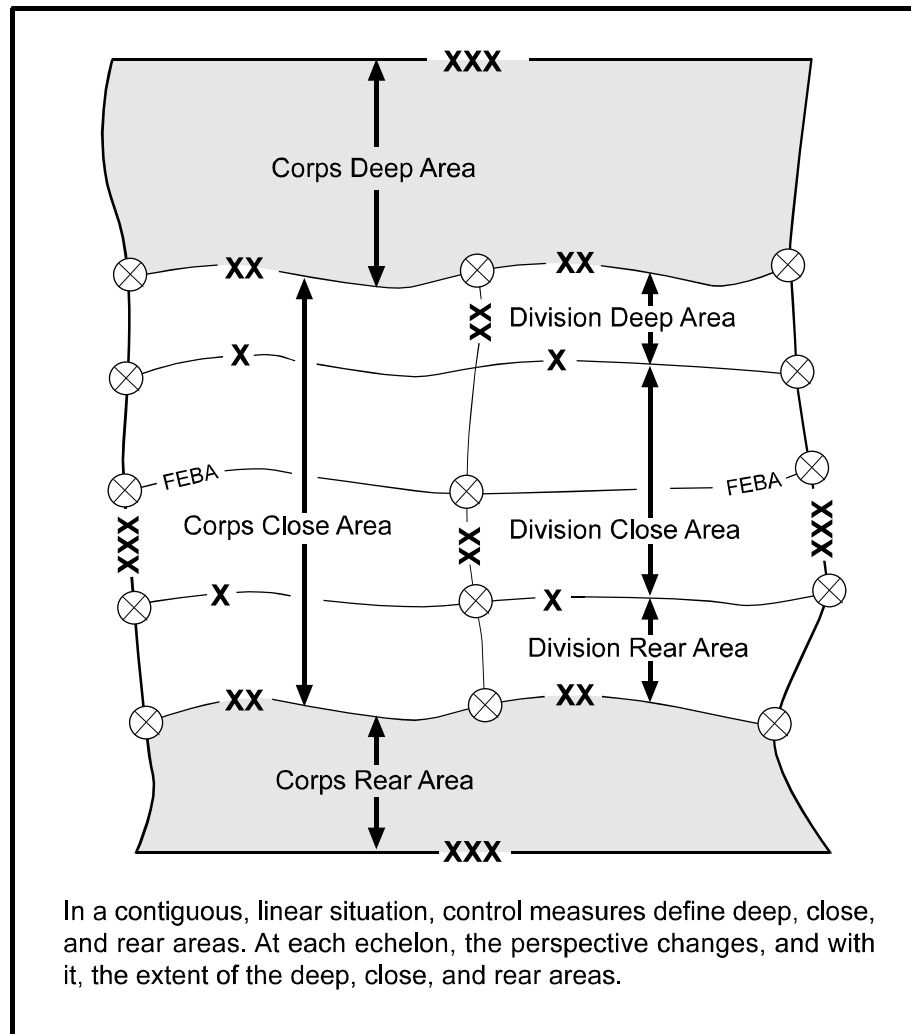

Figure 4-6. Close, Deep, and Rear Areas

4-98. **Deep Areas.** When designated, the *deep area* is an area forward of the close area that commanders use to shape enemy forces before they are encountered or engaged in the close area. Typically, the deep area extends from the forward boundary of subordinate units to the forward boundary of the controlling echelon. Thus, the deep area relates to the close area not only in terms of geography but also in terms of purpose and time. The extent of the deep area depends on the force's area of influence—how far out it can acquire information and strike targets. Commanders may place forces in the deep area to conduct shaping operations. Some of these operations may involve close combat. However, most maneuver forces stay in the close area.

4-99. **Rear Areas.** When designated, **the rear area for any command extends from its rear boundary forward to the rear boundary of the next lower level of command. This area is provided primarily for the performance of support functions and is where the majority of the echelon's sustaining operations occur.** Operations in rear areas assure freedom of action and continuity of operations, sustainment, and C2. Their focus on providing CS and CSS leaves units in the rear area vulnerable to attack. Commanders may designate combat forces to protect forces and facilities in the rear area. In some cases, commanders may designate a noncontiguous rear area due to geography or other circumstances. In this case, the rear area force protection challenge increases due to physical separation of forces in the rear area from combat units that would otherwise occupy a contiguous close area.

ARMY CAPABILITIES

4-100. Commanders combine AC and RC Army forces—consisting of different types of units with varying degrees of modernization—with multinational forces and civilian agencies to achieve effective and efficient unified action. A broad range of organizations makes up the institutional Army that supports the field Army. Institutional Army organizations design, man, train, and equip the force. The institutional Army assists effectively integrating Army capabilities. It does this through leadership and guidance regarding force structure, doctrine, modernization, and budget (see FM 3-100.11).

TASK ORGANIZATION

4-101. The Army supports JFCs by providing tailored force packages to accomplish joint missions and dominate enemies and situations on land. Trained and equipped AC and RC units comprise these force packages. Within these force packages, Army commanders organize groups of units for specific missions. They reorganize for subsequent missions when necessary. **This process of allocating available assets to subordinate commanders and establishing their command and support relationships is called *task organizing*. A temporary grouping of forces designed to accomplish a particular mission is a *task organization*.** The ability of Army forces to tailor (select forces based upon a mission) and task organize (temporarily organize units to accomplish a tactical mission) gives them extraordinary agility. It allows operational- and tactical-level commanders to organize their units to make best use available resources. The ability to task organize means Army forces can shift rapidly among offensive, defensive, stability, and support operations.

COMBINED ARMS

4-102. The fundamental basis for the organization and operations of Army forces is combined arms. ***Combined arms is the synchronized or simultaneous application of several arms—such as infantry, armor, field artillery, engineers, air defense, and aviation—to achieve an effect on the enemy that is greater than if each arm was used against the enemy separately or in sequence.*** The ultimate goal of Army organization for operations remains success in joint and combined arms warfare. Its com-

bined arms capability allows commanders to form Army combat, CS, and CSS forces into cohesive teams focused on common goals.

IF RELATIONSHIP IS:		INHERENT RESPONSIBILITIES ARE:							
		Has Command Relationship with:	May Be Task Organized by:	Receives CSS from:	Assigned Position or AO By:	Provides Liaison To:	Establishes/ Maintains Communications with:	Has Priorities Established by:	Gaining Unit Can Impose Further Command or Support Relationship of:
COMMAND	Attached	Gaining unit	Gaining unit	Gaining unit	Gaining unit	As required by gaining unit	Unit to which attached	Gaining unit	Attached; OPCON; TACON; GS; GSR; R; DS
	OPCON	Gaining unit	Parent unit and gaining unit; gaining unit may pass OPCON to lower HQ. Note 1	Parent unit	Gaining unit	As required by gaining unit	As required by gaining unit and parent unit	Gaining unit	OPCON; TACON; GS; GSR; R; DS
	TACON	Gaining unit	Parent unit	Parent unit	Gaining unit	As required by gaining unit	As required by gaining unit and parent unit	Gaining unit	GS; GSR; R; DS
	Assigned	Parent unit	Parent unit	Parent unit	Gaining unit	As required by parent unit	As required by parent unit	Parent unit	Not Applicable
SUPPORT	Direct Support (DS)	Parent unit	Parent unit	Parent unit	Supported unit	Supported unit	Parent unit; Supported unit	Supported unit	Note 2
	Reinforcing (R)	Parent unit	Parent unit	Parent unit	Reinforced unit	Reinforced unit	Parent unit; reinforced unit	Reinforced unit; then parent unit	Not Applicable
	General Support Reinforcing (GSR)	Parent unit	Parent unit	Parent unit	Parent unit	Reinforced unit and as required by parent unit	Reinforced unit and as required by parent unit	Parent unit; then reinforced unit	Not Applicable
	General Support (GS)	Parent unit	Parent unit	Parent unit	Parent unit	As required by parent unit	As required by parent unit	Parent unit	Not Applicable

NOTE 1. In NATO, the gaining unit may not task organize a multinational unit (see TACON).

NOTE 2. Commanders of units in DS may further assign support relationships between their subordinate units and elements of the supported unit after coordination with the supported commander.

Figure 4-7. Army Command and Support Relationships and Inherent Responsibilities

ARMY COMMAND AND SUPPORT RELATIONSHIPS

4-103. Commanders build combined arms organizations using command and support relationships (see Figure 4-7). Command relationships define command responsibility and authority. Support relationships define the purpose, scope, and effect desired when one capability supports another.

COMPLEMENTARY AND REINFORCING EFFECTS

4-104. The services and the various arms within Army forces complement each other by posing a dilemma for the enemy. As the enemy evades the effects of one type of action, he exposes himself to destruction by another. This leads to enemy paralysis, destruction, or surrender. A tactical example of complementary effects is suppressing a defender with indirect fires while maneuvering to envelop and destroy him. If the enemy attempts to move to meet the threat, he risks destruction from the fires. If he remains in place to survive the fires, he risks being encircled and trapped.

4-105. *Complementary* capabilities protect the weaknesses of one system or organization with the capabilities of another (see Figure 4-8). For example, tanks combine protection, firepower, and mobility. However, they are vulnerable to mines, antiarmor missiles, concealed infantry, and restricted avenues of approach. They are particularly vulnerable in urban areas and dense vegetation. Therefore, commanders combine tanks, infantry, and engineers into combined arms teams and task forces. The infantry maneuvers on terrain where armor cannot and eliminates concealed threats to the tanks. The engineers clear obstacles, restoring the mobility of the armor. Unhindered by small arms fire, the armor maneuvers to deliver devastating firepower to

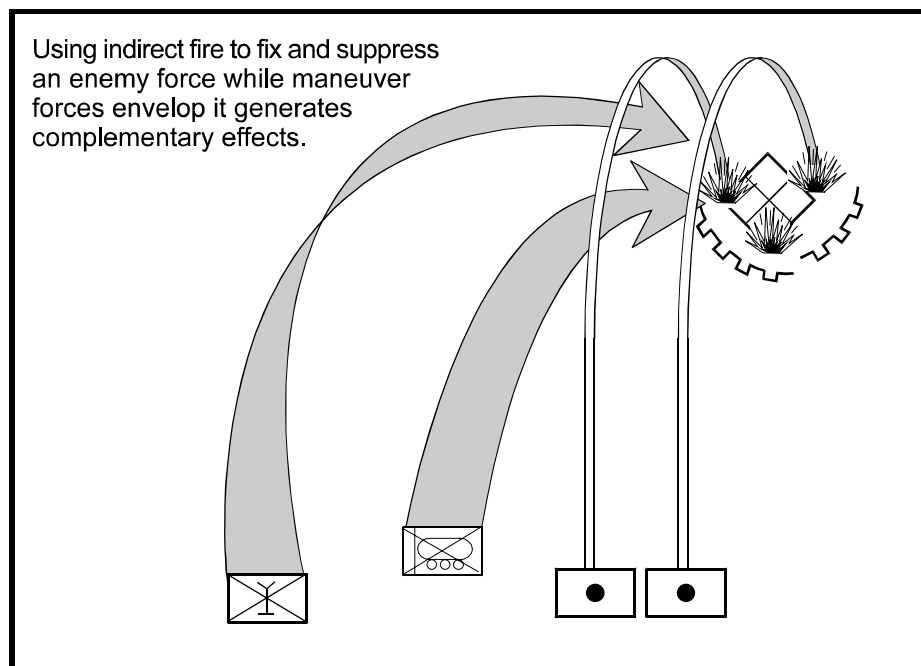

Figure 4-8. Complementary Effects

support the infantry and engineers. CSS units support, providing the capabilities that the mix of systems requires.

4-106. At the operational level, the capabilities of the services complement each other. This situation provides JFCs with a wide range of options and confronts enemies with difficult dilemmas. Army, Navy, Marine, and Air Force aircraft engage targets that degrade enemy capabilities. Space, airborne, and land-based sensors monitor enemy reactions. Pilots and aviators use this information to refine and sharpen strikes. Ground forces maneuver, seize terrain, and destroy enemy forces. If the enemy attempts to meet the ground maneuver, he leaves his protected areas and exposes himself to the full weight of air power and long-range missiles. He is then even more vulnerable to the effects of maneuver. If the enemy attempts missile strikes on US air bases and lodgments, theater missile defenses, supported by space systems, intercept the weapons. As US ground forces maneuver, they overrun enemy air defenses, air bases, launch areas, command posts, and CSS units, eliminating both tactical and operational threats and rendering the enemy's situation hopeless.

4-107. Army forces and those of the other services *reinforce* each other when they combine the effects of similar capabilities (see Figure 4-9). Commanders reinforce to achieve focused, overwhelming effects at a single point. When massed, different types of field artillery systems, such as howitzers and missiles, reinforce each other. Aerial fires have similar effects and can reinforce indirect fires. In a similar manner, commanders reinforce maneuver elements to guarantee superiority at the decisive time and place.

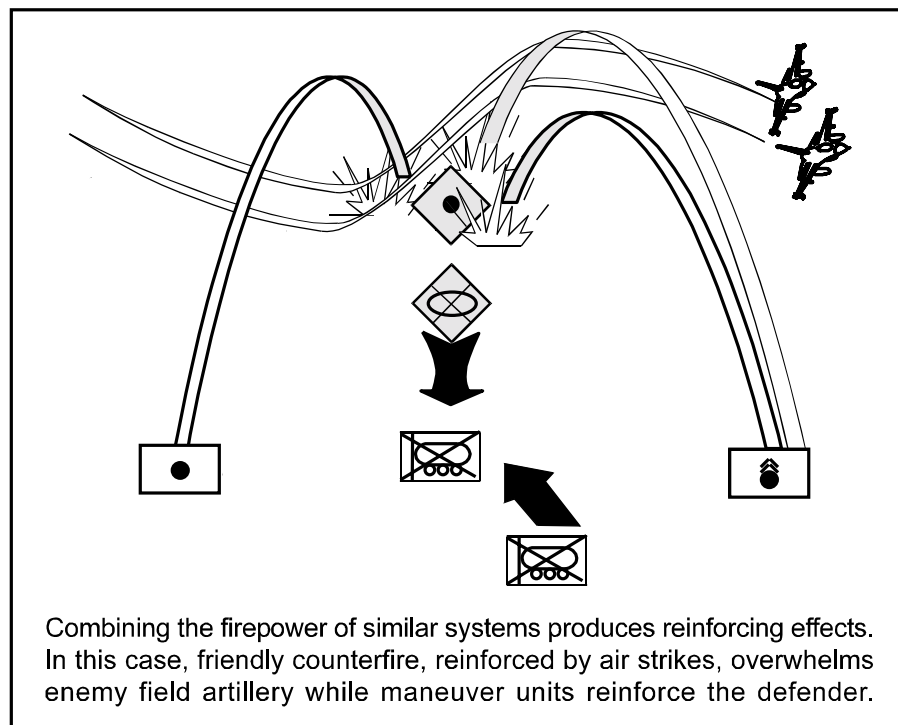

Figure 4-9. Reinforcing Effects

4-108. Achieving complementary and reinforcing effects requires synchronization, initiative, and versatility. Synchronized action is the basis for complementary and reinforcing effects. Commanders focus systems in space and time to generate synergy that increases effects. The initiative of leaders combines units and systems in the fluid circumstances of action, often in the absence of orders. Confronted with a constantly changing situation, leaders develop new combinations of systems and pose new dilemmas for the adversary. Properly combined, these effects produce asymmetries that the joint force uses to achieve theater objectives.

ASYMMETRY

4-109. Asymmetry concerns dissimilarities in organization, equipment, doctrine, capabilities, and values between other armed forces (formally organized or not) and US forces. JFCs arrange symmetrical and asymmetrical actions to take advantage of friendly strengths and enemy vulnerabilities, and to preserve freedom of action. Engagements are symmetric if forces, technologies, and weapons are similar; they are asymmetric if forces, technologies, and weapons are different, or if a resort to terrorism and rejection of more conventional rules of engagement are the norm. In one sense, there are always asymmetries between forces: differing circumstances lead to differing military structures. Asymmetry becomes very significant, perhaps decisive, when the degree of dissimilarity creates exploitable advantages. Asymmetric engagements can be extremely lethal, especially if the target is not ready to defend itself against the asymmetric threat. Asymmetry tends to decay over time as adversaries adapt to dissimilarities exposed in action. In a larger sense, asymmetric warfare seeks to avoid enemy strengths and concentrate comparative advantages against relative weaknesses. The following tactical and operational examples illustrate the dynamic nature of asymmetry.

4-110. Third Army forces in the Gulf War were equipped with second-generation thermal sights. Iraqi units depended upon older, far less capable active infrared and light amplification systems. In engagement after engagement, US, British, and French armor destroyed Iraqi units, who could only return ineffective fire. At the system level, the advanced armor on the US and British tanks resisted the occasional hit from Iraqi fire, while friendly rounds immediately destroyed their targets. At tactical levels, Army forces exploited asymmetry in terms of equipment and organization.

4-111. In 1999, Serbian forces in Kosovo faced unrelenting aerial bombardment by North Atlantic Treaty Organization (NATO) air forces. As the air operations intensified, NATO refined its strike techniques while the Serbs applied techniques learned by the Iraqis during the Gulf War. Over time, the Serbs became very proficient at using decoys and concealment. Although they were unable to prevent losses, Serbian units protected most of their ground combat systems from this asymmetric attack. Thus, the asymmetric advantage conferred by advanced air power over ground elements decayed over time.

4-112. At the operational level in the Gulf War, USCENTCOM exploited the inherent flexibility of sea power and amphibious assault to threaten the Iraqi forces in Kuwait with a major strike from the Persian Gulf. Lacking a navy,

the only possible operational response by the Iraqi high command was to shift six divisions to coastal defense. The coalition ground offensive enveloped and destroyed these Iraqi forces, which were fixed by the threat of amphibious assault.

4-113. The likelihood of asymmetric attack increases with the continued conventional dominance of US forces at sea, on land, in the air, and in space. Such attacks may only disrupt tactical activities briefly; however, the operational and strategic consequences, particularly in stability operations and support operations, may be far-reaching. In Beirut, Lebanon, in 1983, and again at Khobar Towers, Saudi Arabia, in 1996, massive truck bombs destroyed portions of US military compounds, with heavy loss of life. Both attacks demonstrated asymmetry in terms of equipment and values. In addition, each was a political act of terrorism taken against a military objective. The risks of asymmetry multiply with the threat of WMD.

4-114. Asymmetric attacks pose dilemmas to both friendly and enemy forces. Countering asymmetric attacks requires the disadvantaged side to alter rules of engagement, organization, doctrine, training, or equipment. The higher the echelon, the longer it takes to remedy an enemy asymmetric advantage. To reduce the vulnerability to asymmetric attacks and to minimize their effects, Army organizations, training, and equipment emphasize flexible employment in diverse situations. Protective measures, such as physical security and OPSEC, lessen the effects of asymmetry. A credible NBC defense capability at the tactical level deters the use of WMD. Commanders must anticipate asymmetries and take preventive measures that reduce adversary advantages. Commanders identify and exploit friendly capabilities that pose asymmetric challenges to the enemy force, even as Army forces act to counter hostile asymmetric threats.

Chapter 5

Battle Command

...[It is] essential that all leaders—from subaltern to commanding general—familiarize themselves with the art of clear, logical thinking. It is more valuable to be able to analyze one battle situation correctly, recognize its decisive elements and devise a simple, workable solution for it, than to memorize all the erudition ever written of war.

Infantry in Battle, 1939

5-1. Battle command applies the leadership element of combat power. It is principally an art that employs skills developed by professional study, constant practice, and considered judgment. Commanders, assisted by the staff, visualize the operation, describe it in terms of intent and guidance, and direct the actions of subordinates within their intent. Commanders direct operations in terms of the battlefield operating systems (BOS). They directly influence operations by personal presence, supported by their command and control (C2) system.

CONTENTS	
The Art of Command	5-1
Visualize, Describe, Direct	5-2
Visualize.....	5-3
The Factors of METT-TC	5-3
The Elements of Operational Design... ..	5-6
Input From Other Commanders and Staff	5-12
The Commander’s Experience and Judgment.....	5-13
Describe	5-13
Commander’s Intent	5-14
Planning Guidance	5-15
Direct.....	5-15
Intelligence	5-16
Maneuver	5-16
Fire Support.....	5-16
Air Defense	5-16
Mobility/Counter mobility/ Survivability.....	5-16
Combat Service Support.....	5-17
Command and Control.....	5-17
Personal Impact of the Commander	5-18

THE ART OF COMMAND

5-2. Command is the authority a commander in military service lawfully exercises over subordinates by virtue of rank and assignment. Leaders possessing command authority strive to use it with firmness, care, and skill. Command remains a very personal function. As such, it is more an art than a science, although it exhibits characteristics of both.

5-3. **Battle command is the exercise of command in operations against a hostile, thinking enemy.** Skilled judgment gained from practice, reflection, study, experience, and intuition often guides it. The art of command lies in conscious and skillful exercise of command authority through

visualization, decision making, and leadership. Using judgment acquired from experience, training, study, and creative thinking, commanders visualize the situation and make decisions. In unclear situations, informed intuition may help commanders make effective decisions by bridging gaps in information. Through the art of command, commanders apply their values, attributes, skills, and actions to lead and motivate their soldiers and units. Well-led units succeed in training and accomplish their missions. As the senior leaders of organizations, commanders apply the leadership element of combat power. Subordinate commanders and small unit leaders reinforce it.

5-4. Effective battle command demands decisions that are both timely and more effective than those of the enemy. Success often depends on superior information that enables superior decisions. Effective decision making combines judgment with information as an element of combat power: it requires knowing if to decide, when to decide, and what to decide. It requires commanders to judge information quality. It also requires identifying important information and focusing subordinates and the staff on it. These are tactical, operational, and strategic judgments. Commanders anticipate and understand the activities that follow decisions, knowing that once executed, some commitments are irretrievable.

5-5. Battle command puts a premium on leader skills and actions that contribute to effective decisions. The volume of available information challenges all leaders. They assimilate enormous amounts of information as they visualize the operation, describe their intent, and direct their subordinates' actions. Visualizing the operation is continuous. It requires commanders to understand the current situation, broadly define the future situation, assess the difference between the two, and envision major actions that link them. Commanders accept calculated risks to seize and retain the initiative. They assess the tradeoff between risks and opportunities and apply it to their vision.

5-6. To translate the commander's vision into action, the staff and subordinates must understand it. Commanders describe their vision in succinct planning guidance and the commander's intent, providing enough detail to focus planning and preparation. To command is to direct. Commanders direct the outcome of major operations, battles, and engagements by—

- Assigning missions.
- Prioritizing and allocating resources.
- Assessing and taking risks.
- Deciding when and how to make adjustments.
- Committing reserves.
- Seeing, hearing, and understanding the needs of subordinates and superiors.
- Guiding and motivating the organization to accomplish the mission.

VISUALIZE, DESCRIBE, DIRECT

5-7. Visualizing, describing, and directing are aspects of leadership common to all commanders. Technology, the fluid nature of operations, and the volume of information increase the importance of commanders being able to visualize and describe operations. Commanders' perspective and the things

they emphasize change with echelon. Operational art differs from tactics principally in the scope and scale of what commanders visualize, describe, and direct. Operational commanders identify the time, space, resources, purpose, and action of land operations and relate them to the joint force commander's (JFC's) operational design. In contrast, tactical commanders begin with an area of operations (AO) designated, objectives identified, the purpose defined, forces assigned, sustainment allocated, and time available specified.

5-8. While JFCs and component commanders exercise leadership primarily through subordinates, small unit commanders command face to face. Operational success depends on the ability of operational commanders to visualize and describe complex land operations; tactical success depends on the ability of small unit commanders to motivate and direct soldiers.

5-9. Commanders use the factors of METT-TC to assess the situation. Staff estimates and collaborative information sharing among commanders refine and deepen their situational understanding. Commanders then visualize the operation, describe it within their intent, and direct their subordinates toward mission accomplishment. Depending on echelon, commanders examine the elements of operational design and determine factors that will shape the operation. Commanders direct operations and synchronize the BOS through plans and orders. They personally apply the leadership element of combat power through their presence and priorities (see Figure 5-1, page 5-4).

VISUALIZE

5-10. Upon receipt of a mission, commanders consider their battlespace and conduct a mission analysis that results in their initial vision, which they continually confirm or modify. Commanders use the factors of METT-TC, elements of operational design, staff estimates, input from other commanders, and their experience and judgment to develop their vision.

5-11. To visualize the desired outcome, commanders must clearly understand the situation in the battlespace: What is the mission? What are the enemy's capabilities and likely actions? What are the characteristics of the AO? Do weather and terrain favor friendly or enemy actions? How much time is available? What combat service support (CSS) factors are most important? What role do civil considerations play? This framing of the battlespace takes place during mission analysis (see FM 5-0). Additionally, commanders draw on the principles of war, tenets of operations, and their experience.

The Factors of METT-TC

5-12. METT-TC refers to factors that are fundamental to assessing and visualizing: Mission, Enemy, Terrain and weather, Troops and support available, Time available, and Civil considerations. The first five factors are not new. However, the nature of full spectrum operations requires commanders to assess the impact of nonmilitary factors on operations. Because of this added complexity, *civil considerations* has been added to the familiar METT-T to form METT-TC. All commanders use METT-TC to start their visualization. Staff estimates may address individual elements of, and add to, the commander's visualization.

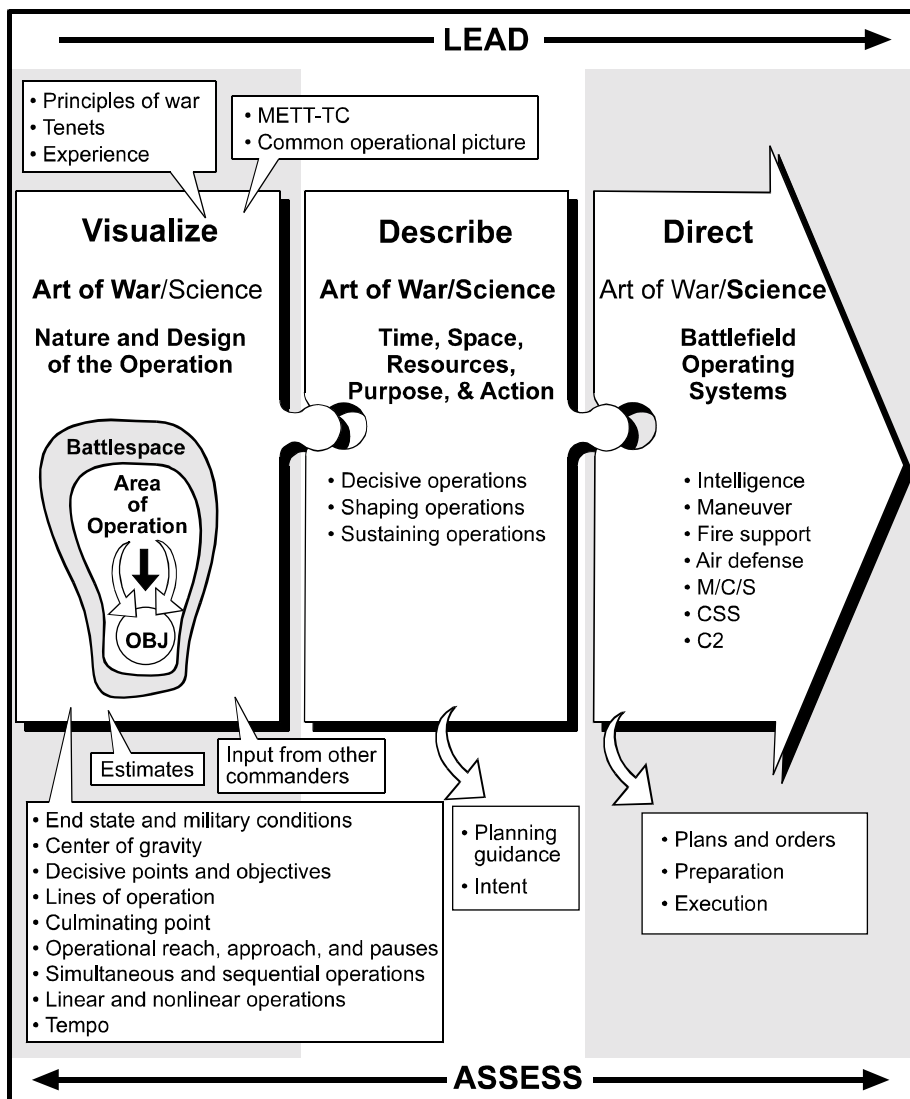

Figure 5-1. Visualize, Describe, Direct

5-13. **Mission.** Commanders determine the mission through analysis of the tasks assigned. The results of that analysis yield the essential tasks that, together with the purpose of the operation, clearly indicate the action required. The mission includes what tasks must be accomplished; who is to do them; and when, where, and why the tasks are to be done.

5-14. **Enemy.** The analysis of the enemy includes current information about his strength, location, activity, and capabilities. Commanders and staffs also assess the most likely enemy courses of action. In stability operations and support operations, the analysis includes adversaries, potentially hostile parties, and other threats to success. Threats may include the spread of infectious disease, regional instabilities, or misinformation. Commanders consider asymmetric as well as conventional threats.

5-15. **Terrain and Weather.** Analysis of terrain and weather helps commanders determine observation and fields of fire, avenues of approach, key terrain, obstacles and movement, and cover and concealment (OAKOC [see FM 6-0]). Terrain includes manmade features such as cities, airfields, bridges, railroads, and ports. Weather and terrain also have pronounced effects on ground maneuver, precision munitions, air support, and CSS operations. The nature of operations extends the analysis of the natural environment (weather and terrain) into the context of the physical environment of a contaminated battlefield. To find tactical advantages, commanders and staffs analyze and compare the limitations of the environment on friendly, enemy, and neutral forces.

5-16. **Troops and Support Available.** Commanders assess the quantity, training level, and psychological state of friendly forces. The analysis includes the availability of critical systems and joint support. Commanders examine combat, combat support (CS), and CSS assets. These assets include contractors (see FM 3-100.21).

5-17. **Time Available.** Commanders assess the time available for planning, preparing, and executing the mission. They consider how friendly and enemy or adversary forces will use the time and the possible results.

You can ask me for anything you like, except time...

Napoleon

Proper use of the time available can fundamentally alter the situation. Time available is normally explicitly defined in terms of the tasks assigned to the unit and implicitly bounded by enemy or adversary capabilities.

5-18. **Civil Considerations.** Civil considerations relate to civilian populations, culture, organizations, and leaders within the AO. Commanders consider the natural environment, to include cultural sites, in all operations directly or indirectly affecting civilian populations. Commanders include civilian political, economic, and information matters as well as more immediate civilian activities and attitudes.

5-19. At the operational level, civil considerations include the interaction between military operations and the other instruments of national power. Civil considerations at the tactical level generally focus on the immediate impact of civilians on the current operation; however, they also consider larger, long-term diplomatic, economic, and informational issues. Civil considerations can tax the resources of tactical commanders while shaping force activities. Civil considerations define missions to support civil authorities.

5-20. Political boundaries of nations, provinces, and towns are important civil considerations. Conflict often develops across boundaries, and boundaries may impose limits on friendly action. Boundaries, whether official or not, determine which civilian leaders and institutions can influence a situation. These considerations can be important at all levels.

5-21. Media presence guarantees that a global audience views US military activities in near real-time. Commanders factor public opinion into their vision of the battlespace. The activities of the force—including individual soldiers—can have far reaching effects on domestic and international opinion. The media also affect activities and opinions within the AO and often prove a valuable information resource.

5-22. The local population and displaced persons influence commanders' decisions. Their presence and the need to address their control, protection, and welfare affect the choice of courses of action and the allocation of resources. In stability operations and support operations, these people are a central feature of AOs.

The Elements of Operational Design

5-23. A major operation begins with a design—an idea that guides the conduct (planning, preparation, execution, and assessment) of the operation. The operational design provides a conceptual linkage of ends, ways, and means. The elements of operational design are tools to aid designing major operations. They help commanders visualize the operation and shape their intent.

Elements of Operational Design

- End state and military conditions
- Center of gravity
- Decisive points and objectives
- Lines of operation
- Culminating point
- Operational reach, approach, and pauses
- Simultaneous and sequential operations
- Linear and nonlinear operations
- Tempo

5-24. The elements of operational design are most useful in visualizing major operations. They help clarify and refine the vision of operational-level commanders by providing a framework to describe operations in terms of task and purpose. They help commanders understand the complex combinations of combat power involved. However, their usefulness and applicability diminishes at each lower echelon. For example, senior tactical commanders must translate the operational commander's operational reach and culminating point into a limit of advance for ground forces. Decisive points become geographic or force-oriented objectives. Senior tactical commanders normally consider end state, decisive points and objectives, culminating point, simultaneous and sequential operations, linear and nonlinear operations, and tempo. However, their subordinates at the lowest tactical echelons may only consider objectives.

5-1. **End State and Military Conditions.** At the strategic level, the end state is what the National Command Authorities want the situation to be when operations conclude—both those where the military is the primary instrument of national power employed and those where it supports other instruments. It marks the point when military force is no longer the principal strategic means. **At the operational and tactical levels, the end state is the conditions that, when achieved, accomplish the mission. At the operational level, these conditions attain the aims set for the campaign or major operation.**

5-26. JFCs establish the end state for campaigns or joint major operations and set the military conditions necessary to accomplish them. Army operations at the theater level focus on achieving the military conditions on land necessary to achieve the JFC's objectives and end state. In situations where military force is employed with nonmilitary means, commanders designate measures of effectiveness to focus military action. In many operations—particularly short-notice, smaller-scale contingencies—the end state

and supporting military conditions may be poorly defined or entirely absent. In other operations, the end state may be vague or evolving. Therefore, commanders at all levels monitor and assess progress toward the end state. Operational commanders continuously assess the major operation and campaign objectives against measures of effectiveness and the strategic end state.

5-27. **Center of Gravity.** Centers of gravity are those characteristics, capabilities, or localities from which a military force derives its freedom of action, physical strength, or will to fight. Destruction or neutralization of the enemy center of gravity is the most direct path to victory. The enemy will recognize and shield his center of gravity. Therefore, a direct approach may be costly and sometimes futile. Commanders examine many approaches, direct and indirect, to the enemy center of gravity.

5-28. The center of gravity is a vital analytical tool in the design of campaigns and major operations. Once identified, it becomes the focus of the commander's intent and operational design. Senior commanders describe the center of gravity in military terms, such as objectives and missions.

5-29. Commanders not only consider the enemy center of gravity, but also identify and protect their own center of gravity. During the Gulf War, for example, US Central Command identified the coalition itself as the friendly center of gravity. The combatant commander took measures to protect it, including deployment of theater missile defense systems.

5-30. **Decisive Points and Objectives.** A *decisive point* is a geographic place, specific key event, or enabling system that allows commanders to gain a marked advantage over an enemy and greatly influence the outcome of an attack. Decisive points are not centers of gravity; they are keys to attacking or protecting them. Normally, a situation presents more decisive points than the force can control, destroy, or neutralize with available resources. Part of operational art consists of selecting the decisive points that will most quickly and efficiently overcome the enemy center of gravity. Decisive points shape operational design and allow commanders to select objectives that are clearly defined, decisive, and attainable.

5-31. Some decisive points are geographic, for example, a port facility, transportation network or node, or base of operations. Other physical decisive points include elements of an enemy force, such as units, command posts, fire support units capable of delivering weapons of mass destruction (WMD), or important communications sites. Events, such as commitment of the enemy operational reserve, may also be decisive points. Once identified and selected for action, decisive points become objectives.

5-32. Decisive points may have a different character in support missions and stability operations. During hurricane relief efforts in Florida, for example, the Joint Task Force Andrew commander identified the reopening of public schools as a decisive point. This decisive point was physical in nature, but its real value was psychological. Reopening schools signaled to residents that they were on their way to recovery.

5-33. **Lines of Operations.** *Lines of operations* define the directional orientation of the force in time and space in relation to the enemy. They connect the force with its base of operations and its objectives.

In geographic terms, lines of operations connect a series of decisive points that lead to control of the objective or defeat of the enemy force.

5-34. An operation may have single or multiple lines of operation. A single line of operations concentrates forces and simplifies planning. Multiple lines of operations increase flexibility and create several opportunities for success. Multiple lines of operations make it difficult for an enemy to determine the friendly objectives and force him to disperse resources against several possible threats. Each potential option further complicates the enemy's situation and stresses his C2 system. The strategic responsiveness and tactical agility of Army forces create opportunities for simultaneous operations along multiple lines of operations.

5-35. Lines of operations may be either interior or exterior (see Figure 5-2). **A force operates on interior lines when its operations diverge from a central point.** With interior lines, friendly forces are closer to separate enemy forces than the enemy forces are to each other. Interior lines allow a weaker force to mass combat power against a portion of the enemy force by shifting resources more rapidly than the enemy. **A force operates on exterior lines when its operations converge on the enemy.** Operations on exterior lines offer the opportunity to encircle and annihilate a weaker or less mobile enemy; however, they require stronger or more mobile forces.

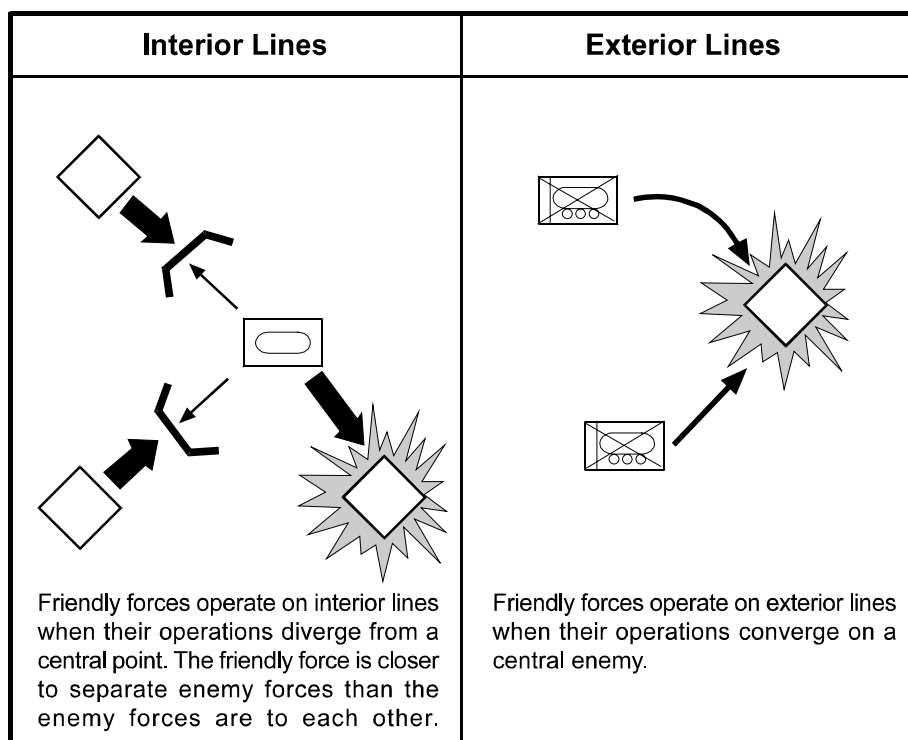

Figure 5-2. Interior and Exterior Lines of Operations

5-36. The relevance of interior and exterior lines depends on the relationship of time and distance between the opposing forces. An enemy force may have interior lines with respect to the friendly force; however, that advantage

disappears if the friendly force is more agile and operates at a higher tempo. Conversely, if a smaller friendly force maneuvers to a position between larger but less agile enemy forces, the friendly force may defeat them in detail before they can react effectively.

5-37. When positional reference to an enemy or adversary has little relevance, commanders may visualize the operation along *logical lines* (see Figure 5-3). This situation is common in stability operations and support operations. Commanders link multiple objectives and actions with the logic of purpose—cause and effect. In a linkage between objectives and forces, only the logical linkage of lines of operations may be evident. Multiple and complementary lines of operations work through a series of objectives. Commanders synchronize activities along multiple lines of operation to achieve the desired end state. Logical lines of operations also help commanders visualize how military means can support nonmilitary instruments of national power.

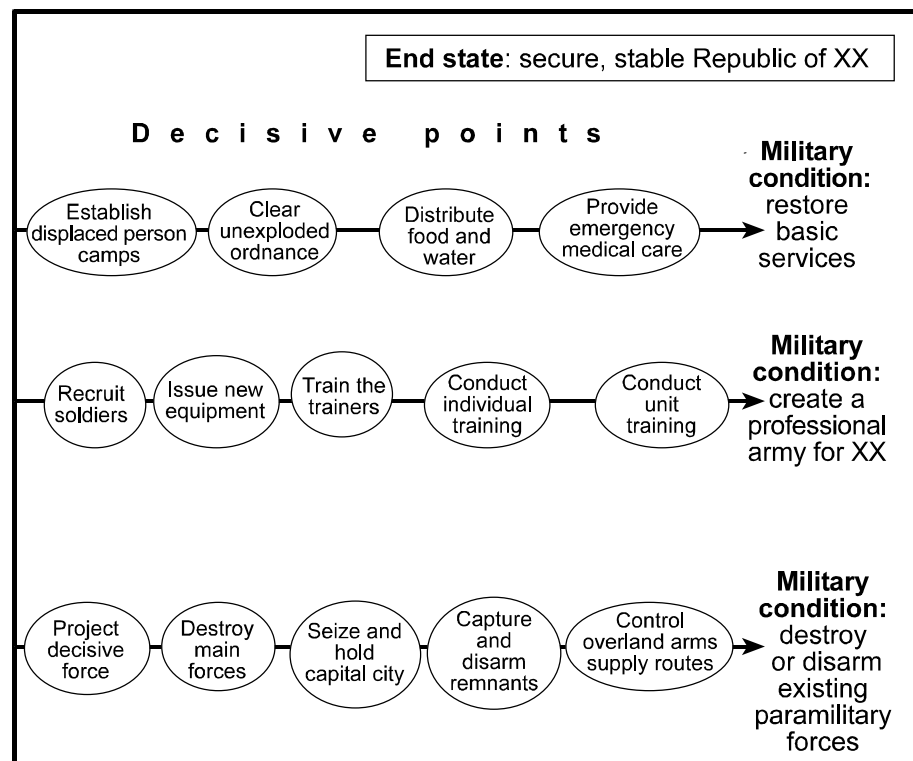

Figure 5-3. Logical Lines of Operations

5-38. **Culminating Point.** Culminating point has both operational and tactical relevance. **In the offense, the *culminating point* is that point in time and space where the attacker's effective combat power no longer exceeds the defender's or the attacker's momentum is no longer sustainable, or both.** Beyond their culminating point, attackers risk counterattack and catastrophic defeat and continue the offense only at great peril. Defending forces reach their culminating point when they can no longer defend successfully or counterattack to restore the cohesion of the

defense. **The defensive culminating point marks that instant at which the defender must withdraw to preserve the force.** Commanders tailor their information requirements to anticipate culmination early enough to either avoid it or, if avoiding it is not possible, place the force in the strongest possible posture.

5-39. In operations where stability or support predominate, culmination may result from the erosion of national will, decline of popular support, questions concerning legitimacy or restraint, or lapses in protection leading to excessive casualties. Operational culmination in a stability or support mission usually occurs when the force is spread too thinly to control the situation, from a lack of resources, or from the inability to supply resources when needed. Then small failures may cascade into larger defeats, shocks in the political arena, or inability to provide the necessary support.

5-40. **Operational Reach, Approach, and Pauses.** Good operational design balances operational reach, operational approach, and operational pauses to ensure the force achieves its objectives before it culminates. Commanders carefully assess the physical and psychological condition of friendly and enemy forces, anticipate culmination, and plan operational pauses if necessary. They commit the required forces and conduct operational risk assessments. Commanders aim to extend operational reach while avoiding culmination and operational pauses.

5-41. **Operational reach is the distance over which military power can be employed decisively.** It is a tether. Operational reach varies based on the situation. Combat power, sustainment capabilities, and the geography surrounding and separating friendly and enemy forces all influence it. Army forces extend their operational reach by locating forces, reserves, bases, and support forward; by increasing the range of weapons systems; through supply discipline; and by improving lines of communications (LOCs).

5-42. **Operational approach is the manner in which a commander attacks the enemy center of gravity. The direct approach applies combat power directly against the enemy center of gravity or the enemy's principal strength. The indirect approach attacks the enemy center of gravity by applying combat power against a series of decisive points that avoid enemy strengths.** When possible, commanders choose an indirect approach: they maneuver to avoid enemy strengths and degrade enemy capabilities; they refuse combat when the situation is unfavorable or the outcome does not significantly affect the operation. An effective operational approach, whether direct or indirect, focuses symmetric and asymmetric effects on the objective. By a shrewd operational approach, careful integration of joint capabilities, and agile BOS combinations, Army forces bring enemies within their operational reach while protecting themselves.

5-43. **An operational pause is a deliberate halt taken to extend operational reach or prevent culmination.** An operational pause may occur because the force has culminated, because the character of the operation has changed (by the intervention of another enemy, for example), or through a combination of other factors. If the situation requires an operational pause, the commander should designate a new main effort. Army forces coordinate

operational pauses with other components so the joint force can maintain the initiative and momentum.

5-44. **Simultaneous and Sequential Operations.** The sequence of operations is closely related to the use of resources. ARFOR commanders synchronize subordinate unit actions in time, space, and effects to link the theater strategy and design of joint major operations to tactical execution. Without this linkage, major operations deteriorate into haphazard battles and engagements that waste resources without achieving decisive results.

5-45. When possible, Army forces conduct simultaneous operations throughout the AO. They seek to employ combat power against the entire enemy system. Army forces concurrently engage as many decisive points as possible. Simultaneity exploits depth and agility to overwhelm enemy forces. It threatens opponents with immediate consequences throughout the AO. The presence of multiple threats overloads enemy C2 systems. Enemy commanders confront many decisions within a very short period. The chance of a serious mistake is high, and each mistake creates opportunities for friendly forces.

5-46. Simultaneous operations place a premium on information superiority and overwhelming combat power. In practical terms, the force size and force projection constraints may limit the ability of Army forces to achieve simultaneity. Effective operational designs employ complementary and reinforcing joint and service capabilities to achieve maximum simultaneity.

5-47. Sequential operations achieve the end state by phases. Commanders concentrate combat power at successive points over time, achieving the mission in a controlled series of steps. Often the scale and scope of the campaign or major operation, together with the resiliency of the enemy, compel commanders to destroy and disrupt the enemy in stages, exposing the center of gravity step by step.

5-48. **Nonlinear and Linear Operations.** Nonlinear operations are now more common than ever. Stability operations and support operations are normally nonlinear. Operation Just Cause and the last 36 hours of Operation Desert Storm featured large-scale nonlinear offensive operations. Ideally, a mobile defense transforms an enemy attack into a nonlinear operation that destroys him.

5-49. In *nonlinear operations*, maneuver units may operate in noncontiguous areas throughout the AO. Even when operating in contiguous AOs, maneuver forces may orient on objectives without geographic reference to adjacent forces. Nonlinear operations typically focus on multiple decisive points. Simultaneity overwhelms opposing C2 and retains the initiative. Nonlinear operations proceed along multiple lines of operations—geographic, logical, or both. LOCs often diverge from lines of operation, and sustaining operations may depend on CSS moving with maneuver units or delivered by air.

5-50. Smaller, lighter, more mobile, and more lethal forces sustained by efficient, distribution-based CSS systems lend themselves to simultaneous operations against multiple decisive points. Situational understanding, coupled with precision fires, frees commanders to maneuver against multiple objectives. Swift maneuver against several decisive points—supported by

precise, concentrated fire—induces paralysis and shock among enemy troops and commanders.

5-51. In *linear operations*, maneuver units normally operate in contiguous AOs. Each combined arms force directs and sustains combat power toward enemy forces in concert with adjacent units. The ratio of forces to space and the array of maneuver forces emphasize geographic position and tend to create a continuous forward line of own troops (FLOT). This protects and simplifies LOCs. Protected LOCs, in turn, increase the endurance of Army forces and ensure freedom of action for extended periods.

5-52. A linear battlefield organization may be best for some operations or certain phases of an operation. Conditions that favor linear operations include those where US forces lack the information needed to conduct nonlinear operations or are severely outnumbered. Linear operations are also appropriate against a deeply arrayed, echeloned enemy force or when the threat to LOCs reduces friendly force freedom of action. In these circumstances, linear operations allow commanders to concentrate and synchronize combat power more easily. Coalition operations may also require a linear design.

5-53. Nonlinear and linear operations are not mutually exclusive. Depending upon perspective and echelon, operations often combine them. For example, a corps may employ its forces in noncontiguous areas, operating simultaneously against multiple decisive points. A brigade combat team in the same corps operating within an urban area may employ units in a linear array.

5-54. **Tempo. Tempo is the rate of military action.** Controlling or altering that rate is necessary to retain the initiative. Army forces adjust tempo to maximize friendly capabilities. Commanders consider the timing of the effects achieved rather than the chronological application of combat power or capabilities. Tempo has military significance only in relative terms. When the sustained friendly tempo exceeds the enemy's ability to react, friendly forces can maintain the initiative and have a marked advantage.

5-55. Commanders complement rapid tempo with three related concepts. First, operational design stresses simultaneous operations rather than a deliberate sequence of operations. Second, an operation may achieve rapid tempo by avoiding needless combat. This includes bypassing resistance that appears at times and places commanders do not consider decisive. Third, the design gives maximum latitude to independent action and initiative by subordinate commanders.

5-56. Army forces generally pay a price for rapid tempo through greater fatigue and resource expenditure. Commanders judge the capacity of their forces to operate at high tempo based on theater resources and deteriorating friendly performance. They design the operation for various tempos that take into account the endurance of the force.

Input from Other Commanders and Staff

5-57. Subordinate, adjacent, and higher commanders use similar factors but different perspectives to visualize their battlespace. Commanders increase the depth and sophistication of their visualizations through exchanges with other commanders. Advanced C2 systems support this collaboration by

allowing commanders to share a common operational picture (COP). In a similar fashion, staff input, in the form of estimates, provides focused analysis of the situation and its potential effects on operations. Commanders direct staffs to provide the information necessary to shape their vision.

The Commander's Experience and Judgment

5-58. Commanders consider the context of the operation, the relationship of Army forces within the joint team, and JFC-designated roles and missions. Experience, combined with situational understanding, provides the intellectual setting around which commanders visualize the operational design. Based upon the commander's direction, Army units plan, prepare, execute, and continuously assess the operation.

5-59. Judgment provides the basis for the considered application of combat power in innovative ways adapted to new situations. In circumstances where experience provides few answers, commanders combine their experience, intuition, and judgment with the recommendations of the staff and subordinates to create new strategies. In many instances, solutions to tough questions may come from the reasoned application of historical study, a hallmark of professional development. In other situations, small unit leaders or soldiers invent solutions to tactical problems. When proposed solutions appear, commanders consider them and decide on appropriate actions.

Experience and Innovation on Grenada

In October 1983, Army forces invaded Grenada as part of Joint Task Force 120. During operations on 27 October, paratroopers from the 82d Airborne Division advanced eastward across southern Grenada. Army forces cleared all enemy forces in their AO, phase line by phase line. During operations, soldiers discovered that runway problems at Point Salines had delayed the arrival of the division's attack helicopters, a critical means of fire support. Without the helicopters, the 82d soldiers relied upon naval aircraft and naval gunfire. Their tactical radios, however, were incompatible with communications systems aboard the ships of the *Independence* battle group. Army soldiers invented a solution to their dilemma by using commercial telephone cards to send their request for fire support to Fort Bragg, North Carolina. Fort Bragg personnel then relayed the requests via satellite to the ships. Army soldiers developed an innovative solution to a complex problem and, by doing so, helped to identify and later correct the joint compatibility issues.

DESCRIBE

5-60. To describe operations, commanders use operational framework and elements of operational design to relate decisive, shaping, and sustaining operations to time and space. In all operations, purpose and time determine the allocation of space. Commanders clarify their description, as circumstances require. They emphasize how the combination of decisive, shaping, and sustaining operations relates to accomplishing the purpose of the overall operation. When appropriate, commanders include deep, close, and rear areas

in the battlefield organization. Whether commanders envision linear or nonlinear operations, combining the operational framework with the elements of operational design provides a flexible tool to describe actions. Commanders describe their vision in their commander's intent and planning guidance, using terms suited to the nature of the mission and their experience.

Commander's Intent

5-61. Commanders express their vision as the commander's intent. The staff and subordinates measure the plans and orders that transform thought to action against it. **The commander's intent is a clear, concise statement of what the force must do and the conditions the force must meet to succeed with respect to the enemy, terrain, and the desired end state.** Commanders make their own independent, and sometimes intuitive, assessment of how they intend to win. The final expression of intent comes from commanders personally.

5-62. Intent, coupled with mission, directs subordinates toward mission accomplishment in the absence of orders. When significant opportunities appear, subordinates use the commander's intent to orient their efforts. Intent includes the conditions that forces meet to achieve the end state. Conditions apply to all courses of action. They include the tempo, duration, effect on the enemy, effect on another friendly force operation, and key terrain.

Commander's Intent and Sherman's "March to the Sea"

On 4 April 1864, LTG Ulysses S. Grant wrote to MG William T. Sherman regarding his plan for conducting a spring campaign against the Confederacy. LTG Grant conveyed his intent to "take the initiative in the spring campaign, to work all parts of the army together, and somewhat toward a common center." LTG Grant informed MG Sherman of what his fellow commanders would be doing to accomplish that intent. Then he told MG Sherman to "move against Johnston's army, to break it up and to get into the interior of the enemy's country as far as you can, inflicting all the damage you can against their war resources. I do not propose to lay down for you a plan of campaign, but simply lay down the work it is desirable to have done and leave you free to execute it in your own way. Submit to me, however, as early as you can, your plan of operations."

LTG Grant understood that by asking MG Sherman to penetrate deep into enemy territory he would occasionally lose communications with his subordinate. Yet, he trusted that MG Sherman understood what he was to do, adding, "I believe you will accomplish it." The operation that resulted from this intent was MG Sherman's "march to the sea." The operation forced the Confederacy to divert resources from the forces opposing the Union main effort by the Army of the Potomac and hastened the end of the war.

Planning Guidance

5-63. From the vision, commanders develop and issue planning guidance. Planning guidance may be either broad or detailed, as circumstances dictate. However, it conveys the essence of the commander's vision. Commanders use their experience and judgment to add depth and clarity to their planning guidance. Commanders attune the staff to the broad outline of their vision, while still permitting latitude for the staff to explore different options.

Planning Guidance—Grant and Thomas at Chattanooga

On 18 November 1863, MG Ulysses S. Grant gave MG George H. Thomas his planning guidance for seizing Confederate positions near Chattanooga, Tennessee, a critical city lying along vital Confederate LOCs. MG Grant told MG Thomas of his plan for a daylight assault to seize Missionary Ridge, thereby gaining key terrain from which to weaken the Confederate defense. He stated that “the general plan, you understand, is for Sherman to effect a crossing of the Tennessee River just below the mouth of Chickamauga...to secure the heights on the northern extremity to about the railroad tunnel before the enemy can concentrate against him. You will cooperate with Sherman. The troops in Chattanooga Valley should be well concentrated on your left flank, leaving only the necessary force to defend fortifications on the right and center, and a movable column of one division in readiness to move wherever ordered. Your effort then will be to form a junction with Sherman, making your advance well towards the northern end of Missionary Ridge, and moving as near simultaneously with him as possible.” Once the two forces converged, MG Thomas was told to establish communications “at once between the two armies by roads on the south bank of the river.” MG Grant intended to move fast; thus, he added that wanted the troops to be “provided with two days’ cooked rations in haversacks and one hundred rounds of ammunition on the person of each infantry soldier.” MG Grant’s guidance was simple and clear. MG Thomas accomplished his mission, and the Union Army defeated the Confederate forces at Chattanooga.

DIRECT

5-64. Armed with a coherent and focused intent, commanders and staffs develop the concept of operations and synchronize the BOS. The BOS are the physical means (soldiers, organizations, and equipment) used to accomplish the mission. The BOS group related systems together according to battlefield use. Information about specific tasks associated with each BOS is in FM 7-15.

The Battlefield Operating Systems

- Intelligence
- Maneuver
- Fire support
- Air defense
- Mobility/countermobility/survivability
- Combat service support
- Command and control

Intelligence

5-65. The intelligence system plans, directs, collects, processes, produces, and disseminates intelligence on the threat and environment to perform intelligence preparation of the battlefield (IPB) and the other intelligence tasks. A critical part of IPB involves collaborative, cross-BOS analysis across echelons and between analytic elements of a command. The other intelligence tasks are—

- Situation development.
- Target development and support to targeting.
- Indications and warning.
- Intelligence support to battle damage assessment.
- Intelligence support to force protection.

Intelligence is developed as a part of a continuous process and is fundamental to all Army operations.

Maneuver

5-66. Maneuver systems move to gain positions of advantage against enemy forces. Infantry, armor, cavalry, and aviation forces are organized, trained, and equipped primarily for maneuver. Commanders maneuver these forces to create conditions for tactical and operational success. By maneuver, friendly forces gain the ability to destroy enemy forces or hinder enemy movement by direct and indirect application of firepower, or threat of its application.

Fire Support

5-67. Fire support consists of fires that directly support land, maritime, amphibious, and special operations forces in engaging enemy forces, combat formations, and facilities in pursuit of tactical and operational objectives. Fire support integrates and synchronizes fires and effects to delay, disrupt, or destroy enemy forces, systems, and facilities. The fire support system includes the collective and coordinated use of target acquisition data, indirect-fire weapons, fixed-wing aircraft, electronic warfare, and other lethal and nonlethal means to attack targets. At the operational level, maneuver and fires may be complementary in design, but distinct in objective and means.

Air Defense

5-68. The air defense system protects the force from air and missile attack and aerial surveillance. It prevents enemies from interdicting friendly forces while freeing commanders to synchronize maneuver and firepower. All members of the combined arms team perform air defense tasks; however, ground-based air defense artillery units execute most Army air defense operations. These units protect deployed forces and critical assets from observation and attack by enemy aircraft, missiles, and unmanned aerial vehicles. The WMD threat and proliferation of missile technology increase the importance of the air defense system. Theater missile defense is crucial at the operational level.

Mobility/Counter-mobility/Survivability

5-69. *Mobility* operations preserve friendly force freedom of maneuver. *Mobility* missions include breaching obstacles, increasing battlefield circulation,

improving or building roads, providing bridge and raft support, and identifying routes around contaminated areas. *Countermobility* denies mobility to enemy forces. It limits the maneuver of enemy forces and enhances the effectiveness of fires. Countermobility missions include obstacle building and smoke generation. *Survivability* operations protect friendly forces from the effects of enemy weapons systems and from natural occurrences. Hardening of facilities and fortification of battle positions are active survivability measures. Military deception, OPSEC, and dispersion can also increase survivability. NBC defense measures are essential survivability tasks.

Combat Service Support

5-70. CSS includes many technical specialties and functional activities. It includes the use of host nation infrastructure and contracted support. CSS provides the physical means for forces to operate, from the production base and replacement centers in the continental US to soldiers engaged in close combat. It is present across the range of military operations, at all levels of war.

Command and Control

5-71. Command and control has two components—the commander and the C2 system. Communications systems, intelligence systems, and computer networks form the backbone of C2 systems and allow commanders to lead from any point on the battlefield. The C2 system supports the commander's ability to make informed decisions, delegate authority, and synchronize the BOS. Moreover, the C2 system supports the ability of commanders to adjust plans for future operations, even while focusing on the current fight. Staffs work within the commander's intent to direct units and control resource allocations. They also are alert to spotting enemy or friendly situations that require command decisions and advise commanders concerning them. Through C2, commanders initiate and integrate all military functions and systems toward a common goal: mission accomplishment (see FM 6-0).

Command and control is the exercise of authority and direction by a properly designated commander over assigned and attached forces in the accomplishment of the mission. Command and control functions are performed through an arrangement of personnel, equipment, communications, facilities, and procedures employed by a commander in planning, directing, coordinating, and controlling forces and operations in the accomplishment of the mission.

5-72. Reliable communications are central to C2 systems. Effective battle command requires reliable signal support systems that enable commanders to conduct operations at varying tempos. Nonetheless, commanders, not their communication systems, dictate command style. Signal planning increases the commander's options by providing signal support to pass vital information at critical times. This capability allows commanders to leverage tactical success and anticipate future operations. Communications planning is a vital component of maintaining or extending operational reach.

PERSONAL IMPACT OF THE COMMANDER

5-73. Command occurs at the commander's location, whether at a command post, infiltrating at night with light infantry elements, or in a combat vehicle with the decisive operation. Commanders balance inspiring soldiers through leading by example with the need to maintain C2 continuity. Even when equipped with advanced C2 systems, commanders carefully consider their personal location and its impact on their ability to recognize opportunities. In larger tactical and operational formations, the command post is normally the focus of information flow and planning. There, information systems, the staff, and the COP enhance commanders' ability to visualize possibilities and recognize opportunities. Yet there are times when commanding from forward locations is necessary. Plans should account for such temporary requirements as well as the possible loss of the commander. Commanders at all levels locate where they can not only exercise command but also sense the battle. Sometimes this is at the command post; sometimes it is face to face with subordinate commanders and soldiers.

5-74. The commander's will is the constant element that propels the force through the shock and friction of battle. Things can and will go wrong. The ability of leaders and soldiers to concentrate erodes as they reach the limits of their endurance. If the enemy is skilled and resolute, soldiers may approach that point when "can't be done" and "can't go any further" dominate their thinking. At that point, the will and personal presence of commanders provide the impetus for action.

Modern land warfare is tough, uncompromising, and highly lethal. The enemy is found and engaged at ranges from a few meters to thousands of meters. Casualties are sudden and unexpected even though you know they will happen. Because of that, commanders and soldiers at every level are aware not only of the tactical, operational, and strategic problem solving demands of war but also the intense human dimension. They know results are final and will be frozen in time for a lifetime. Objectives are achieved but always at a cost to your soldiers. It is why at all levels the aim always is mission at least cost. Often that least cost is achieved by seizing the initiative and by bold action. Commanders and soldiers have to feel it all to really know what to do. But in feeling it all they must not be paralyzed into inaction. They must decide, often in nanoseconds, make the decision stick, and go on. They must feel but they also must act. They cannot give in to second guessing themselves nor to their emotions. That is what makes combat leadership so demanding. It is why commanders train hard and continually throughout a professional lifetime so they can make the few tough decisions they have to make in battle to put their soldiers at the best possible advantage over the enemy. Soldiers trust battle commanders to be able to do that, but also to assume responsibility when things do not go as planned and quickly make the right adjustments to keep them at that advantage.

General Frederick M. Franks Jr.
VII Corps Commander, Operation Desert Storm

Chapter 6

Conducting Full Spectrum Operations

I think the time has come when we should attempt the boldest moves, and my experience is that they are easier of execution than more timid ones...

Major General William Tecumseh Sherman

6-1. While differing dramatically in their particulars, full spectrum operations follow a cycle of planning, preparation, execution, and continuous assessment. These cyclic activities are sequential but not discrete; they overlap and recur as circumstances demand. As a whole, they make up the *operations process*. Battle command drives the operations process (see Figure 6-1, page 6-2). Army forces design and conduct operations to win on the offensive; dictate the terms of combat and avoid fighting the enemy on his terms; seize and retain the initiative; and build momentum quickly to win decisively.

CONTENTS	
Plan	6-1
Operational and Tactical Planning.....	6-3
Phasing	6-4
Branches and Sequels	6-5
Concept of Operations	6-5
Risk Management	6-6
Orders	6-6
Prepare.....	6-6
Staff Preparation	6-7
Unit Preparation	6-7
Individual Preparation	6-7
Rules of Engagement	6-7
Execute	6-9
Seize and Retain the Initiative	6-9
Build and Maintain Momentum.....	6-10
Exploit Success	6-12
Combine Decisive, Shaping, and Sustaining Operations	6-13
Complex Operational Considerations ..	6-17
Follow-On Operations	6-20
Assess	6-22

PLAN

6-2. The commander's intent and planning guidance direct the activities of the staff and subordinate commanders. The staff assists the commander with the coordination and detailed analysis necessary to convert the planning guidance and commander's intent into a plan. The plan becomes a common reference point for operations (see FM 5-0).

6-3. **Planning is the means by which the commander envisions a desired outcome, lays out effective ways of achieving it, and communicates to his subordinates his vision, intent, and decisions, focusing on the results he expects to achieve.** Plans forecast but do not predict. A plan is a continuous, evolving framework of anticipated actions that

maximizes opportunities. It guides subordinates as they progress through each phase of the operation. Any plan is a framework from which to adapt, not a script to be followed to the letter. The measure of a good plan is not whether execution transpires as planned but whether the plan facilitates effective action in the face of unforeseen events. Good plans foster initiative.

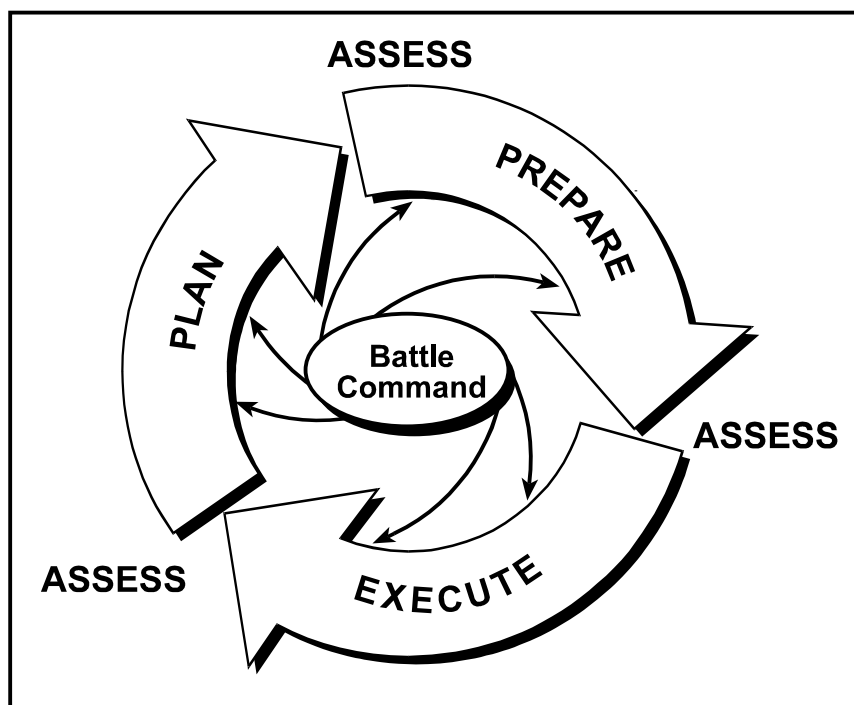

Figure 6-1. The Operations Process

6-4. Scope, complexity, and length of planning horizons differ between operational and tactical planning. Campaign planning coordinates major actions across significant periods. Planners mesh service capabilities with those of joint and multinational formations as well as interagency and nongovernmental organizations. Tactical planning has the same clarity of purpose as operational planning, but has a shorter planning horizon. Comprehensive, continuous, and adaptive planning characterizes successful operations at both the operational and tactical levels.

6-5. Plans specify what commanders will decide personally. In the offense, for example, commanders normally decide when to commit the reserve. In a tense stability operation, the commander may decide the exact positions of tactical elements. Regardless of echelon, commanders identify those information requirements they consider most important to their decisions—the commander's critical information requirements (CCIR). These are typically information requirements that help them confirm their vision of the battlefield or identify significant deviations from it. The staff incorporates CCIR into the appropriate parts of the plan and passes them to subordinate units.

6-6. Plans give subordinates the latitude and guidance to exercise disciplined initiative within the bounds of the commander's intent. For example, aviation and ground maneuver elements might attack enemy missiles capable of

delivering weapons of mass destruction (WMD) wherever located, no matter what their mission at the time. Some operations require tight control over subordinate elements. However, commanders ensure that plans remain as flexible as possible and impose the minimum control required for mission success. Commanders encourage subordinates to seize the initiative through plans and directions that provide guidance concerning opportunity.

6-7. German Field Marshal Helmuth von Moltke (victor in the Franco-Prussian war of 1870) observed that “no plan...extends with any degree of certainty beyond the first encounter with the main enemy force.” This is as true today as it was more than a century ago. Moltke’s dictum, rather than condemning the value of planning, reminds commanders and staffs of the relationship between planning and execution during operations. The purpose of any plan is to establish the conceptual basis for action. The plan provides a reasonably accurate forecast of execution. However, it remains a starting point, not the centerpiece of the operation. As GEN George S. Patton Jr. cautioned, “...one makes plans to fit circumstances and does not try to create circumstances to fit plans. That way danger lies.”

OPERATIONAL AND TACTICAL PLANNING

6-8. Planning is dynamic and continuous (see JP 5-0). Operational-level planning focuses on developing plans for campaigns, subordinate campaigns, and major operations. Combatant commanders develop theater campaign plans to accomplish multinational, national, and theater strategic objectives. Subordinate unified commands typically develop subordinate campaign plans or operation plans that accomplish theater strategic objectives. Joint task force (JTF) commanders may develop subordinate campaign plans if the mission requires military operations of sufficient scope, size, complexity, and duration. Land component commanders normally develop plans for major operations that support the campaign plan.

6-9. In major operations, Army force commanders choose to accept or decline battle, decide what use to make of tactical successes and failures, and advise joint force commanders (JFCs) on the long-term needs and prospects of their operations. Since campaign plans generally set a series of long-term objectives, they often require phases. Therefore, a campaign plan normally provides a general concept of operations for the entire campaign and a specific operation order for the campaign’s initial phase. Planning for major operations mirrors planning for the overall campaign but is reduced in scope. Even if a major operation is not the initial phase of a campaign, planning for it as a branch or a sequel may begin long before actual execution.

6-10. Operational and tactical planning complement each other but have different aims. Operational planning prepares the way for tactical activity on favorable terms; it continually seeks to foster and exploit tactical success. Major operations depend on creatively using tactical actions to accomplish strategic or operational purposes in specific contexts against adaptive opponents. Tactical planning emphasizes flexibility and options. Planning horizons for tactical actions are relatively short. Comprehensive planning may be feasible only for the first engagement or phase of a battle; succeeding actions depend on enemy responses and circumstances. The art of tactical planning lies in anticipating and developing sound branches and sequels.

6-11. Brevity is essential; so is speed. Staffs must avoid consuming too much time developing lengthy plans that contain irrelevant details. When plans arrive late, subordinate units can only react. To save time and shorten plans, commanders and staffs anticipate support requirements and forecast options. Headquarters at each level plan in parallel with higher and lower headquarters. Parallel planning expedites the exchange of information among headquarters and should be used as much as possible. Commanders exploit technology to increase situational understanding and speed of planning.

Change of Plans at Normandy

On 6 June 1944, Army forces executed Operation Overlord, an air and sea invasion of Western Europe. VII Corps planned an assault on Utah Beach by the 4th Infantry Division along with predawn airborne drops by the 82d and 101st Airborne Divisions. Like most D-Day operations, events proceeded differently than planned.

Upon execution, the airborne units were scattered across the French countryside with some units forming quickly while others grouped into small, isolated pockets. Regardless, airborne troops pressed on to their objectives or fought where they were, creating disorder among the defenders.

The 4th Infantry Division landed at Utah Beach where, of four beach control vessels guiding the force, one broke down and two others were sunk. The remaining vessel guided the landing force to the beaches, but they arrived south of their designated areas. BG Theodore Roosevelt Jr., the assistant division commander, made a personal reconnaissance and realized that the original plan must change. He returned to the landing site and ordered the two infantry battalions to advance inland instead of realigning onto the original amphibious landing sites, a decision that was executed without confusion. Changing plans fit the circumstances, and the 4th Infantry Division successfully pressed the fight inland.

6-12. There are two doctrinal planning procedures (see FM 5-0). In units with a formally organized staff, the military decision making process helps commanders and staffs develop estimates, plans, and orders. It provides a logical sequence of decision and interaction between the commander and staff. The military decision making process provides a common framework for all staffs that supports the maximum use of parallel planning. At the lowest tactical echelons, commanders do not have a staff. Consequently, commanders and leaders follow the troop leading procedures. Both procedures hinge on the commander's ability to visualize and describe the operation. Both are means to an end: their value lies in the result, not the process.

PHASING

6-13. A **phase** is a specific part of an operation that is different from those that precede or follow. A change in phase usually involves a change of task. Phasing assists in planning and controlling. Considerations of time, distance, terrain, resources, and important events contribute to the decision to phase an operation.

6-14. If Army forces lack the means to overwhelm an enemy in a single simultaneous operation, then commanders normally phase the operation. A phase is a period when a large portion of the force conducts similar or mutually supporting activities. Operations link successive phases. Individual phases gain significance only in the larger context of the campaign or major operation. Each phase should strive for simultaneity in time, space, and purpose. In this way, commanders combine simultaneous operations within phases while sequencing operations to achieve the end state.

6-15. Links between phases and the requirement to transition between phases are critically important. Commanders establish clear conditions for how and when these transitions occur. Although phases are distinguishable to friendly forces, the operational design conceals these distinctions from opponents through concurrent, complementary joint and Army actions.

BRANCHES AND SEQUELS

6-16. Operations never proceed exactly as planned. An effective design places a premium on flexibility. Commanders incorporate branches and sequels into the operational design to gain flexibility. Visualizing and planning branches and sequels are important because they involve transition—changes in mission, in type of operation, and often in forces required for execution. Unless planned and executed efficiently, transitions can reduce the tempo of the operation, slow its momentum, and cede the initiative to the adversary.

6-17. **A *branch* is a contingency plan or course of action (an option built into the basic plan or course of action) for changing the mission, disposition, orientation, or direction of movement of the force to aid success of the current operation, based on anticipated events, opportunities, or disruptions caused by enemy actions. Army forces prepare branches to exploit success and opportunities, or to counter disruptions caused by enemy actions.** Commanders anticipate and devise counters to enemy actions. Although anticipating every possible threat action is impossible, branches anticipate the most likely ones. Commanders execute branches to rapidly respond to changing conditions.

6-18. ***Sequels* are operations that follow the current operation. They are future operations that anticipate the possible outcomes—success, failure, or stalemate—of the current operation.** A counteroffensive, for example, is a logical sequel to a defense; exploitation and pursuit follow successful attacks. Executing a sequel normally begins another phase of an operation, if not a new operation. Commanders consider sequels early and revisit them throughout an operation. Without such planning, current operations leave forces poorly positioned for future opportunities, and leaders are unprepared to retain the initiative. Both branches and sequels should have execution criteria, carefully reviewed before their implementation and updated based on assessment of current operations.

CONCEPT OF OPERATIONS

6-19. **The *concept of operations* describes how commanders see the actions of subordinate units fitting together to accomplish the mission. As a minimum, the description includes the scheme of**

maneuver and concept of fires. The concept of operations expands the commander's selected course of action and expresses how each element of the force will cooperate to accomplish the mission. Where the commander's intent focuses on the end state, the concept of operations focuses on the method by which the operation uses and synchronizes the battlefield operating systems (BOS) to translate vision and end state into action. Commanders ensure that the concept of operations is consistent with both their intent and that of the next two higher commanders.

RISK MANAGEMENT

6-20. **Risk management is the process of identifying, assessing, and controlling risk arising from operational factors, and making an informed decision that balances risk cost with mission benefits.** It provides leaders with a systematic mechanism to identify risk associated with a course of action during planning (see FM 3-100.14; FM 5-0). Commanders integrate risk management into all aspects of the operations process. During planning, commanders identify, assess, and weigh risks. They convey risk considerations as guidance. Risk guidance affects course of action development. It also affects application of some elements of operational design, such as end state, designation of objectives, and lines of operation. Risk management also influences task organization; control measures; and the concepts of operations, fires, and CSS. During execution, assessment of risk assists commanders in making informed decisions regarding changes to task organization, shifting priorities of effort and support, and shaping future operations. Effective risk management results in mission accomplishment at least cost.

ORDERS

6-21. Orders translate plans into execution. When possible, commanders issue them personally, face-to-face. If this is not possible, a video teleconference or other communication means can substitute. Commanders allow their subordinates maximum freedom of action, providing mission-type orders whenever practical. Mission-type orders specify what to do and the purpose for doing it, without prescribing how to do it (see FM 6-0). Control measures should aid cooperation among forces without imposing needless restrictions on their freedom of action.

PREPARE

6-22. **Preparation consists of activities by the unit before execution to improve its ability to conduct the operation including, but not limited to, the following: plan refinement, rehearsals, reconnaissance, coordination, inspections, and movement.** It requires staff, unit, and soldier actions. The complexity of operations imposes significant challenges. The nature of land operations differs tremendously from situation to situation. Mission success depends as much on preparation as planning. Rehearsals help staffs, units, and individuals to prepare for full spectrum operations. Preparation includes a range of activities. These include mission rehearsals, brief-backs, equipment and communications checks, standing operating procedure (SOP) reviews, load plan verification, soldier readiness preparation, and weapons test-firing.

STAFF PREPARATION

6-23. Each staff section and element conducts activities to maximize the operational effectiveness of the force. Coordination between echelons and preparation that precedes execution are just as important, if not more important, than developing the plan. Staff preparation includes assembling and continuously updating estimates. For example, continuous intelligence preparation of the battlefield (IPB) provides accurate situational updates for commanders when needed. Whether incorporated into a formal process or not, the preparatory activities of staff sections and force elements inform planning and continue throughout preparation and execution. Updated estimates form the basis for staff recommendations; the value of current, reasonably accurate estimates increases exponentially with tempo.

UNIT PREPARATION

6-24. Warfighting skills developed and honed in training form the base of mission success. Without the Army's ability to fight and win, commitment of its units to a theater would entail unacceptable risks. Combat-ready units can adapt readily to noncombat situations; units not trained to standard cannot survive in combat situations. The knowledge, discipline, cohesion, and technical skill necessary to defeat an enemy are also fundamental for success in environments that seem far removed from the battlefield. The combat capability of Army forces is the basis for all it does. In a stability operation, the threat of force may deter escalation. In a support operation, it may preempt violence and lawlessness.

6-25. The tempo may not allow commanders to withdraw entire formations for extensive reorganization and training. However, Army unit modularity lets commanders designate some elements for training while the rest of the force continues the mission. This concurrent training may take place in theater-designated training areas, where units receive intensified maintenance support while conducting individual and collective training. The creation of training areas is both necessary and a challenge for Army commanders.

INDIVIDUAL PREPARATION

6-26. Before the force deploys, soldiers prepare for overseas action. Army units frequently receive augmentation and replacements during preparation for deployment. Commanders pay special attention to the reception and preparation of these soldiers and to integrating their families into support groups. In addition to preparing replacements for deployment, commanders ensure that gaining units rapidly assimilate them as team members.

RULES OF ENGAGEMENT

6-27. Operational requirements, policy, and law define rules of engagement (ROE). ROE always recognize the right of self-defense, the commander's right and obligation to protect assigned personnel, and the national right to defend US forces, allies, and coalition participants against armed attack. The Joint Chiefs of Staff standing ROE provide baseline guidance (see CJCSI 3121.01A). The standing ROE may be tailored and supplemented for specific operations to meet commanders' needs. Effective ROE are enforceable, understandable, tactically sound, and legally sufficient. Further,

effective ROE are responsive to the mission and permit subordinate commanders to exercise initiative when confronted by opportunity or unforeseen circumstances.

6-28. In all operations, whether using lethal or nonlethal force, ROE may impose political, practical, operational, and legal limitations upon commanders. Commanders factor these constraints into planning and preparation as early as possible. Withholding employment of particular classes of weapons and exempting the territory of certain nations from attack are examples of such limitations. Tactically, ROE may extend to criteria for initiating engagements with certain weapons systems (for example, unobserved fires) or reacting to an attack. ROE never justify illegal actions. In all situations, soldiers and commanders use the degree of force that is militarily necessary, proportional to the threat, and prudent for future operations.

6-29. ROE do not assign specific tasks or require specific tactical solutions; they allow commanders to quickly and clearly convey to subordinates a desired posture regarding the use of force. In passing orders to subordinates, commanders act within the ROE received. However, ROE never relieve commanders from the responsibility to formulate an operational design. The end state, objectives, and mission must be clear. Commanders at all levels continually review the ROE to ensure their effectiveness in light of current and projected conditions. Such considerations may include ROE for computer network attack. Soldiers who thoroughly understand ROE are better prepared to apply the proper balance of initiative and restraint.

Home Station, Predeployment, and Deployment Training

In 1995, the 1st Armored Division changed its mission essential task list (METL) to prepare for peace enforcement operations in Bosnia. The nature of ongoing diplomatic negotiations created difficult circumstances for commanders trying to determine when they would deploy. Regardless, the on-again, off-again nature of diplomatic negotiations allowed the 1st Armored Division to transition from a wartime to a peacekeeping METL. The division made maximum use of the available time, undergoing a two-month intensive training and certification process at home station and the Combat Maneuver Training Center, Hohenfels, Germany. Commanders and staff participated in command post exercises designed to match Balkan political-military realities, while leaders and soldiers engaged in situational training exercises and cold weather training. Upon deployment, observers from the Center for Army Lessons Learned accompanied the division and observed ongoing operations. Center for Army Lessons Learned members sent reports to Combat Maneuver Training Center trainers, who updated existing training scenarios to match changing operational conditions in the theater. The division also continued training after deployment to keep a warfighting edge during the peace enforcement operation. 1st Armored Division maneuver battalion soldiers rotated from Bosnia to Taborfalva Training Area in Hungary once during their tour. There they underwent gunnery qualification. The soldiers then returned to Bosnia and resumed their mission.

EXECUTE

6-30. Execution is concerted action to seize and retain the initiative, build and maintain momentum, and exploit success. The tenet of initiative is fundamental to success in any operation, yet simply seizing the initiative is not enough. A sudden barrage of precision munitions may surprise and disorganize the enemy, but if not followed by swift and relentless action, the advantage diminishes and disappears. Successful operations maintain the momentum generated by initiative and exploit successes within the commander's intent.

SEIZE AND RETAIN THE INITIATIVE

6-31. Initiative gives all operations the spirit, if not the form, of the offense. Operationally, seizing the initiative requires leaders to anticipate events so their forces can see and exploit opportunities faster than the enemy. Once they seize the initiative, Army forces exploit opportunities it creates. Initiative requires constant effort to force an enemy to conform to friendly purposes and tempo while retaining friendly freedom of action. From the leader's perspective, commanders place a premium on audacity and making reasoned decisions under uncertain conditions. The commander's intent and aggressiveness of subordinates create conditions for exercising disciplined initiative.

6-32. Enemies who gain and maintain the initiative compel Army forces to react to their strengths and asymmetric capabilities. Ways enemies may try to do this include attempting to neutralize US technological and organizational superiority, adapting the tempo to their capabilities, and outlasting Army forces. Therefore, Army forces seize the initiative as soon as possible and dictate the terms of action throughout the operation. Army forces compel the adversary to accept action on terms established by friendly forces. Provoked to react to US actions, the adversary cedes the initiative and opens himself to exploitation when he errs or fails to react quickly enough.

Take Action

6-33. Commanders create conditions for seizing the initiative by acting. Without action, seizing the initiative is impossible. Faced with an uncertain situation, there is a natural tendency to hesitate and gather more information to reduce the uncertainty. However, waiting and gathering information might reduce uncertainty, but will not eliminate it. Waiting may even increase uncertainty by providing the enemy with time to seize the initiative. It is far better to manage uncertainty by acting and developing the situation. When the immediate situation is unclear, commanders clarify it by action, not sitting and gathering information.

6-34. Commanders identify times and places where they can mass the effects of combat power to relative advantage. To compel a reaction, they threaten something the enemy cares about—his center of gravity or decisive points leading to it. By forcing the enemy to react, commanders initiate an action-to-reaction sequence that ultimately reduces enemy options to zero. Each action develops the situation further and reduces the number of possibilities to be considered, thereby reducing friendly uncertainty. Each time the enemy must react, his uncertainty increases. Developing the situation by forcing the enemy to react is the essence of seizing and retaining the initiative.

6-35. Action is not solely offensive. Force projection may initiate enemy reactions. Movement of forces, together with military deception, often triggers an enemy response. Commanders may deter or induce a desired enemy action by beginning defensive preparations. Aggressive reconnaissance, in particular, allows commanders at every level to gain and maintain contact with enemy forces. Reconnaissance develops the situation, protects friendly forces from surprise, and retains the initiative. Action includes force protection activities that preclude or reduce specific enemy threats.

Create and Exploit Opportunities

6-36. Events that offer better ways to success are opportunities. The key to recognizing them is continuous monitoring of the battlespace in light of the objectives and the commander's intent. Failure to understand the opportunities inherent in an enemy's action surrenders the initiative. CCIR must include elements that support seizing and retaining the initiative so soldiers can recognize opportunities as they develop.

6-37. Commanders encourage subordinates to act within their intent as opportunities occur. Vision, clear communication of intent, and the command climate create an atmosphere conducive to the exercise of subordinate initiative. Digitized information processes, the common operational picture (COP), and situational understanding enhance commanders' ability to recognize possibilities, visualize opportunities, and share them with others.

Assess and Take Risk

6-38. Uncertainty and risk are inherent in all military operations. Recognizing and acting on opportunity means taking risks. Reasonably estimating and intentionally accepting risk is not gambling. Carefully determining the risks, analyzing and minimizing as many hazards as possible, and executing a supervised plan that accounts for those hazards contributes to successfully applying military force. Gambling, in contrast, is imprudently staking the success of an entire action on a single, improbable event. Commanders assess risk in ascending orders of magnitude by answering three questions:

- Am I minimizing the risk of losses?
- Am I risking the success of the operation?
- Am I risking the destruction of the force itself?

6-39. When commanders embrace opportunity, they accept risk. Audacity is a catalyst that can reverse a situation through its influence on enemy perception. It is counterproductive to wait for perfect preparation and synchronization. The time taken to issue complete orders across successive nets could mean an opportunity lost. It is far better to quickly summarize the essentials, get things moving, and send the details later. Leaders optimize the use of time with warning orders, fragmentary orders, and routine COP updates. Too great a desire for orderliness leads to overdetailed orders, overcontrol, and failure to seize and retain the initiative.

BUILD AND MAINTAIN MOMENTUM

6-40. Army forces fight thinking, adaptive enemies. Presented with consistent patterns of activity, enemies devise countermeasures. The benefits of

seizing the initiative do not last long, given enemy determination to overthrow the friendly design. Momentum retains and complements initiative.

6-41. Momentum derives from seizing the initiative and executing shaping, sustaining, and decisive operations at a high tempo. Momentum allows commanders to create opportunities to engage the enemy from unexpected directions with unanticipated capabilities. Having seized the initiative, commanders continue to control the relative momentum by maintaining focus and pressure, and controlling the tempo. They ensure that they maintain momentum by anticipating transitions and moving rapidly between types of operations. When the opportunity presents itself to exploit, commanders push all available forces to the limit to build on momentum gained.

Maintain Focus

6-42. In the stress of combat, a commander's instinct may be to focus on the dangers enemy activity poses. That concern is valid, but it must not cloud the commander's primary focus: achieving his own purpose and objectives. Commanders assess enemy activity in terms of the end state and concentrate on what their forces can do to attain it.

...I am heartily tired of hearing about what Lee is going to do. Some of you always seem to think he is suddenly going to turn a double somersault and land in our rear and on both flanks at the same time. Go back to your command and try to think what we are going to do ourselves, instead of what Lee is going to do.

Lieutenant General U.S. Grant
Battle of the Wilderness, 1864

Further, commanders assess the situation to determine how they can best attack enemy decisive points and protect friendly ones. Commanders evaluate the current situation, seeking opportunities to turn enemy activity to their immediate advantage.

Pressure the Enemy

6-43. Pressure derives from the uninterrupted pace, level, and intensity of activity applied to an enemy. Once Army forces gain contact, they maintain it. Constant pressure and prompt transition to an exploitation deny the enemy time to regain balance and react. Operational pauses, even if intentional and designed to improve a combat service support (CSS) posture or restore order, may carry real dangers—to include potential loss of the hard-won benefits of the offensive. Army forces press relentlessly without hesitation and are ruthlessly opportunistic.

6-44. Adept commanders anticipate the need to maintain appropriate forces suitably positioned for exploitation and continuity of action. As maneuver forces slow and approach culmination, commanders consider the best way to maintain tempo and continue to press the enemy. Commanders can replace the leading units with fresh forces, reinforce the lead units, or apply precision fires against targets in depth. As long as the force in contact can maintain pressure and is not approaching a culminating point, reinforcement is generally preferable to battle handover. Operational fires may also create new opportunities for pressing the enemy by complementing maneuver.

Control the Tempo

6-45. Speed promotes surprise and can compensate for lack of forces. It magnifies the impact of success in seizing the initiative. By executing at a rapid tempo, Army forces present enemies with new problems before they can solve current ones. Rapid tempo should not degenerate into haste. Ill-informed and hasty action usually precludes effective combinations of combat power; it may lead to unnecessary casualties. The condition of the enemy force dictates the degree of synchronization necessary. When confronted by a coherent and disciplined enemy, commanders may slow the tempo to deliver synchronized blows. As the enemy force loses cohesion, commanders increase the tempo, seeking to accelerate the enemy's moral and physical collapse.

EXPLOIT SUCCESS

6-46. Ultimately, only successes that achieve the end state count. To determine how to exploit tactical and operational successes, commanders assess them in terms of the higher commander's intent. An operational design links objectives along lines of operations. However, success will likely occur in ways unanticipated in the plan. Commanders may gain an objective in an unexpected way. Success signals a rapid assessment to answer these questions:

- Does the success generate opportunities that more easily accomplish the objectives?
- Does it suggest other lines of operations?
- Does it cause commanders to change their overall intent?
- Should the force transition to a sequel?
- Should the force accelerate the phasing of the operation?

6-47. Operationally, success may signal a transition to the next phase of the campaign or major operation. Ideally, an appropriate sequel is ready. However, even a prepared sequel requires rapid refinement to reflect the realities of the actual success. Commanders see beyond the requirements of the moment. They employ every available asset to extend their operations in time and space to make the success permanent. Commanders understand that they must maintain momentum and initiative to win rapidly and decisively.

6-48. Exploitation demands assessment and understanding of the impact of sustaining operations. CSS provides the means to exploit success and convert it into decisive results. Sustainment preserves the freedom of action necessary to take advantage of opportunity. Commanders remain fully aware of the status of units and anticipate CSS requirements, recognizing that CSS often determines the depth to which Army forces exploit success.

6-49. Rapid tempo and repeated success always disorganize units to some extent. To exploit success and maintain momentum, reorganization occurs concurrently with other operations rather than as a separate phase. Prolonged reorganization can jeopardize momentum and require committing reserves. Enhanced situational understanding gives commanders an accurate description of unit status and expedites reorganization. Successful reorganization depends on CSS. Force commanders provide timely reorganization guidance and priorities to the CSS commanders. Doing this allows CSS commanders to anticipate requirements and position resources.

COMBINE DECISIVE, SHAPING, AND SUSTAINING OPERATIONS

6-50. During execution, commanders combine and direct decisive, shaping, and sustaining operations. Ideally, the decisive operation occurs approximately as planned. However, opportunity and circumstances often alter the sequence and details of the decisive operation. Commanders create or preserve opportunities through shaping operations. Shaping operations precede and occur concurrently with the decisive operation. Sustaining operations ensure freedom of action to maintain momentum and exploit success.

6-51. Ideally, decisive, shaping, and sustaining operations occur at the same time. Simultaneous operations allow commanders to seize and retain the initiative. However, they require overwhelming combat power and information superiority. Commanders determine if they can accomplish the mission with a single, simultaneous operation; if they cannot, they phase it. In making this decision, they consider the skill and size of the opponent, the size of the area of operations (AO), operational reach, available joint support, and the scope of the mission. The crucial consideration is the success of the decisive operation, which must have enough combat power to conclusively determine the outcome. If that combat power is not available, commanders phase the operation to achieve the maximum possible simultaneous action within each phase.

Maneuver and Fires

6-52. Through maneuver, Army forces seek to defeat the enemy decisively. Maneuver directly engages the enemy center of gravity if feasible; if not, it concentrates against decisive points. Maneuver implies more than the use of fire and movement to secure an objective; it aims at the complete overthrow of the enemy's operational design. It requires audacious concepts and ruthless execution.

6-53. Maneuver avoids those enemy forces best prepared to fight; it engages them at a time or place or in a manner that maximizes relative friendly force advantages. Maneuver creates and exposes enemy vulnerabilities to the massed effects of friendly combat power.

6-54. Operations may include periods of extremely fluid, nonlinear operations, alternating with linear operations (see Figure 6-2, page 6-14). A commander may start an operation with a compact arrangement of forces and quickly transition into nonlinear maneuver against an array of objectives throughout the AO. In different circumstances, the commander might direct multiple attacks in depth to disorganize the enemy and seize key terrain; the attacking force would then consolidate, defend, and prepare to resume the offensive. Another example: A joint land force seizes a lodgment using airborne, air assault, and amphibious operations, while special operations forces attack important facilities distributed across a portion of the AO. The airborne and amphibious units then establish a defense around the lodgment to defend against enemy reaction. When additional forces arrive, the land forces conduct nonlinear operations to end the conflict.

6-55. In some cases, multinational considerations may limit the commander's ability to conduct operations throughout the AO. Multinational partners may lack the information systems, precision attack capabilities, and maneuverability of US forces. Commanders adapt their concept of operations

accordingly, blending multinational and US capabilities. The multinational participants might conduct linear operations, while US Army forces conducted simultaneous nonlinear maneuver in depth. Such an operational design would employ each force according to its capabilities and complement linear operations with nonlinear operations.

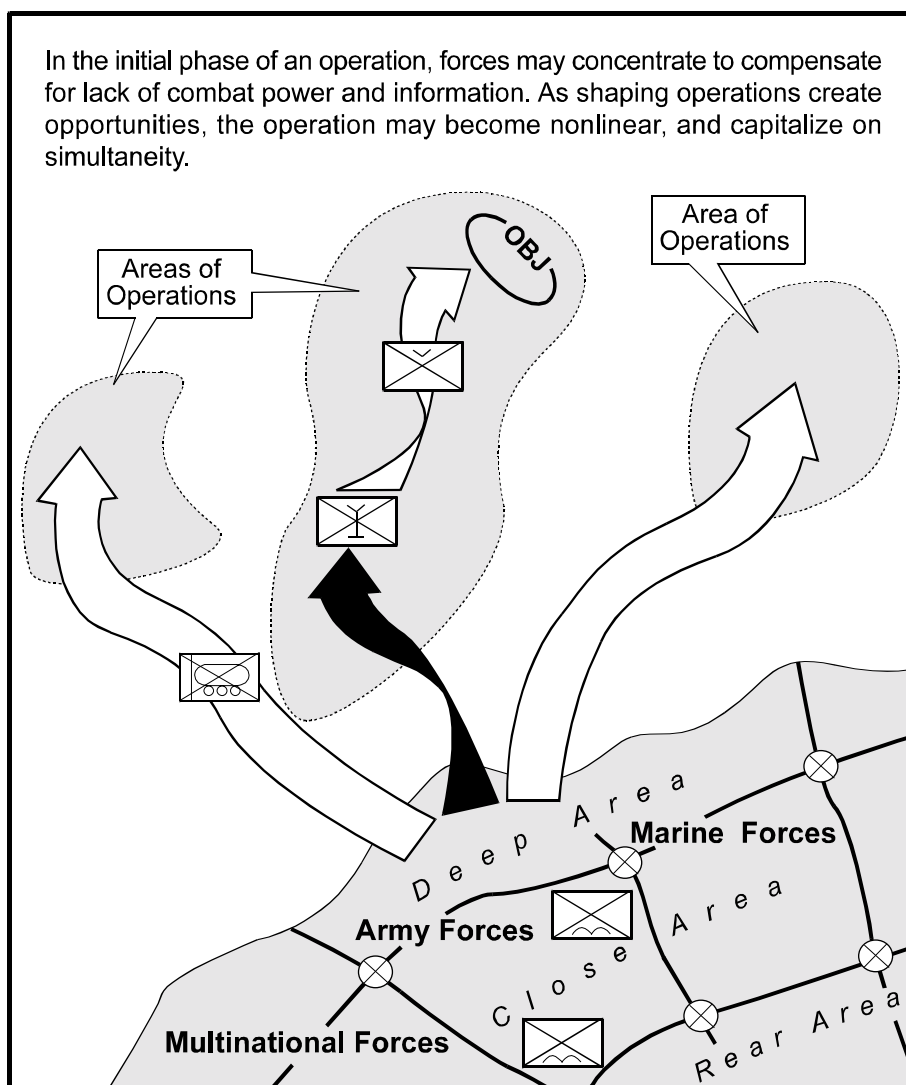

Figure 6-2. Linear and Nonlinear Combinations

6-56. More than ever, precision fires can shape the situation and create conditions for operational and tactical maneuver. Modern weapons are accurate enough for attacks to become very selective. Advanced systems—land, sea, and air—create effects that only complete saturation with fires could achieve in the past. Modern military forces are still assimilating the full consequences of this technological revolution. However, today's weapons allow commanders to avoid lengthy and costly periods of shaping operations to “set the conditions” with fires and other means. Avoiding a lengthy prelude to decisive operations preempts the enemy's chance to seize the initiative.

Commanders determine the appropriate combination of shaping operations needed to ensure success of the decisive operation, recognizing that the effects of fire are transitory.

6-57. The integration of operational fires with operational maneuver requires careful design and effective coordination with the joint force headquarters. Intelligence, surveillance, and reconnaissance (ISR) identify specific enemy capabilities whose loss significantly degrades enemy coherence. Army forces attack the targets with organic lethal and nonlethal means or pass the mission to a supporting joint element. Ideally, the attacks are simultaneous. Simultaneity shocks enemy command and control (C2) systems and often induces paralysis. When the means are insufficient for simultaneous action, commanders plan sequential attacks.

Create Overmatch

6-58. Decisive operations synchronize the BOS to create overmatch at decisive points in the AO. Overmatch is a quantitative or qualitative disparity of such magnitude that the stronger force overwhelms the weaker. Overmatch may apply to one or all of the elements of combat power in combination. Rapid tempo, offensive information operations (IO), and lethal fires combine to disrupt enemy C2 and create a condition of information superiority. Fire support, force protection capabilities, and maneuver neutralize enemy fire support. Supported by indirect and joint fires, maneuver forces close with the enemy and complete his destruction with close combat.

Sustain Combat Power

6-59. Commanders develop a keen understanding of the effects of sustainment on operations. They balance audacity and prudence in terms of CSS and the other BOS. To a significant degree, sustainment determines operational reach and approach. Sustaining operations establish the staying power of Army forces and the depth of operations. They enable commanders to mass the effects of combat power repeatedly and maintain freedom of action.

Use Adaptive Combinations

6-60. As they visualize their battlefield framework and operational design, commanders consider incorporating combinations of contiguous and noncontiguous AOs with linear and nonlinear operations. They choose the combination that fits the situation and the purpose of the operation. Association of contiguous and noncontiguous AOs with linear and nonlinear operations creates the four combinations in Figure 6-3, page 6-16).

6-61. **Linear Operations in Contiguous AOs.** Linear operations in contiguous AOs (upper left in Figure 6-3) typify sustained offensive and defensive operations against powerful, echeloned, and symmetrically organized forces. The contiguous areas and continuous forward line of own troops (FLOT) focus combat power and protect sustaining operations. Commanders normally shape in the deep area, conduct the decisive operation in the close area, and sustain in the rear area.

6-62. **Linear Operations in Noncontiguous AOs.** The upper right box depicts a headquarters with subordinate units conducting linear operations in

noncontiguous AOs. In this case, the higher headquarters retains responsibility for the portion of its AO outside the subordinate unit AOs. The higher headquarters operational design uses nonlinear operations. The subordinate units are conducting linear operations. The subordinate units' battlefield organizations have close, deep, and rear areas; the higher headquarters battlefield organization does not. This combination might be appropriate when the higher headquarters is conducting widely separated simultaneous operations, for example, a vertical envelopment against a decisive point (the decisive operation) from a lodgment (shaping and sustaining operations).

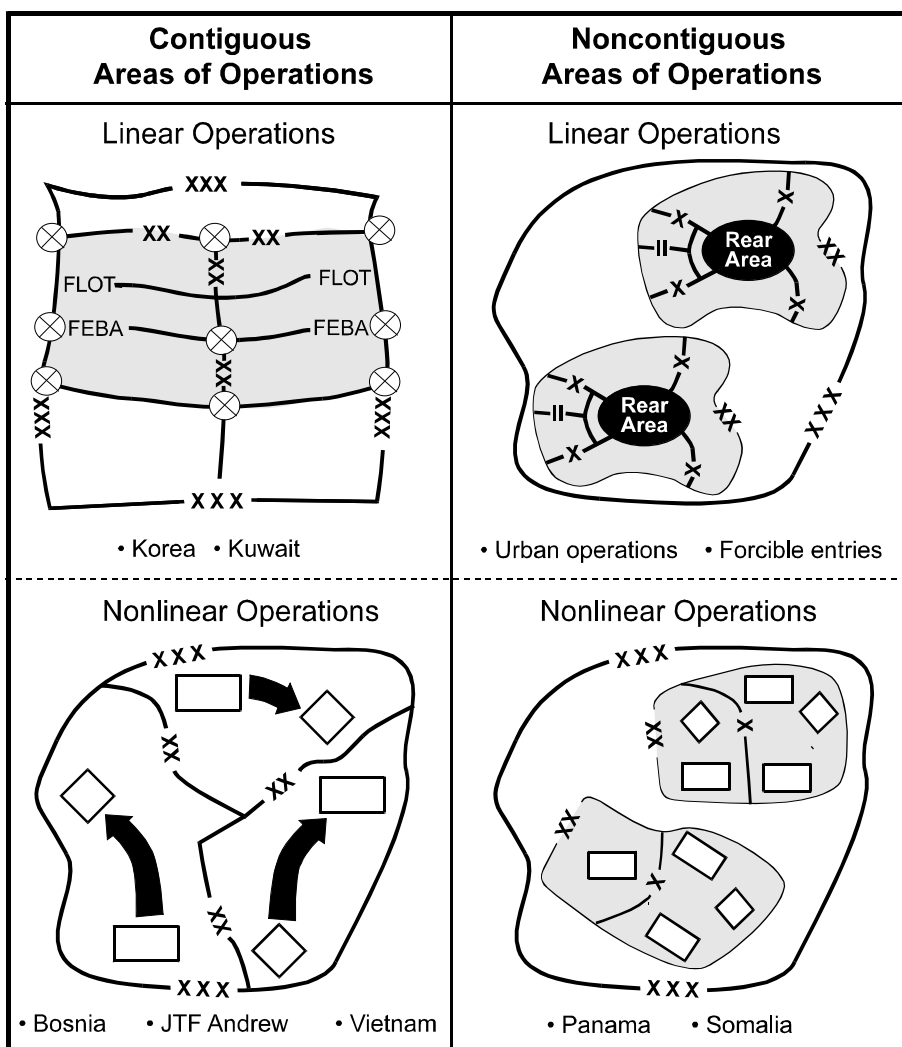

Figure 6-3. Combinations of Contiguous and Noncontiguous Areas of Operations with Linear and Nonlinear Operations

6-63. **Nonlinear Operations in Contiguous AOs.** The lower left box illustrates nonlinear operations being conducted in contiguous AOs. This combination typifies stability operations, such as those in Haiti, Bosnia, and Kosovo. Hurricane Andrew support operations also followed this design. The higher headquarters assigns the responsibility for its entire AO to

subordinate units. Within the subordinate AOs, operations are nonlinear, with the subordinate headquarters receiving support and resources from the higher headquarters. On a tactical scale, search and attack operations are often nonlinear operations conducted in contiguous AOs.

6-64. Nonlinear Operations in Noncontiguous AOs. The lower right box depicts units conducting nonlinear operations in noncontiguous AOs. The operations of both higher and subordinate units are nonlinear. The size of the land AO, composition and distribution of enemy forces, and capabilities of friendly forces are important considerations in deciding whether to use this battlefield organization and operational design. In Somalia in 1992, for example, Army forces conducted nonlinear stability operations and support operations in widely separated AOs around Kismayu and Mogadishu.

COMPLEX OPERATIONAL CONSIDERATIONS

6-65. Army forces execute full spectrum operations in environments that contain complex operational considerations. All operations include challenges. However these complex operational considerations require special attention by commanders and staffs:

- Nuclear, biological, and chemical (NBC) environments.
- Local populace and displaced persons.
- Unconventional threats.
- Urban operations.

Nuclear, Biological, and Chemical Environments

6-66. The threat of WMD profoundly changes theater conditions and imposes major force protection requirements. A major JFC objective is to deter WMD deployment, and if deterrence fails, to find and destroy enemy WMD before they are used. The potential for destruction or contamination of infrastructure by NBC weapons increases the requirement for Army forces that can operate effectively in and around contaminated environments. To a significant degree, the readiness of Army forces to operate in NBC environments deters enemies from using WMD and encourages them to seek solutions that avoid the risk of strategic retaliation.

6-67. Operations in NBC environments demand careful preparation (see JP 3-11; FM 3-11). Vaccines protect soldiers against some biological weapons, but inoculations may need weeks to fully protect recipients. Therefore, protection against these weapons becomes part of the continuous process of keeping units ready. In similar fashion, soldiers may receive medical countermeasures, such as pretreatment before the operation or antidotes during the operation. Medical surveillance programs provide tactical commanders with a tool to develop a baseline of disease threats in the AO. This baseline aids in detecting when the enemy begins biological warfare.

6-68. Units require equipment specifically designed for operations in an NBC environment. Specially trained units may be required to mitigate its effects. NBC operations are CSS-intensive; therefore, sustaining operations require careful planning.

6-69. Commanders at all echelons recognize that the WMD threat is also psychological. Every soldier fears these weapons and has doubts concerning countermeasure and antidote effectiveness. In many cases, the actual threat is less than soldiers imagine, but only realistic individual training will minimize their fear. Training gives soldiers confidence in their equipment and their ability to use it.

6-70. The psychological impact of NBC use goes beyond individual soldiers. Commanders and staffs must be prepared to conduct operations in an NBC environment. Failure to exercise command and staff procedures in scenarios featuring realistic use of NBC weapons can lead to a mentality that NBC hazards present insurmountable obstacles. Only tough command post exercises that force commanders and staffs to work through the problems NBC hazards pose can overcome this attitude. Realistic training demonstrates that NBC hazards, like any other condition, are simply obstacles to overcome.

6-71. Successful US operations may increase the likelihood of enemy WMD use. If the enemy believes that only WMD will retrieve victory, he may resort to using them. Army forces adjust operations accordingly. Rapid maneuver places Army forces near the enemy, compelling him to risk employing WMD on his own forces. Army forces disperse as much as possible and concentrate swiftly, and only as necessary to mass effects. Nonlinear operations position Army forces deep within the enemy AO, complicating his targeting decisions. Precision attacks destroy enemy C2 and CSS systems. Commanders emphasize active and passive force protection. They disperse assembly areas and CSS units. ISR focuses on locating and identifying WMD-capable enemy forces. Reconnaissance units detect and mark hazardous and contaminated areas. Planning also considers US retaliatory or preemptive strikes. Other active measures include theater missile defense, counterair operations, precision fires against enemy WMD systems, and offensive IO.

Local Populace and Displaced Persons

6-72. Army forces create opportunities for success by enlisting the support of the local populace and displaced persons. Frequently, Army forces operate in AOs characterized by chaos and disorder. They may encounter populations with diverse cultures and political orientations that may support, oppose, or remain ambivalent to US presence. In any operation, Army forces will likely encounter displaced civilians or persons of unknown status. Commanders identify these people and design operations with their protection in mind.

6-73. Commanders depend on accurate knowledge of group locations and beliefs to ensure actions taken are consistent with achieving JFC goals and objectives. IO, especially psychological operations, and its related activities (public affairs, and civil-military operations) help commanders influence perceptions and attitudes of the local population. In some operations, IO and its related activities may constitute the decisive operation. The importance of influencing civilians varies, depending on the mission and force objectives.

6-74. The cornerstone of successful action with local populace and displaced persons is discipline. When Army forces operate with the local populace, discipline cements the relationship. In circumstances where the populace is ambivalent or unfriendly, discipline prevents tension from flaring into open

hostility and fosters respect. ROE guide the use of lethal force, not to inhibit action and initiative but to channel it within acceptable limits. The disciplined application of force is more than a moral issue; it is a critical contributor to operational success.

Unconventional Threats

6-75. Commanders protect the force from unconventional threats in four ways. First, they train units and soldiers to protect themselves against terrorist tactics and intrusion. They complement self-defense capabilities by enforcing security policies, such as movement procedures, appropriate to the situation. Second, commanders consider the threat posed by unconventional elements and act to fill gaps in protective capabilities. Actions may include requesting additional combat forces. Third, commanders use all available information resources (including host nation, theater, national, and organic assets) to understand unconventional threats to the force. Commanders at major headquarters may form a national intelligence support team with a total focus on unconventional threats. Finally, by example and constant attention, commanders dispel any sense of complacency toward unconventional threats.

Urban Operations

6-76. **Urban operations include offense, defense, stability, and support operations conducted in a topographical complex and adjacent natural terrain where manmade construction and high population density are the dominant features.** The world is largely urban in terms of population concentration. Army forces conduct urban operations in large, densely populated areas that present distinct problems in clearing enemy forces, restoring services, and managing major concentrations of people. The topography and proximity of noncombatants degrade the effectiveness of technically advanced sensors and weapons. Thus, cities are likely battlegrounds where weaker enemies attempt to negate the advantages Army forces have in more open terrain.

6-77. From a planning perspective, commanders view cities not just as a topographic feature but as dynamic entities that include hostile forces, local population, and infrastructure. Planning for urban operations requires careful IPB, with particular emphasis on the three-dimensional nature of the topography and the intricate social structure of the population. CSS planning accounts for increased consumption, increased threats to lines of communications, and anticipated support to noncombatants. Commanders develop ROE carefully, adapting them to a variety of circumstances, and ensuring soldiers thoroughly understand them.

6-78. Urban operations compress the spatial scale of tactical operations and require combined arms integration at small unit level. Units require careful preparation and thorough rehearsal to master using combined arms techniques in very close quarters. Urban operations place a premium on closely coordinated, combined arms teams and carefully protected CSS. Urban operations are CSS-intensive, demanding large quantities of materiel and support for military forces and noncombatants displaced by operations.

FOLLOW-ON OPERATIONS

6-79. All operations evolve in terms of nature, purpose, and type. Successful operations create new conditions that lead to significant changes in the situation. A new or fundamentally altered center of gravity may emerge. Typically, new conditions initiate sequels.

Transition

6-80. Transitions mark the intervals between the ongoing operation and full execution of branches and sequels. Transitions often mark the change from one dominant type of operations, such as offense, to another such as stability. At lower echelons, transitions occur when one formation passes through another, for example, or when units must breach an obstacle belt. Commanders consider transitions from the current operation to future operations early in the planning process. Command arrangements, for example, often change. Typically, the command structure evolves to meet changing situations. A JTF, for example, may dissolve, and forces revert to their parent components. The operational requirements for Army forces may pass to a new commander, who continues postconflict missions even as some Army forces prepare to redeploy. Frequently, US forces transition from a US-led coalition to a multinational United Nations structure supported by US troops. This occurred at the end of Operation Restore Democracy in Haiti, as US combat forces withdrew.

6-81. Changes in the strategic situation require adjusting the strength and composition of deployed forces. When the dominant type of operation changes—from offense to stability, for example—the types of units originally deployed may no longer be appropriate. As each new force prepares for operations, the JFC and the commander of the Army service component command tailor the Army force to meet mission requirements and theater constraints. The force that initiated the operation may only superficially resemble the force in theater when the operation concludes.

6-82. Transitions are the sequels that occur between types of operations. Commanders anticipate and plan for them as part of any future operation. Transitions between operations are difficult and during execution may create unexpected opportunities for Army forces, enemies, or adversaries. Such opportunities must be recognized quickly, developed as branches to the transition operation, and acted upon immediately. Transition between operations may be the most difficult follow-on operation to accomplish.

Reconstitution

6-83. Prolonged combat or intensive engagements diminish unit combat effectiveness. When a unit is no longer combat effective, commanders consider reconstituting it (see FM 4-100.9). *Reconstitution* consists of those actions that commanders plan and implement to restore units to a desired level of combat effectiveness commensurate with mission requirements and available resources. Reconstitution operations include regeneration and reorganization. *Regeneration* consists of rebuilding a unit through large-scale replacement of personnel, equipment, and supplies. This includes the reestablishment or replacement of essential C2 and training for the newly rebuilt unit.

Reorganization is that action taken to shift internal resources within a degraded unit to increase its level of combat effectiveness.

6-84. The headquarters two echelons up normally controls reconstitution. Commanders and staffs plan reconstitution to fit mission priorities and support the higher commander's intent. The reconstitution plan takes into account follow-on missions. The final decision on whether to reconstitute a depleted unit depends on the situation. Commanders remain flexible. Mission requirements and available resources (including time) determine appropriate reconstitution actions.

6-85. Reconstitution planning is part of course of action development. Units with roles in reconstitution train to perform it. Commanders, staffs, and executing units plan and prepare for reconstitution before they confront it. Any combat, combat support, or CSS unit may require reconstitution. In particular, operations in an NBC environment increase the likelihood that some units will require reconstitution after decontamination.

6-86. Reconstitution requires aggressive application of the tenets of Army operations. Reconstitution actions must regenerate units that allow commanders to continue to set the terms of battle. These actions are necessary to maintain the agility of the force. Quickly recognizing the need for and executing reconstitution help provide the combat effective forces needed to retain the initiative. Commanders visualize reconstitution in terms of depth of time, space, and resources just as they do other operations. They look ahead, consider the resources required and available, and direct the extensive synchronization required.

Conflict Termination

6-87. Conflict termination describes the point at which the principal means of conflict shifts from the use or threat of force to other means of persuasion. Conflict termination may take several forms: for example, the adversary may surrender, withdraw, or negotiate an end to the conflict. Commanders and staffs consider conflict termination requirements when developing campaign plans. If the end state is a situation that promotes economic growth, for example, commanders consider the effects of destroying the economic infrastructure. Regardless of how the conflict ends, it often changes into less violent, but persistent, forms of confrontation.

6-88. Conflict termination is more than the achievement of a military end state: it is the military contribution to broader success criteria. As the policy governing the conflict evolves, so does the end state at both joint and Army levels. Effective campaign plans account for more than military objectives; they specify end states that support national policy. They are also careful to distinguish between the military and other instruments of national power.

6-89. A period of postconflict activities exists between the end of a conflict and redeployment of the last US soldier. Army forces are vital in this period. As a sequel to decisive major operations, Army forces conduct stability operations and support operations to sustain the results achieved by the campaign. These operations ensure that the threat does not resurrect itself and that the conditions that generated the conflict do not recur. Postconflict stability

operations and support operations—conducted by Army forces—transform temporary battlefield successes into lasting strategic results.

ASSESS

6-90. Commanders, assisted by the staff, continuously assess the situation and the progress of the operation, and compare it with the initial vision. **Assessment is the continuous monitoring—throughout planning, preparation, and execution—of the current situation and progress of an operation, and the evaluation of it against criteria of success to make decisions and adjustments.** Commanders direct adjustments to ensure that operations remain aligned with the commander's intent. Subordinates assess their unit's progress by comparing it with the senior commander's intent and adjusting their actions to achieve the envisioned end state, particularly in the absence of orders.

6-91. Assessment precedes and guides every activity within the operations process and concludes each operation or phase of an operation. Assessment entails two distinct tasks: continuously monitoring the situation and the progress of the operation, and evaluating the operation against measures of effectiveness. Together, the two tasks compare reality to expectations.

6-92. Not all operations proceed smoothly toward the desired end state. Commanders examine instances of unexpected success or failure, unanticipated enemy actions, or operations that simply do not go as planned. They assess the causes of success, friction, and failure, and their overall impact on the force and the operation. In assessing the cause of failure or substandard performance, commanders address immediate causes while retaining the intellectual flexibility to look for related or hidden contributors. For example, a commander may replace an ineffective leader after an engagement in which Army forces suffer severe losses. In another instance, the commander may retain subordinate commanders within a defeated force. In both instances, the commander seeks answers to larger questions concerning operations security, enemy doctrine, leadership, equipment, and the state of training of friendly and enemy forces. Commanders also learn from their mistakes and allow subordinates to learn from theirs.

6-93. The American way of war has historically included rapid adaptation to unexpected challenges and situations. A tactical or operational success may prove the worth of a significant technological or procedural innovation. Conversely, Army forces may discover a dangerous vulnerability during the operation. Leaders continuously identify, assess, and disseminate lessons learned throughout the force.

6-94. Formal, postoperational assessments combine the after-action reports prepared by the units involved with the observations compiled by observers. These assessments become the basis for changes to doctrine, training, leader development, organization, and materiel that support soldiers. They typically include interviews with commanders and staffs as well as with small unit leaders and soldiers. Just as commanders encourage and accept initiative on the part of subordinates during the operation, commanders encourage and accept complete candor during the postoperational assessment.

PART THREE

Conducting Decisive Full Spectrum Operations

Part Three discusses the four types of operations—offensive, defensive, stability, and support—that Army forces conduct. It illustrates how to apply the concepts described in Part Two within the operational environment described in Part One.

Chapter 7 discusses offensive operations. The offense is the decisive form of war. The will to seize, retain, and exploit the initiative defines the spirit and purpose of the offense. It is essential to success in all operations—defensive, stability, and support—as well as offensive. Combined with a demonstrated combat capability, it makes Army forces credible in any situation. Circumstances may require defending; however, victory requires shifting to the offense as soon as possible. The offense ends when the force accomplishes the mission, reaches a limit of advance, or approaches culmination. It then consolidates, resumes the attack, or prepares for another operation.

Chapter 8 discusses defensive operations. Commanders direct defensive operations to defeat enemy attacks, buy time, economize forces, or develop conditions favorable for the offense. Although the defense is the stronger form of war, it normally cannot achieve a decision. Thus, commanders simultaneously or sequentially combine defensive operations with offensive operations.

Chapter 9 discusses stability operations. Stability operations include a range of actions that Army forces conduct outside the US and US territories. Their purpose is to promote and sustain regional and global stability. Stability operations are diverse, continuous, and often long-term. However, the credibility and staying power of Army forces allow them to maintain stability until the situation is resolved. Army forces may execute stability operations as part of a theater engagement plan, smaller-scale contingency, or follow-on operation to a campaign or major operation. They are inherently complex and place great demands on leaders, units, and soldiers. Stability operations require the mental and physical agility to shift among situations of peace, conflict, and war and between combat and noncombat operations.

Chapter 10 discusses support operations. Army forces conduct support operations to relieve suffering and help civil authorities prepare for or respond to crises. Support operations are divided into two categories: Domestic support operations are conducted within the US and US territories. Foreign humanitarian assistance is conducted outside the US and US territories. Domestic support operations include civil support—operations to help civil authorities protect US territory, population, and infrastructure against attacks. Other government agencies have primary responsibility for these areas; however, Army forces have specialized capabilities and provide important support. Support operations usually aim to overcome manmade or natural disaster conditions for a limited time until civil authorities no longer need help.

In all environments, the initiative of Army leaders, agility of Army units, depth of Army resources, and versatility of Army soldiers combine to allow Army forces to conduct decisive full spectrum operations. Commanders synchronize offensive, defensive, stability, and support operations to defeat any enemy or dominate any situation—anywhere, anytime.

Chapter 7

Offensive Operations

In war the only sure defense is offense, and the efficiency of the offense depends on the war-like souls of those conducting it.

General George S. Patton Jr.
War as I Knew It

7-1. The offense is the decisive form of war. Offensive operations aim to destroy or defeat an enemy. Their purpose is to impose US will on the enemy and achieve decisive victory. While immediate considerations often require defending, decisive results require shifting to the offense as soon as possible.

PURPOSES OF OFFENSIVE OPERATIONS

7-2. Offensive operations seek to seize, retain, and exploit the initiative to defeat the enemy decisively. Army forces attack simultaneously throughout the area of operations (AO) to throw enemies off balance, overwhelm their capabilities, disrupt their defenses, and ensure their defeat or destruction. The offense ends when the force achieves the purpose of the operation, reaches a limit of advance, or approaches culmination. Army forces conclude a phase of an offensive by consolidating gains, resuming the attack, or preparing for future operations. Additional tasks offensive operations accomplish include—

- Disrupting enemy coherence.
- Securing or seizing terrain.
- Denying the enemy resources.
- Fixing the enemy.
- Gaining information.

OFFENSIVE OPERATIONS AT THE OPERATIONAL AND TACTICAL LEVELS OF WAR

7-3. Army operational commanders conduct offensive campaigns and major operations to achieve theater-level effects based on tactical actions. They concentrate on designing offensive land operations. They determine what objectives will achieve decisive results; where forces will operate; the relationships among subordinate forces in time, space, and purpose; and where to apply the decisive effort. Operational commanders assign AOs to, and establish command and support relationships among, tactical commanders. Tactical

commanders direct offensive operations to achieve objectives—destroying enemy forces or seizing terrain—that produce the theater-level effects operational commanders require.

OPERATIONAL OFFENSE

7-4. At the operational level, offensive operations directly or indirectly attack the enemy center of gravity. Commanders do this by attacking enemy decisive points, either simultaneously or sequentially. Massed effects of joint and multinational forces allow attackers to seize the initiative. They deny the enemy freedom of action, disrupt his sources of strength, and create the conditions for operational and tactical success.

7-5. To attain unity of effort, operational commanders clearly identify objectives and reinforce the relationships among subordinate forces. By minimizing interoperability challenges and harnessing system capabilities, commanders tailor their forces to achieve decisive effects. They allocate sufficient joint and multinational forces to achieve their objectives.

7-6. Tactical commanders exploit the effects that joint and multinational forces contribute to the offense. They synchronize these forces in time, space, resources, purpose, and action to mass the effects of combat power at decisive points. Commanders direct battles as part of major operations. Battles are related in purpose to the operational commander’s objectives.

TACTICAL OFFENSE

7-7. Battles may be linear or nonlinear and conducted in contiguous or non-contiguous AOs. Tactical commanders receive their AO, mission, objectives,

CONTENTS	
Purposes of Offensive Operations	7-2
Offensive Operations at the Operational and Tactical Levels of War	7-2
Operational Offense	7-3
Tactical Offense	7-3
Characteristics of Offensive Operations	7-4
Surprise	7-4
Concentration	7-5
Tempo	7-6
Audacity	7-6
Offensive Operations Within the Operational Framework	7-6
Decisive Operations in the Offense	7-7
Shaping Operations in the Offense	7-8
Sustaining Operations in the Offense	7-10
Considerations for Nonlinear Offensive Operations	7-10
Forms of Maneuver	7-10
Envelopment	7-11
Turning Movement	7-12
Infiltration	7-13
Penetration	7-13
Frontal Attack	7-15
Types of Offensive Operations	7-16
Movement to Contact	7-17
Attack	7-18
Exploitation	7-21
Pursuit	7-22
Conducting Offensive Operations	7-23
Planning Considerations for Offensive Operations	7-23
Preparing for Offensive Operations ..	7-26
Executing Offensive Operations	7-26
The Impact of Technology	7-28

boundaries, control measures, and intent from their higher commander. They determine the decisive, shaping, and sustaining operations within their AO. They direct fires and maneuver to attack and destroy the enemy and attain terrain objectives. Tactical commanders normally have clearly defined tasks—defeat the enemy and occupy the objective.

CHARACTERISTICS OF OFFENSIVE OPERATIONS

7-8. Surprise, concentration, tempo, and audacity characterize the offense. Effective offensive operations capitalize on accurate intelligence and other relevant information regarding enemy forces, weather, and terrain. Commanders maneuver their forces to advantageous positions before contact. Force protection, including defensive information operations (IO), keeps or inhibits the enemy from acquiring accurate information about friendly forces. The enemy only sees what the friendly commander wants him to see. Contact with enemy forces before the decisive operation is deliberate, designed to shape the optimum situation for the decisive operation. The decisive operation is a sudden, shattering action that capitalizes on subordinate initiative and a common operational picture (COP) to expand throughout the AO. Commanders execute violently without hesitation to break the enemy's will or destroy him.

SURPRISE

7-9. In the offense, commanders achieve surprise by attacking the enemy at a time or place he does not expect or in a manner for which he is unprepared. Estimating the enemy commander's intent and denying him the ability to gain thorough and timely situational understanding is necessary to achieve surprise. Unpredictability and boldness help gain surprise. The direction, timing, and force of the attack also help achieve surprise. Surprise delays enemy reactions, overloads and confuses his command and control (C2) systems, induces psychological shock in enemy soldiers and leaders, and reduces the coherence of the defense. By diminishing enemy combat power, surprise enables attackers to exploit enemy paralysis and hesitancy.

7-10. Operational and tactical surprise complement each other. Operational surprise creates the conditions for successful tactical operations. Tactical surprise can cause the enemy to hesitate or misjudge a situation. But tactical surprise is fleeting. Commanders must exploit it before the enemy realizes what is happening.

7-11. Outright surprise is difficult to achieve. Modern surveillance and warning systems, the availability of commercial imagery products, and global commercial news networks make surprise more difficult. Nonetheless, commanders achieve surprise by operating in a way the enemy does not expect. They deceive the enemy as to the nature, timing, objective, and force of an attack. They can use bad weather, seemingly impassable terrain, feints, demonstrations, and false communications to lead the enemy into inaccurate perceptions. Sudden, violent, and unanticipated attacks have a paralyzing effect. Airborne, air assault, and special operations forces (SOF) attacks—combined with strikes by Army and joint fires against objectives the enemy regards as secure—create disconcerting psychological effects on the enemy.

7-12. Surprise can come from an unexpected change in tempo. Tempo may be slow at first, creating the conditions for a later acceleration that catches the enemy off guard and throws him off balance. US forces demonstrated such a rapid change in tempo before Operation Just Cause in 1989. Accelerated tempo resulted in operational and tactical surprise despite increased publicity and heightened tensions beforehand.

7-13. Commanders conceal the concentration of their forces. Units mask activity that might reveal the direction or timing of an attack. Commanders direct action to deceive the enemy and deny his ability to collect information.

Surprise—Coup de Main in Panama

The activity of US forces throughout Panama during 1989 before Operation Just Cause provides an example of achieving strategic surprise. After assuming power in 1984, Manuel Noriega threatened Panamanian democracy and American legal guarantees under the Panama Canal treaties. In response, US forces developed military contingency plans known as Prayer Book and Blue Spoon. In May 1989, Noriega's Dignity Battalions and the Panama Defense Forces increased political pressure on the US to leave Panama by harassing American service members at gunpoint. President George Bush responded by deploying Army and Marine forces during Operation Nimrod Dancer as a show of force. Over the next six months, Army forces conducted Purple Storm and Sand Fleas exercises to reinforce American maneuver rights and gain moral ascendancy over Noriega's forces. Despite the increased US activity, Noriega discounted the possibility of an invasion. On 20 December 1989, SOF conducted the initial assault upon Panama Defense Forces garrisons, airports, media centers, and transportation facilities. Conventional forces soon followed, attacking decisive points throughout Panama. Noriega and his forces were completely surprised. He fled, losing control over his forces as US forces tracked him down.

CONCENTRATION

7-14. Concentration is the massing of overwhelming effects of combat power to achieve a single purpose. Commanders balance the necessity for concentrating forces to mass effects with the need to disperse them to avoid creating lucrative targets. Advances in ground and air mobility, target acquisition, and long-range precision fires enable attackers to rapidly concentrate effects. C2 systems provide reliable relevant information that assists commanders in determining when to concentrate forces to mass effects.

7-15. Attacking commanders manipulate their own and the enemy's force concentration by combining dispersion, concentration, military deception, and attacks. By dispersing, attackers stretch enemy defenses and deny lucrative targets to enemy fires. By massing forces rapidly along converging axes, attackers overwhelm enemy forces at decisive points with concentrated combat power. After a successful attack, commanders keep their forces concentrated to take advantage of their momentum. Should enemy forces threaten them,

they may disperse again. Commanders adopt the posture that best suits the situation, protects the force, and sustains the attack's momentum.

7-16. Concentration requires coordination with other services and multinational partners. At every stage of an attack, commanders integrate joint intelligence assets with joint fires. They capitalize on air superiority to deny the enemy the ability to detect or strike friendly forces from the air. Commanders direct ground, air, and sea resources to delay, disrupt, or destroy enemy reconnaissance elements or capabilities. They also direct security, IO, and counterfire to protect friendly forces as they concentrate.

TEMPO

7-17. Controlling or altering tempo is necessary to retain the initiative. At the operational level, a faster tempo allows attackers to disrupt enemy defensive plans by achieving results quicker than the enemy can respond. At the tactical level, a faster tempo allows attackers to quickly penetrate barriers and defenses and destroy enemy forces in depth before they can react.

7-18. Commanders adjust tempo as tactical situations, combat service support (CSS) necessity, or operational opportunities allow to ensure synchronization and proper coordination, but not at the expense of losing opportunities to defeat the enemy. Rapid tempo demands quick decisions. It denies the enemy the chance to rest and continually creates opportunities.

7-19. By increasing tempo, commanders maintain momentum. They identify the best avenues for attack, plan the action in depth, provide for quick transitions to other operations, and concentrate and combine forces effectively. Commanders and staffs ensure that CSS operations prevent culmination. Once combat begins, attackers execute violently. They follow reconnaissance units or successful probes and quickly move through gaps before defenders recover. Attackers shift combat power quickly to widen penetrations, roll up exposed flanks, and reinforce successes. Friendly forces attack in depth with fires and maneuver to shatter the enemy's coherence and overwhelm his C2. While maintaining a tempo faster than the enemy's, attackers balance the tempo with the ability to exercise C2. Commanders never permit the enemy to recover from the shock of the initial assault. They prevent defenders from massing effects against the friendly decisive operation.

AUDACITY

7-20. Audacity is a simple plan of action, boldly executed. Commanders display audacity by developing bold, inventive plans that produce decisive results. Commanders demonstrate audacity by violently applying combat power. They understand when and where to take risks and do not hesitate as they execute their plan. Commanders dispel uncertainty through action; they compensate for lack of information by seizing the initiative and pressing the fight. Audacity inspires soldiers to overcome adversity and danger.

OFFENSIVE OPERATIONS WITHIN THE OPERATIONAL FRAMEWORK

7-21. Commanders conduct offensive operations within the operational framework (AO, battlespace, and battlefield organization). They synchronize

their forces in time, space, resources, purpose, and action to conduct simultaneous and sequential decisive, shaping, and sustaining operations in depth (see Figure 7-1). In certain situations, commanders designate deep, close, and rear areas.

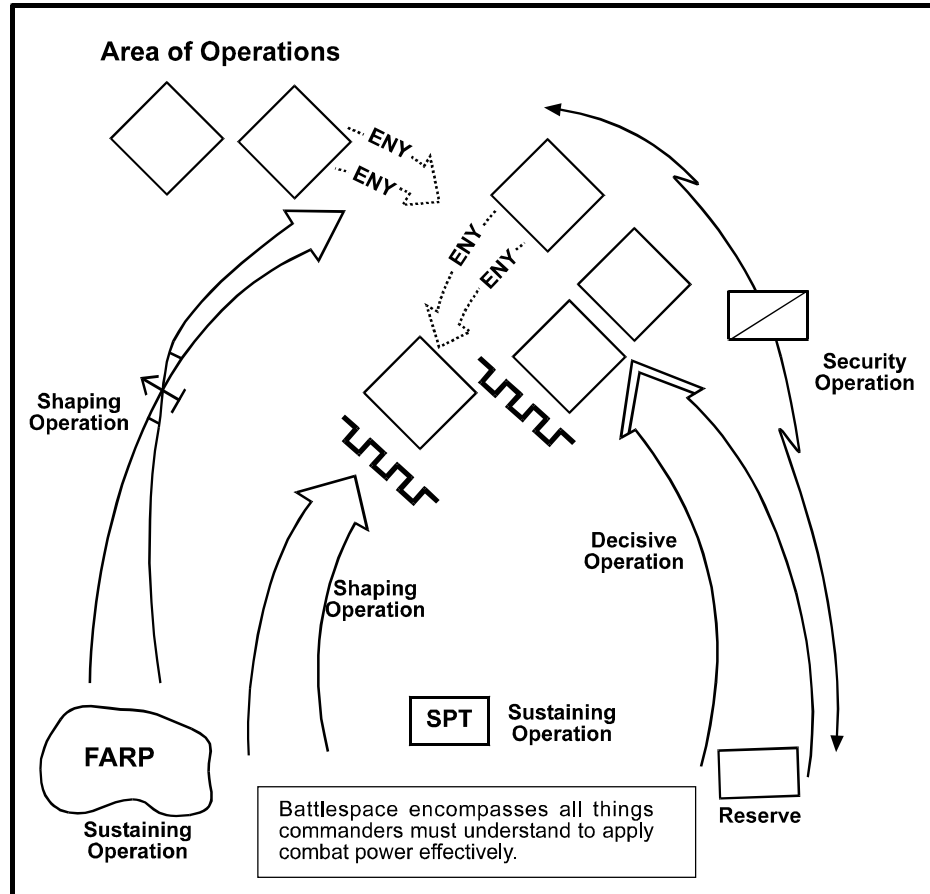

Figure 7-1. Operational Framework in the Offense

DECISIVE OPERATIONS IN THE OFFENSE

7-22. Decisive offensive operations are attacks that conclusively determine the outcome of major operations, battles, and engagements. At the operational level, decisive operations achieve the goals of each phase of a campaign. Ground operations within campaigns may include several phases. Within each phase is a decisive operation. Its results substantially affect the course of the campaign. At the tactical level, decisive battles or engagements achieve the purpose of the higher headquarters mission. Commanders win decisive operations through close combat that physically destroys the enemy; overcomes his will to resist; or seizes, occupies, and retains terrain.

7-23. Commanders weight the decisive operation with additional resources and by skillful maneuver. For example, commanders may fix part of the enemy force with a frontal attack (a shaping operation), while the majority of the force envelops it to seize a decisive point. Commanders decide when,

where, and if to commit additional supporting fires and reserves. Commanders shift priority of fires as necessary. Maneuvering forces positions them to mass fires against the enemy.

7-24. Commanders designate a reserve to provide additional combat power at the decisive time and place. The more uncertain the situation is, the larger the reserve. Once the reserve is committed, the commander designates another. The initial strength and location of reserves vary with—

- Potential missions, branches, and sequels.
- Form of maneuver.
- Possible enemy actions.
- Degree of uncertainty.

Audacity—Turning Movement at Inchon

On 25 June 1950, North Korean forces invaded South Korea. By August, the North Korean People's Army (NKPA) occupied most of the peninsula, with US and Republic of Korea forces confined to a shrinking perimeter behind the Naktong and Nam Rivers. For over a month, both sides engaged in a series of bloody attacks and counterattacks. On 15 September, while United Nations (UN) and North Korean forces were decisively engaged far to the south, X Corps conducted a two-division amphibious landing at Inchon, on the west coast of Korea north of Seoul. This operational turning movement, code-named Operation Chromite, caught the NKPA completely by surprise. Simultaneously, UN aircraft bombarded North Korean forces along the Naktong River to support an Eighth Army counteroffensive. During the following days, American and South Korean Marines pressed toward Seoul. The remainder of X Corps captured the Seoul-Suwon area and severed NKPA supply lines. Army forces soon averaged 10 miles per day over rugged terrain, with the North Korean retreat soon turning into a general rout. By October 1950, the NKPA had dissolved into disorganized remnants fleeing into borderlands adjacent to Manchuria and the Soviet Union.

Reserves provide a hedge against uncertainty. Commanders assign them only those tasks necessary to prepare for their potential mission. Only the commander who designates the reserve can commit it, unless he specifically delegates that authority.

SHAPING OPERATIONS IN THE OFFENSE

7-25. Shaping operations create conditions for the success of the decisive operation. They include attacks in depth to secure advantages for the decisive operation and to protect the force. Commanders conduct shaping operations by engaging enemy forces simultaneously throughout the AO. These attacks deny the enemy freedom of action and disrupt or destroy the coherence and tempo of his operations. Attacking enemy formations in depth destroys, delays, disrupts, or diverts enemy combat power. They may expose or create vulnerabilities for exploitation. Shaping operations in the offense include—

- Shaping attacks designed to achieve one or more of the following:

- Deceive the enemy.
- Destroy or fix enemy forces that could interfere with the decisive operation.
- Control terrain whose occupation by the enemy would hinder the decisive operation.
- Force the enemy to commit reserves prematurely or into an indecisive area.
- Reconnaissance and security operations.
- Passages of lines.
- Breaching operations.
- Unit movements that directly facilitate shaping and decisive operations.
- Operations by reserve forces before their commitment.
- Interdiction by ground and air movement and fires, singularly or in combination.
- Offensive IO.

Other shaping operations include activities in depth, such as counterfire and defensive IO. These shaping operations focus on effects that create the conditions for successful decisive operations.

Desert Storm—A Decisive Offensive Operation

On 24 February 1991, after a 38-day major shaping operation by the US Central Command air component with land component support, Army forces began one of the most decisive land combat operations of modern warfare. Army forces attacked Iraqi forces as part of a coalition offensive, XVIII Airborne Corps in the west with VII Corps on its right flank. First (Tiger) Brigade, 2d Armored Division, attacked as part of the 1st Marine Expeditionary Force in the east. Army forces quickly penetrated Iraqi defenses, rapidly seizing their objectives. Soldiers used advanced technology that allowed vehicle and air crews to acquire and engage targets from beyond the range of Iraqi weapons systems. The shock effect of armor and well-trained infantry—coupled with overwhelming fire support and responsive combat support and CSS—shattered the Iraqi army. XVIII Airborne Corps drove 100 miles north and 70 miles east into Iraq; VII Corps moved 100 miles north and 55 miles east. Coalition forces destroyed 3,800 of 4,200 tanks, over half the personnel carriers, and nearly all of the 3,000 artillery pieces belonging to the Iraqi Army. Coalition forces captured over 60,000 prisoners. After 100 hours of combat, only 7 of 43 Iraqi divisions remained combat effective. The coalition had crushed the fourth largest army in the world and liberated Kuwait.

7-26. The advance, flank, or rear security forces conduct security operations (see FM 3-90). These elements—

- Provide early warning.
- Find gaps in defenses.
- Provide time to react and space to maneuver.

- Develop the situation.
- Orient on the force or facility to be secured.
- Perform continuous reconnaissance.
- Maintain enemy contact.

In extended and noncontiguous AOs, commanders secure or conduct surveillance of the gaps between subordinate units. Commanders secure gaps by assigning a force to secure the area, dedicating surveillance efforts to monitor it, designating a force to respond to an approaching enemy, or by installing and overwatching obstacles.

SUSTAINING OPERATIONS IN THE OFFENSE

7-27. Sustaining operations in the offense ensure freedom of action and maintain momentum. They occur throughout the AO. CSS unit locations need not be contiguous with those of their supported forces. An extended major operation may place tactical units far from the original support area. Commanders may separate attacking forces from the CSS base, thus extending their lines of communication (LOCs). Commanders provide security to CSS units when operating with extended LOCs.

CONSIDERATIONS FOR NONLINEAR OFFENSIVE OPERATIONS

7-28. Nonlinear offensive operations can occur in both contiguous and noncontiguous AOs. The size of an AO is normally very large compared to the number of soldiers deployed. The AO may also encompass diverse terrain. Enemy forces will be widely dispersed and may be numerically superior. Attacking forces must focus offensive actions against decisive points, while allocating the minimum essential combat power to shaping operations. Reserves must have a high degree of tactical mobility. Forces conducting nonlinear operations require robust communications and sustainment capabilities. Commanders may dedicate forces for LOC security operations beyond that provided by available military police.

7-29. The higher headquarters conducts security operations in those portions of the AO not allocated to subordinates. Flank security importance increases as operations extend and attacking forces expose their flanks. Linkup operations often occur in this environment. Linkup operations, particularly those involving vertical envelopments, require extensive planning and rehearsal. The potential for fratricide increases due to the fluid nature of the nonlinear battlefield and the changing disposition of attacking and defending forces. The presence of noncombatants in the AO further complicates operations. In this setting, commanders exercise prudent judgment in clearing fires, both direct and indirect.

FORMS OF MANEUVER

7-30. The five forms of maneuver are the envelopment, turning movement, infiltration, penetration, and frontal attack. While normally combined, each form of maneuver attacks the enemy differently. Each poses different challenges for attackers and different dangers for defenders. Commanders determine the form of maneuver to use by analyzing the factors of METT-TC.

ENVELOPMENT

7-31. The *envelopment* is a form of maneuver in which an attacking force seeks to avoid the principal enemy defenses by seizing objectives to the enemy rear to destroy the enemy in his current positions. At the tactical level, envelopments focus on seizing terrain, destroying specific enemy forces, and interdicting enemy withdrawal routes (see Figure 7-2). Envelopments avoid the enemy front, where he is protected and can easily concentrate fires. Single envelopments maneuver against one enemy flank; double envelopments maneuver against both. Either variant can develop into an encirclement.

7-32. To envelop the enemy, commanders find or create an assailable flank. Sometimes the enemy exposes a flank by advancing, unaware of friendly locations. In other conditions, such as a fluid battle involving forces in noncontiguous AOs, a combination of air and indirect fires may create an assailable flank by isolating the enemy on unfavorable terrain.

7-33. Attackers may also create an assailable flank by arriving from an unexpected direction. A vertical envelopment (an air assault or airborne operation) is an example of such a shaping operation. Attackers may also fix defenders' attention forward through a combination of fires and shaping or diversionary attacks. Attackers maneuver against the enemy's flanks and rear and concentrate combat power on his vulnerabilities before he can reorient his defense.

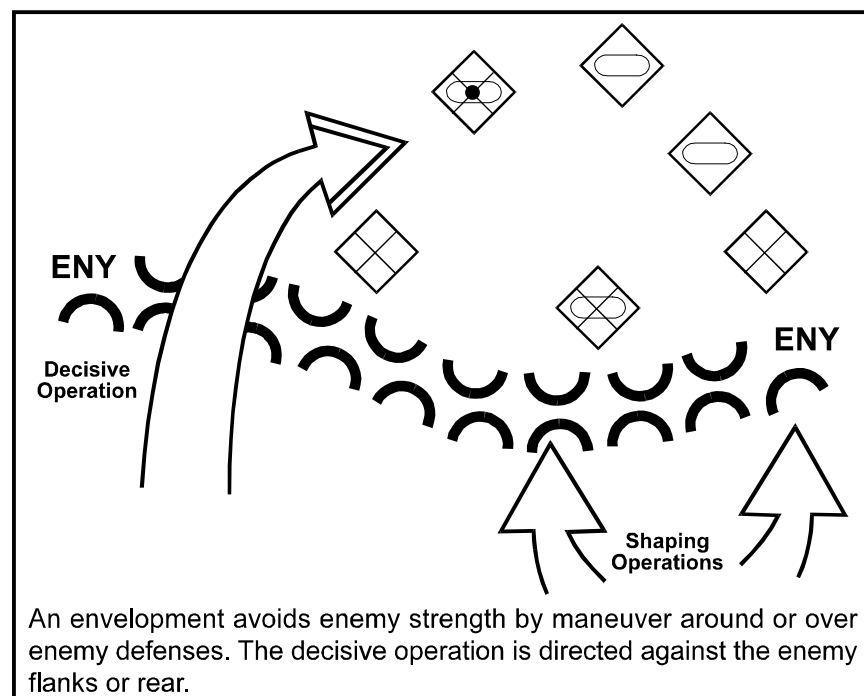

Figure 7-2. Envelopment

7-34. An envelopment may result in an encirclement. *Encirclements* are operations where one force loses its freedom of maneuver because an opposing force is able to isolate it by controlling all ground lines of

communications. An offensive encirclement is typically an extension of either a pursuit or envelopment. A direct pressure force maintains contact with the enemy, preventing his disengagement and reconstitution. Meanwhile, an encircling force maneuvers to envelop the enemy, cutting his escape routes and setting inner and outer rings. The outer ring defeats enemy attempts to break through to his encircled force. The inner ring contains the encircled force. If necessary, the encircling force organizes a hasty defense along the enemy escape route, while synchronizing joint or multinational fires to complete his destruction. All available means, including obstacles, should be used to contain the enemy. Then friendly forces use all available fires to destroy him. Encirclements often occur in nonlinear offensive operations.

TURNING MOVEMENT

7-35. A **turning movement** is a form of maneuver in which the attacking force seeks to avoid the enemy's principal defensive positions by seizing objectives to the enemy rear and causing the enemy to move out of his current positions or divert major forces to meet the threat (see Figure 7-3). A major threat to his rear forces the enemy to attack or withdraw rearward, thus "turning" him out of his defensive positions. Turning movements typically require greater depth than other forms of maneuver. Deep fires take on added importance. They protect the enveloping force and attack the enemy. Operation Chromite, the amphibious assault at Inchon during the Korean War, was a classic turning movement that achieved both strategic and operational effects.

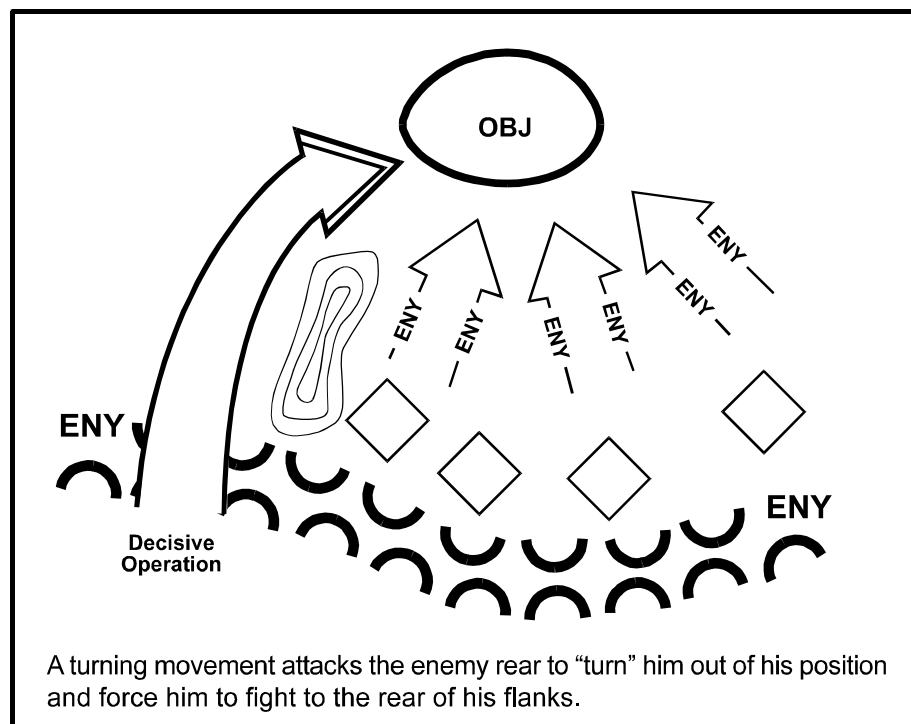

Figure 7-3. Turning Movement

INFILTRATION

7-36. An *infiltration* is a form of maneuver in which an attacking force conducts undetected movement through or into an area occupied by enemy forces to occupy a position of advantage in the enemy rear while exposing only small elements to enemy defensive fires (see Figure 7-4). The need to avoid being detected and engaged may limit the size and strength of infiltrating forces. Infiltration rarely defeats a defense by itself. Commanders direct infiltrations to attack lightly defended positions or stronger positions from the flank and rear, to secure key terrain to support the decisive operation, or to disrupt enemy sustaining operations. Typically, forces infiltrate in small groups and reassemble to continue their mission.

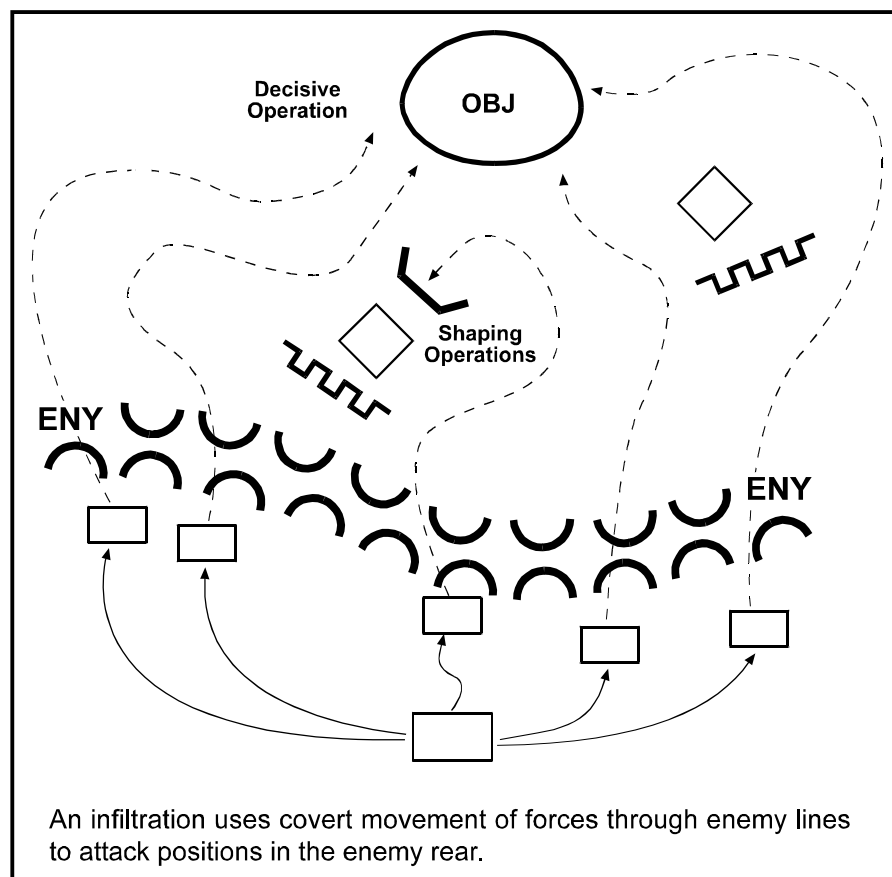

Figure 7-4. Infiltration

PENETRATION

7-37. A *penetration* is a form of maneuver in which an attacking force seeks to rupture enemy defenses on a narrow front to disrupt the defensive system (see Figure 7-5, page 7-14). Commanders direct penetrations when enemy flanks are not assailable or time does not permit another form of maneuver. Successful penetrations create assailable flanks and provide access to enemy rear areas. Because penetrations frequently are directed into the front of the enemy defense, they risk significantly more friendly casualties than envelopments, turning movements, and infiltrations.

7-38. Swift concentration and audacity are particularly important during a penetration. Commanders mass effects from all available fires at the point of penetration to make the initial breach. Then they widen the penetration by enveloping enemy units on its shoulders and pass forces through to secure objectives in the enemy rear or defeat the penetrated enemy forces in detail. Forces making the initial breach move rapidly to avoid enemy counterattacks to their flanks. Follow-on forces secure the shoulders and widen the breach. Throughout all phases, fires in depth target enemy indirect fire assets, units along the shoulders of the penetration, and counterattack forces. Other friendly forces fix enemy forces that can move against the penetration with attacks, fires, feints, and demonstrations.

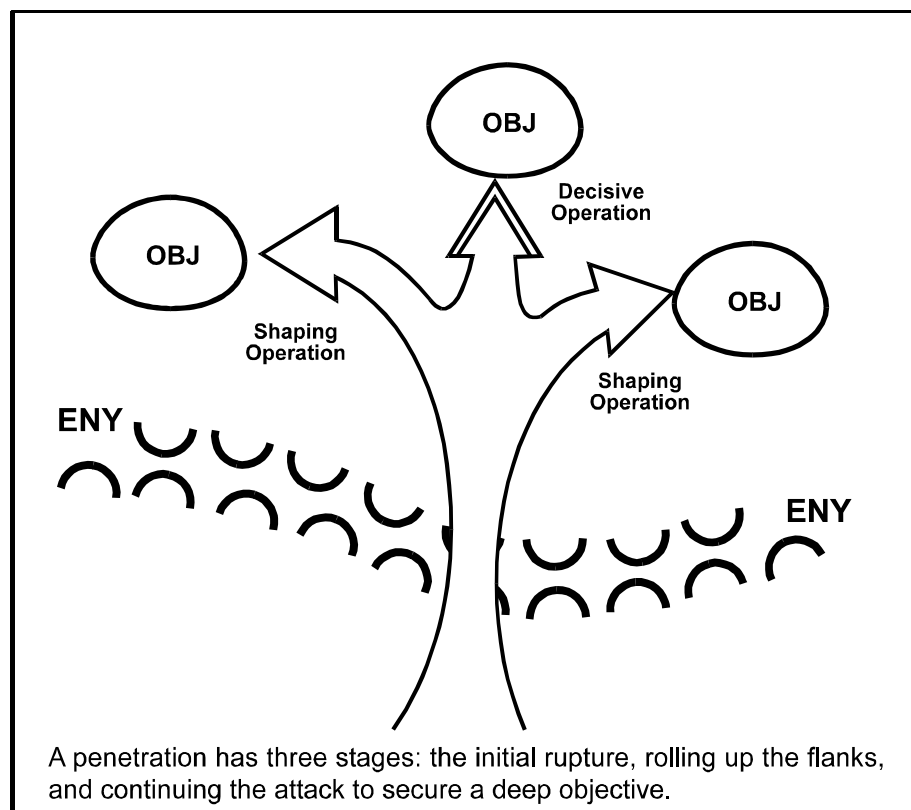

Figure 7-5. Penetration

7-39. If sufficient combat power is available, operational commanders may direct multiple penetrations. Commanders carefully weigh the advantage of such attacks. Multiple penetrations force the enemy to disperse his fires and consider multiple threats before committing his reserves. Commanders then decide how to sustain and exploit multiple penetrations and whether penetrating forces converge on one deep objective or attack multiple objectives. At the tactical level, there is normally insufficient combat power to conduct more than one penetration.

FRONTAL ATTACK

7-40. A **frontal attack** is a form of maneuver in which an attacking force seeks to destroy a weaker enemy force or fix a larger enemy force in place over a broad front (see Figure 7-6). At the tactical level, an attacking force can use a frontal attack to rapidly overrun a weaker enemy force. A frontal attack strikes the enemy across a wide front and over the most direct approaches. Commanders normally use it when they possess overwhelming combat power and the enemy is at a clear disadvantage. Commanders mass the effects of direct and indirect fires, shifting indirect and aerial fires just before the assault. Success depends on achieving an advantage in combat power throughout the attack.

7-41. The frontal attack is frequently the most costly form of maneuver, since it exposes the majority of the attackers to the concentrated fires of the defenders. As the most direct form of maneuver, however, the frontal attack is useful for overwhelming light defenses, covering forces, or disorganized enemy resistance. It is often the best form of maneuver for hasty attacks and meeting engagements, where speed and simplicity are essential to maintain tempo and the initiative. Commanders may direct a frontal attack as a shaping operation and another form of maneuver as the decisive operation. Commanders may also use the frontal attack during an exploitation or pursuit. Commanders of large formations conducting envelopments or penetrations may direct subordinate elements to conduct frontal attacks as either shaping operations or the decisive operation.

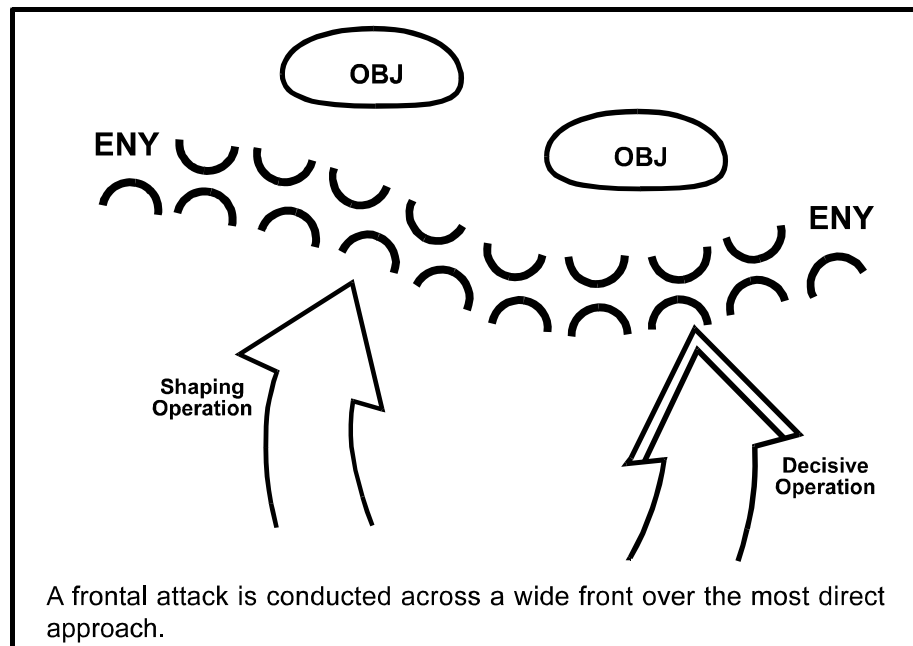

Figure 7-6. Frontal Attack

TYPES OF OFFENSIVE OPERATIONS

7-42. The four types of offensive operations are movement to contact, attack, exploitation, and pursuit. Commanders direct these offensive operations sequentially and in combination to generate maximum combat power and destroy the enemy. For instance, a successful attack may lead to an exploitation, which can lead to a pursuit. A deliberate attack to complete the enemy's destruction can follow a pursuit. In other cases, commanders may direct an attack against the enemy during a pursuit to slow his withdrawal.

7-43. Commanders combine and sequence movements to contact, attacks, exploitations, and pursuits to gain the greatest advantage. Attacks do not always lead to exploitations and pursuits. For example, spoiling attacks, feints, and demonstrations rarely develop into exploitations; however, circumstances may allow commanders to exploit an unexpected success with a full-scale attack.

7-44. Commanders recognize that the many types of offensive and defensive operations may run together with no discernible break. They employ spoiling attacks while defending to slow the enemy tempo until they are ready to attack. As they prepare to transition from one offensive operation to another, or from offense to defense, commanders can conduct a feint in one area to divert enemy attention from operations elsewhere.

7-45. A form of troop movement often precedes an offensive operation. The three forms of troop movement are administrative movement, tactical road march, and approach march.

- An *administrative movement* is a movement in which troops and vehicles are arranged to expedite their movement and conserve time and energy when no enemy interference, except by air, is anticipated. Administrative movements occur in areas where enemy forces do not pose an immediate threat to operations and heightened security is not necessary.
- A **tactical road march** is a rapid movement used to relocate units within an area of operations to prepare for combat operations. Although contact with enemy forces is not anticipated, security against air attack, enemy SOF, and sympathizers is maintained and the unit is prepared to take immediate action against an enemy threat. Tactical road marches occur when a force must maintain security or when movements occur within range of enemy influence. Commanders may still execute tactical road marches in low-threat environments to maintain C2 and meet specific movement schedules.
- An **approach march** is the advance of a combat unit when direct contact with the enemy is intended. Soldiers are fully or partially deployed. Commanders direct an approach march when they are relatively certain of the enemy location and are a considerable distance from it. They decide where their forces can deploy into attack formations that facilitate the initial contact and still provide freedom of action for the bulk of their forces. In contiguous AOs, a passage of lines often precedes or follows an approach march.

MOVEMENT TO CONTACT

7-46. The ***movement to contact*** is a type of offensive operation designed to develop the situation and establish or regain contact. Forces conducting a movement to contact seek to make contact with the smallest force feasible. On contact, the commander has five options: attack, defend, bypass, delay, or withdraw.

7-47. A successful movement to contact requires units with sufficient mobility, agility, and combat power to gain enemy contact and rapidly develop the situation. Six fundamentals apply:

- Focus all efforts on finding the enemy.
- Make initial contact with the smallest element possible, consistent with protecting the force.
- Make initial contact with small, mobile, self-contained forces to avoid decisive engagement of the main body on ground chosen by the enemy. Doing this allows the commander maximum flexibility to develop the situation.
- Task organize the force and use movement formations to deploy and attack rapidly in any direction.
- Keep forces postured within supporting distances to facilitate a flexible response.
- Maintain contact once gained.

7-48. Commanders organize forces to provide all-around security. This normally requires advance, flank, and rear guards. They lead with a combined arms security force to locate and fix the enemy. Corps and divisions normally organize a powerful, self-contained covering force to do this. Smaller formations organize security forces within the limits of their resources. Commanders employ the security force far enough ahead of the main body to provide enough time and space to react to enemy contact. Guard formations remain within supporting range of the main body. Advance and flank guards perform continuous reconnaissance to the front and flanks of the main body. They destroy or suppress small enemy forces so they cannot threaten the main body. The advance guard moves as fast and as far ahead of the main body as possible without moving beyond supporting range. The main body provides the advance guard, normally organized as a separate element. Main body units normally provide and control flank and rear security forces.

Supporting distance is the distance between two units that can be traveled in time for one to come to the aid of the other. For small units, it is the distance between two units that can be covered effectively by their fires.

Supporting range is the distance one unit may be geographically separated from a second unit, yet remain within the maximum range of the second unit's indirect fire weapons systems.

7-49. Security forces remain oriented on the main body, taking into account enemy capabilities and the terrain. They bypass or breach obstacles in stride.

Commanders decentralize movement authority to leaders on the front and flanks. Normally, commanders should position themselves well forward during movements to contact.

Search and Attack

7-50. ***Search and attack is a technique for conducting a movement to contact that shares many of the characteristics of an area security mission.*** Light and medium maneuver units, attack aviation, air cavalry, and air assault units normally conduct them. The purpose of a search and attack operation is to destroy enemy forces, protect the friendly force, deny an area to the enemy, or collect information. Commanders direct search and attack when the enemy disperses in close terrain unsuited for heavy forces, when they cannot find enemy weaknesses, or when they want to deny the enemy movement in an area. They also direct search and attack against enemy infiltrators or SOF operating in a given area. Search and attack is useful in area security missions, such as clearing AOs.

Meeting Engagement

7-51. A ***meeting engagement is a combat action that occurs when a moving force engages an enemy at an unexpected time and place.*** Such encounters normally occur by chance in small unit operations, typically when two moving forces collide. They may result in brigade or larger unit operations when intelligence, surveillance, and reconnaissance (ISR) operations have been ineffective. Meeting engagements can also occur when opposing forces are aware of the general presence but not the exact location of each other and both decide to attack immediately. On contact, commanders quickly act to gain the advantage. Speed of action and movement, coupled with both direct and indirect fires, are essential. To maintain momentum, lead elements quickly bypass or fight through light resistance. Freedom to maneuver is always advantageous; however, commanders may choose to establish a hasty defense if the enemy force is larger or the terrain offers a significant benefit.

7-52. The initiative and audacity of small unit leaders are essential for the friendly force to act faster than the enemy. Commanders balance focusing combat power rapidly with keeping other options open and maintaining pressure on the enemy. In meeting engagements, the force that gains and retains the initiative wins. Commanders seize and maintain the initiative through battle command: rapidly visualizing the situation, deciding what to do, and directing forces to destroy enemy combat power. A successful meeting engagement fixes or reduces the enemy force with maneuver and massed, overwhelming fires—both direct and indirect—while the friendly force bypasses or attacks it.

ATTACK

7-53. An ***attack is an offensive operation that destroys or defeats enemy forces, seizes and secures terrain, or both.*** Attacks incorporate coordinated movement supported by direct and indirect fires. They may be either decisive or shaping operations. Attacks may be hasty or deliberate, depending on the time available for assessing the situation, planning, and preparing. Commanders execute hasty attacks when the situation calls for

immediate action with available forces and minimal preparation. They conduct deliberate attacks when there is time to develop plans and coordinate preparations (see FM 3-90). The same fundamentals of the offense apply to each type of attack. Success depends on skillfully massing the effects of combat power.

Types of Attack

- Hasty
- Deliberate
- Special Purpose
 - Spoiling
 - Counterattack
 - Raid
 - Ambush
 - Feint
 - Demonstration

Hasty Attack

7-54. Commanders direct hasty attacks to seize opportunities to destroy the enemy or seize the initiative. These opportunities are fleeting. They usually occur during movements to contact and defensive operations. In a hasty attack, commanders intentionally trade the advantages of thorough preparation and full synchronization for those of immediate execution. In a movement to contact, commanders launch hasty attacks to destroy enemy forces before they concentrate or establish a defense. In the defense, commanders direct hasty attacks to destroy an exposed or overextended attacker. On-order and be-prepared missions allow units to respond quickly in uncertain situations.

7-55. Once they decide to attack, commanders execute as quickly as possible. While hasty attacks maximize the effects of agility and surprise, they incur the risk of losing some synchronization. To minimize this risk, commanders make maximum use of standing operating procedures (SOPs) that include standard formations and well-understood and rehearsed battle drills. Supporting arms and services organize and position themselves to react quickly, using prearranged procedures. Habitual relationships among supported and supporting units at all echelons facilitate these actions.

Deliberate Attack

7-56. In contrast to hasty attacks, deliberate attacks are highly synchronized operations characterized by detailed planning and preparation. Deliberate attacks use simultaneous operations throughout the AO, planned fires, shaping operations, and forward positioning of resources needed to sustain momentum. Commanders take the time necessary to position forces and develop sufficient intelligence to strike the enemy with bold maneuver and accurate, annihilating fires. Because of the time required to plan and prepare deliberate attacks, commanders often begin them from a defensive posture. However, an uncommitted force may conduct a deliberate attack as a sequel to an ongoing offensive operation.

7-57. Time spent preparing a deliberate attack may allow the enemy to improve defenses, retire, or launch a spoiling attack. Therefore, commanders direct deliberate attacks only when the enemy cannot be bypassed or overcome with a hasty attack. Commanders maintain pressure on the enemy while they plan and prepare. They aggressively disrupt enemy defensive preparations through aggressive patrolling, feints, limited-objective attacks, harassing indirect fires, air strikes, and offensive IO.

7-58. Deliberate attacks require extensive planning and coordination, to include positioning reserves and follow-on forces while preparing troops and

equipment. Commanders and staffs refine plans based on rehearsals and intelligence from reconnaissance and surveillance. Commanders conduct IO to deceive the enemy and prevent him from exercising effective C2. Effective IO mask attack preparations and conceal friendly intentions and capabilities. Commanders direct reconnaissance and surveillance missions to collect information about the enemy and AO. The intelligence system analyzes this information to find weaknesses in enemy capabilities, dispositions, or plans. Friendly forces exploit enemy weaknesses before and during the attack. Effective information management (IM) routes data collected by reconnaissance and surveillance assets to the right place for analysis. IM also facilitates rapid dissemination of intelligence products to forces that need them.

Special Purpose Attacks

7-59. Certain forms of attack employ distinctive methods and require special planning. Commanders direct these special purpose attacks to achieve objectives different from those of other attacks. Spoiling attacks and counterattacks are usually phases of a larger operation. Raids and ambushes are generally single-phased operations conducted by small units. Feints and demonstrations are military deception operations.

7-60. Spoiling Attack. A *spoiling attack* is a form of attack that preempts or seriously impairs an enemy attack while the enemy is in the process of planning or preparing to attack. Normally conducted from a defensive posture, spoiling attacks strike where and when the enemy is most vulnerable—during preparations for attack in assembly areas and attack positions or while he is moving toward his line of departure. Therefore, proper timing and coordinating with higher headquarters are critical requirements for them. Spoiling attacks are highly dependent on accurate information on enemy dispositions. Commanders are alert for opportunities to exploit advantages created by a spoiling attack.

7-61. Counterattack. A *counterattack* is a form of attack by part or all of a defending force against an enemy attacking force with the general objective of denying the enemy his goal in attacking. Commanders normally conduct counterattacks from a defensive posture; they direct them to defeat or destroy enemy forces or to regain control of terrain and facilities after enemy successes. Commanders direct counterattacks with reserves, lightly committed forward elements, or specifically assigned forces. They counterattack after the enemy launches an attack, reveals his main effort, or offers an assailable flank.

7-62. Commanders conduct counterattacks much like other operations, synchronizing them within the overall effort. When possible, units rehearse and prepare the ground. Counterattacking forces may conduct local exploitations to take advantage of tactical opportunities, but then usually resume a defensive posture. Large-unit headquarters preplan counterattacks as major exploitations and pursuits. In those cases, a counterattack may be the first step in seizing the initiative and transitioning to offensive operations. A counterattack is the decisive operation in a mobile defense.

7-63. Raid. A raid is a form of attack, usually small scale, involving a swift entry into hostile territory to secure information, confuse the enemy, or

destroy installations. It usually ends with a planned withdrawal from the objective area upon mission completion. Raids have narrowly defined purposes. They require both detailed intelligence and deliberate planning. Raids may destroy key enemy installations and facilities, capture or free prisoners, or disrupt enemy C2 or other important systems.

7-64. **Ambush.** An *ambush* is a form of attack by fire or other destructive means from concealed positions on a moving or temporarily halted enemy. An ambush destroys enemy forces by maximizing the element of surprise. Ambushes can employ direct fire systems or other destructive means, such as command-detonated mines, nonlethal fires, and indirect fires. Ambushes can disrupt enemy cohesion, sense of security, and confidence. They are particularly effective against enemy sustaining operations.

7-65. **Feint.** A *feint* is a form of attack used to deceive the enemy as to the location or time of the actual decisive operation. Forces conducting a feint seek direct fire contact with the enemy but avoid decisive engagement. Feints divert attention from the decisive operation and prevent the enemy from focusing combat power against it. They are usually shallow, limited-objective attacks conducted before or during the decisive operation. During Operation Desert Storm, units of the 1st Cavalry Division conducted feints in the Ruqi pocket before 24 February 1991. The purpose of these feints was to fix Iraqi frontline units and convince Iraqi commanders that the coalition decisive operation would occur along the Wadi al-Batin.

7-66. **Demonstration.** A *demonstration* is a form of attack designed to deceive the enemy as to the location or time of the decisive operation by a display of force. Forces conducting a demonstration do not seek contact with the enemy. Demonstrations are also shaping operations. They seek to mislead the enemy concerning the attacker's true intentions. They facilitate decisive operations by fixing the enemy or diverting his attention from the decisive operation. Commanders allow the enemy to detect a demonstration. However, doing this without revealing the demonstration's true purpose requires skill. If a demonstration reveals an enemy weakness, commanders may follow it with another form of attack.

EXPLOITATION

7-67. An exploitation is a type of offensive operation that usually follows a successful attack and is designed to disorganize the enemy in depth. Exploitations seek to disintegrate enemy forces to the point where they have no alternative but surrender or flight. Commanders of exploiting forces receive the greatest possible latitude to accomplish their missions. They act with great aggressiveness, initiative, and boldness. Exploitations may be local or major. Local exploitations take advantage of tactical opportunities, foreseen or unforeseen. Division and higher headquarters normally plan major exploitations as branches or sequels.

7-68. Attacks that completely destroy a defender are rare. More often, the enemy attempts to disengage, withdraw, and reconstitute an effective defense as rapidly as possible. In large-scale operations, the enemy may attempt to mass combat power against an attack by moving forces from less active areas

or committing reserves. During exploitations, commanders execute simultaneous attacks throughout the AO to thwart these enemy actions.

7-69. During attacks, commanders remain alert to opportunities for exploitation. Indicators include—

- Large numbers of prisoners and the surrender of entire enemy units.
- Enemy units disintegrating after initial contact.
- A lack of an organized defense.
- The capture or absence of enemy leaders.

7-70. Commanders plan to exploit every attack unless restricted by higher headquarters or exceptional circumstances. Exploitation pressures the enemy, compounds his disorganization, and erodes his will to resist. Upon shattering enemy coherence, attacking forces strike targets that defeat enemy attempts to regroup. Attackers swiftly attack command posts, sever escape routes, and strike enemy reserves, field artillery, and critical combat support and CSS assets.

7-71. Opportunities for local exploitations may emerge when the main effort is elsewhere in the AO. Commanders vary tempos among subordinate commands to take advantage of these opportunities while continuing to press the main effort. Simultaneous local exploitations at lower echelons can lead to a major exploitation that becomes the decisive operation.

7-72. Exploiting success is especially important after a deliberate attack in which the commander accepted risk elsewhere to concentrate combat power for the decisive operation. Failure to exploit aggressively the success of the decisive operation may allow the enemy to detect and exploit a friendly weakness and regain the initiative.

7-73. When possible, lead forces transition directly into an exploitation. If that is not feasible, commanders pass fresh forces into the lead. Exploitations require the physical and mental aggressiveness to combat the friction of night, bad weather, possible fratricide, and extended operations.

7-74. Successful exploitations demoralize the enemy and disintegrate his formations. Commanders of exploiting units anticipate this situation and prepare to transition to a pursuit. They remain alert for opportunities that develop as enemy cohesion and resistance break down. Commanders posture CSS forces to support exploitation opportunities.

PURSUIT

7-75. A pursuit is a type of offensive operation designed to catch or cut off a hostile force attempting to escape with the aim of destroying it. Pursuits are decisive operations that follow successful attacks or exploitations. They occur when the enemy fails to organize a defense and attempts to disengage. If it becomes apparent that enemy resistance has broken down entirely and the enemy is fleeing, a force can transition to a pursuit from any type of offensive operation. Pursuits encompass rapid movement and decentralized control. Unlike exploitations, commanders can rarely anticipate pursuits, so they normally do not hold forces in reserve for them.

7-76. For most pursuits, commanders designate a direct pressure force and an encircling or enveloping force. The direct pressure force maintains pressure against the enemy to keep him from establishing a coherent defense. The encircling force conducts an envelopment or a turning movement to block the enemy's escape and trap him between the two forces. The trapped enemy force is then destroyed. The encircling force must have greater mobility than the pursued enemy force. Joint air assets and long-range precision fires are essential for slowing enemy movement.

7-77. Exploitations and pursuits test the audacity and endurance of soldiers and leaders. After an attack, soldiers are tired and units have suffered personnel and materiel losses. As an exploitation or pursuit unfolds, LOCs extend and commanders risk culmination. Commanders and units must exert extraordinary physical and mental effort to sustain momentum, transition to other operations, and translate tactical success into operational or strategic victory.

CONDUCTING OFFENSIVE OPERATIONS

7-78. Commanders direct the operations process. They strive for continuous attacks at tempos the enemy cannot match. Commanders visualize the situation, make effective decisions, and assess the planning, preparation for, and execution of offensive operations. Staffs help commanders anticipate the outcome of current and planned operations. Commanders apply judgment to develop the situational understanding upon which they base decisions that lead to mission success (see FM 6-0).

PLANNING CONSIDERATIONS FOR OFFENSIVE OPERATIONS

7-79. Commanders plan to attack enemy forces and systems simultaneously throughout the AO to seize the initiative, exploit success, and maintain momentum. In the decisive operation, commanders focus combat power to defeat the enemy. They conceive simple plans by assessing and visualizing their battlespace and mission. Commanders select the best course of action and develop a concept of operations that ensures mission accomplishment.

7-80. Commanders tailor their concept of operations to the situation. Offensive plans—

- Allow rapid concentration and dispersal of units.
- Introduce fresh forces to exploit success while resting other forces.
- Protect the force.
- Facilitate transition to future operations.
- Sustain forces throughout the operation.

Offensive planning may occur while units defend. Plans anticipate shifting efforts and transitioning to other forms of attack to exploit opportunities. By planning to exploit success, commanders avoid losing momentum.

7-81. Staffs analyze the situation in terms of METT-TC to understand the mission and to prepare estimates. Staff sections maintain current estimates for their functional fields or battlefield operating system throughout an offensive operation. Commanders incorporate staff estimates into their visualization. As the operation unfolds and the situation changes, commanders

continuously assess threats and opportunities and decide whether to modify the concept of operations (see FM 5-0).

Mission

7-82. Commanders provide their subordinates with a clear statement of what to accomplish and why—the mission. They anticipate likely developments. To prepare subordinates for subsequent actions, commanders give them their superior's mission and intent, tell them what they envision for the future, and issue warning orders as appropriate. To maintain momentum, they assign subordinates tasks that encompass the full scope of the operation. Some offensive operations, such as deliberate attacks, require greater control and coordination. However, whenever possible, commanders assign force-oriented objectives and AOs and avoid restrictive control measures.

Enemy

7-83. In offensive operations, commanders look for gaps or weaknesses in enemy defenses. They study enemy defensive preparations and direct actions to obstruct and frustrate them. They set priorities for ISR operations. They plan to penetrate enemy security areas, overcome obstacles, avoid enemy strengths, and destroy the coherence of the defense. Success requires an active, responsive intelligence effort oriented on critical units and areas.

Terrain and Weather

7-84. Commanders select avenues of approach that orient on key terrain and provide maneuver opportunities for attackers. Good avenues of approach permit rapid advance, provide cover and concealment, allow good communications, and are hard to block with obstacles. Commanders exploit weather conditions that affect mobility, concealment, and air support. They need tactical weather forecasts that focus on how weather might affect the operation.

7-85. Terrain designated for the decisive operation should allow for rapid movement into the enemy rear. Commanders typically identify and avoid terrain that will hinder a rapid advance; however, an initial maneuver over difficult terrain may surprise defenders. Commanders personally reconnoiter the terrain whenever possible, particularly the terrain where they will conduct the decisive attack.

7-86. Attackers pay particular attention to obstacles. Commanders plan to negotiate or avoid urban areas, rivers, extreme slopes, thick forests, or soft ground. Such terrain, when it parallels axes of advance, can protect attackers' flanks. Light forces can use such areas as avenues of approach, or they can defend from them, freeing heavier forces for maneuver. To deny key terrain to the enemy, commanders seize it or control it by fire. Most offensive operations are force-oriented; however, attacks can focus on decisive terrain.

7-87. Weather and visibility conditions affect offensive operations. Concealment and protection from air attacks that weather or light conditions offer is important, especially for air assault and airborne operations. Ground conditions affect the number of avenues available and movement speed. Inclement weather also increases heavy force maintenance and CSS requirements.

Troops and Support Available

7-88. Commanders consider a unit's readiness and its leaders' experience when assigning missions. They take into account their force's mobility, protection, and firepower relative to enemy capabilities.

7-89. Commanders employ units according to their capabilities and limitations. The number of possible force combinations enhances agility. Dismounted infantry can attack through heavy cover or penetrate antiarmor defenses to open approaches for armored and mechanized forces. Air assault and airborne units can seize objectives in depth to block enemy reserves or secure choke points. Armor can move rapidly through gaps to disorganize the defense. Field and air defense artillery, engineer, and chemical units provide critical support. Aviation maneuvers to attack the enemy throughout the AO.

7-90. Attackers carefully integrate CSS operations into plans. Effective CSS is especially important during high-tempo operations. Habitually associating combat units with the CSS units that support them facilitates it. When plans call for attacking units to pass through defending units, defending units assist CSS operators in conducting sustaining operations.

Time Available

7-91. Commanders consider the risk involved when deciding how much time to allocate to planning and preparing an offensive operation. The more time attackers take to plan and prepare, the more time defenders have to improve their defenses. Attackers reduce the time available to the enemy by operating at a high tempo, achieving surprise, and avoiding detection. Defenders gain time by delaying and disrupting attacks. In all cases, commanders give as much time as possible to their subordinates for planning.

7-92. Modern telecommunications capabilities and activities in the information environment may reduce the time available to plan and prepare. Modern information systems reduce the time required to collect and process information. This reduction may provide advantages for either attackers or defenders. Commanders who act quickly and make good decisions retain the initiative in fast-moving situations. Activities in the information environment, such as live news broadcasts of pending or ongoing attacks, may reduce the time available to accomplish a mission.

Civil Considerations

7-93. Civil considerations are present throughout offensive operations. Commanders focus their staffs on considerations that may affect mission accomplishment. These factors include care and support for civilians within the AO and the possible effect of refugees on operations and movements. Other considerations include enemy locations with respect to civil populations, political and cultural boundaries, and language requirements. Civil considerations may preclude the attack of some targets, such as infrastructure and historically significant areas. They may also limit the use of land mines.

7-94. Enemy propaganda may affect the attitude of civilians in the AO. It may also affect domestic and foreign support for the operation. Operational commanders pay particular attention to the effects of actions in the information environment. Tactical commanders may have limited awareness of

media reporting and its effect on public opinion. Operational commanders gauge the effect of public opinion and keep their subordinates informed.

PREPARING FOR OFFENSIVE OPERATIONS

7-95. Preparation postures the force to begin offensive operations. It includes assembling and positioning necessary resources. At the operational level, commanders arrange forces and resources to allow dispersion, responsiveness, protection, and sustainment, while retaining the ability to mass effects quickly. Commanders assign units a position and time to begin or support the attack. Selected friendly forces start conducting shaping and sustaining operations to develop opportunities for the entire force. To preserve surprise, attacking forces avoid and mask actions that could alert the enemy.

7-96. Preparation includes reconnaissance operations conducted concurrently with planning (see FM 5-0). Reconnaissance collects information that is processed into intelligence and incorporated into plans. Intelligence tasks for offensive operations include identifying and locating enemy reserves, locating and tracking enemy fire support systems, and gathering information about enemy intelligence, air, and air defense capabilities. Conducting aggressive reconnaissance and surveillance, integrating joint collection assets, and exploiting the capabilities of information systems allow commanders to assess enemy capabilities and anticipate his reactions. Rehearsals help subordinates fully understand the commander's intent and how their actions relate to those of other friendly forces and contribute to the overall operation.

7-97. Sustaining operations create conditions for executing an attack suddenly, violently, and efficiently. More important, they help preserve freedom of action as one operation or phase ends and another begins. At the operational level, sustainment is a key consideration in linking battles within major operations. CSS forces prepare by positioning supplies and units to support the operation. Movement control, terrain management, and engineer-conducted mobility operations contribute to efficient movements. Engineers also conduct countermobility operations to protect flanks. As in all operations, air defense forces protect the force from air and missile attack.

EXECUTING OFFENSIVE OPERATIONS

7-98. Offensive operations require rapid shifts in the focus of combat power to take advantage of opportunities. Sustaining a tempo the enemy cannot match is vital to success. Commanders vary the tempo and methods of attack, while maintaining momentum. Units press the fight. A commander's ability to continually anticipate and visualize both enemy and friendly situations is essential. Making timely decisions is likewise important.

7-99. Commanders increase the tempo of an operation through reconnaissance and by providing the proper field artillery and other combat support, including air support. They maintain a high tempo by passing forces forward and minimizing the time friendly forces spend under fire. Attacks succeed only if they achieve their objective before the enemy recovers his balance, identifies the threat, and masses combat power against it. Attackers must keep the enemy off balance as long as possible and maintain the momentum

of the attack. Successful attacks maintain a tempo and degree of lethality that the enemy cannot match.

7-100. ISR and IM provide commanders with enough relevant information to direct their attack. Commanders attack once they have sufficient information, even if it is not comprehensive. They can seize the initiative by attacking, even without a detailed operational picture or COP.

7-101. The violence and intensity of the assault unhinges the coherence of the enemy's defense. Precision fires and IO allow attackers to strip away enemy security forces, cripple enemy C2 and CSS, and mislead defenders as to the true objective of the attack. The combined effects of these and other actions hinder the enemy's ability to make decisions. As attacking forces assault the objective, fires shift, fixing the enemy in depth and denying him the use of reserves. Whether seeking to destroy an enemy force or to seize terrain, the attacking force does not slow until it achieves success. A high tempo contributes to protection and enhances security.

7-102. Commanders integrate fires with maneuver throughout offensive operations. Accomplishing this requires detailed planning and coordination between assaulting and supporting forces, precise execution, and careful control of fire support. Dismounted assault forces move as closely behind their fires as possible. Armored forces attack under overhead field artillery fire. Air assault and airborne forces land directly on or as near to objectives as possible, once defenders and supporting field and air defense artillery have been suppressed or destroyed. As attackers near the enemy force, they overcome resistance with violent, massed firepower and rapid movement. Speed during this phase is essential to reduce casualties and avoid becoming stalled. Air defense and joint air assets destroy enemy air threats. Attack aviation strikes against uncommitted forces and reserves to isolate current engagements, shape future battles, and deny the enemy options.

7-103. Attackers quickly move through the objective, destroying remaining enemy resistance. They anticipate a counterattack by maneuver forces, indirect fires, or aircraft. Security is paramount, as the attacker now occupies a position known to the enemy. Attackers consolidate on the objective, reorganize to meet a counterattack, prepare for the next mission, or continue the attack. If the situation allows, commanders immediately begin an exploitation, either with the same force or by passing follow-on forces through the objective area. Reconstitution may be necessary to return units to the fight. Initial attacking forces may reconstitute as follow-on forces pass forward.

7-104. To maintain offensive momentum, commanders direct the introduction of fresh troops into the attack. Passing follow-on forces allows commanders to rest soldiers, resupply units, and move them to new areas and missions. The introduction of fresh troops is most common when forces enter an exploitation or pursuit, but may be necessary during the attack itself if committed forces cannot reach their objectives. Commanders usually commit fresh troops through a forward passage of lines to maintain the tempo and avoid a significant pause. A forward passage may occur before or after the attack starts. For it to be successful, a forward passage must be concealed from the enemy.

7-105. Forward passages of lines and offensive reliefs require detailed planning and preparation. Planning a passage includes determining the battle

handover criteria that designate when the passing force assumes the fight from the stationary force. The common higher headquarters of the two forces designates control measures for the passage. Subordinate commanders coordinate the details. During a passage, the stationary force provides all possible support to the passing force. The stationary force integrates its direct and indirect fires into the fire support plan of the passing force.

THE IMPACT OF TECHNOLOGY

7-106. Technology is changing the ways that modernized Army forces attack. Information technology allows commanders and subordinates to share a COP tailored to each echelon. Commanders throughout the attacking force use it to achieve greater situational understanding. They conduct operations based on more accurate and current information than ever before. Commanders may now lead from the front while remaining fully connected to the C2 system and the information it provides. Situational understanding, supported by the COP, allows commanders to synchronize their forces effectively and make rapid adjustments as the situation changes. Subordinates can view the overall situation and exercise initiative to achieve the commander's intent without waiting for higher headquarters to provide direction.

7-107. Situational understanding based on an accurate COP changes the nature of maneuver before and during attacks. With it, Army forces depend less on movements to contact and meeting engagements to create the conditions to attack. Modernized Army forces may avoid movements to contact altogether, developing the situation largely out of contact. Advanced surveillance and reconnaissance assets refine the picture of the enemy, while precision fires and IO destroy enemy cohesion. Reconnaissance and security elements maintain contact only as required to collect information that unmanned sensors cannot. Commanders maneuver forces into position to begin the attack before major forces make contact. Attacks unfold as simultaneous sets of blows that bewilder and shock enemy forces. Attacks become opportunistic and fluid as commanders mass the effects of combat power swiftly and decisively and exploit the results ruthlessly.

7-108. Fusing information from C2, ISR, indirect fire, and CSS systems increases tempo and the number of offensive options. Greater awareness of enemy and friendly forces means attacks need not originate from one place. Better situational understanding allows commanders to shift forces and efforts from one area to another to exploit opportunities. Nonlinear operations in noncontiguous AOs occur more frequently. Commanders project attacking forces on multiple axes throughout the AO. Lines of operations in the offense are related less by space than they are by purpose; thus, commanders bypass some enemy forces while focusing combat power at the decisive point. Exploiting opportunities that result from efficiently fusing information and determining its significance secures the initiative with attackers.

Chapter 8

Defensive Operations

Little minds try to defend everything at once, but sensible people look at the main point only; they parry the worst blows and stand a little hurt if thereby they avoid a greater one. If you try to hold everything, you hold nothing.

Frederick the Great

8-1. Army forces defend until they gain sufficient strength to attack. Defensive operations defeat an enemy attack, buy time, economize forces, or develop conditions favorable for offensive operations. Alone, defensive operations normally cannot achieve a decision. Their purpose is to create conditions for a counter-offensive that allows Army forces to regain the initiative. Although offensive operations are usually required to achieve decisive results, it is often necessary, even advisable at times, to defend. Commanders defend to buy time, hold terrain, facilitate other operations, preoccupy the enemy, or erode enemy resources.

CONTENTS

Purposes of Defensive Operations.....	8-1
Characteristics of Defensive Operations.....	8-2
Preparation.....	8-2
Security.....	8-2
Disruption.....	8-3
Massing Effects.....	8-3
Flexibility.....	8-3
Types of Defensive Operations.....	8-3
Mobile Defense.....	8-4
Area Defense.....	8-5
Retrograde.....	8-5
Defensive Operations Within the	
Operational Framework.....	8-8
Decisive Operations in the Defense.....	8-9
Shaping Operations in the Defense.....	8-11
Sustaining Operations in the	
Defense.....	8-12
Considerations for Nonlinear	
Defensive Operations.....	8-12
Conducting Defensive Operations.....	8-12
Planning for Defensive	
Operations.....	8-13
Preparing for Defensive Operations.....	8-15
Executing Defensive Operations.....	8-16
The Impact of Technology.....	8-18

PURPOSES OF DEFENSIVE OPERATIONS

8-2. The purpose of defensive operations is to defeat enemy attacks. Defending forces await the attacker's blow and defeat the attack by successfully deflecting it. Waiting for the attack is not a passive activity. Army commanders seek out enemy forces to strike and weaken them before close combat begins.

8-3. Operationally, defensive operations buy time, economize forces, and develop conditions favorable for resuming offensive operations. Therefore, major operations and campaigns combine defensive operations with offensive

operations. Operational-level defensive operations normally include offensive, stability, and support operations.

8-4. During force projection, defensive operations by in-theater or early arriving forces can maintain the operational initiative for joint or multinational forces. If conditions do not support offensive operations, initial-entry forces defend the lodgment while the joint force commander builds combat power. Initial-entry forces should include sufficient combat power to deter, attack, or defend successfully.

CHARACTERISTICS OF DEFENSIVE OPERATIONS

8-5. Successful defenses are aggressive; they use direct, indirect, and air-delivered fires; information operations (IO); and ground maneuver to strike the enemy. They maximize firepower, protection, and maneuver to defeat enemy forces. Static and mobile elements combine to deprive the enemy of the initiative. The defender resists and contains the enemy. Defending commanders seek every opportunity to transition to the offensive.

8-6. While the fundamentals of the defense continue to apply to a modernized force, advanced technology systems modify the way commanders conduct defensive operations. Greater understanding of friendly and enemy situations and the fusion of command and control (C2); intelligence, surveillance, and reconnaissance (ISR); long-range precision fires; and combat service support (CSS) technologies make the mobile defense even more lethal and effective. Whenever practical, commanders of modernized forces use the mobile defense because it takes maximum advantage of Army force strengths.

8-7. An effective defense engages the enemy with static and mobile forces. It combines the elements of combat power to erode enemy strength and create conditions for a counterattack. Defenders seek to increase their freedom to maneuver while denying it to the attacker. The enemy falters as losses increase and the initiative shifts to the defender, allowing counterattacks. Counterattack opportunities rarely last long; defenders strike swiftly to force the enemy to culminate. Preparation, security, disruption, massing effects, and flexibility all characterize successful defensive operations.

PREPARATION

8-8. The defense has inherent strengths. The defender arrives in the area of operations (AO) before the attacker and uses the available time to prepare. Defenders study the ground and select positions that allow massing fires on likely approaches. They combine natural and manmade obstacles to canalize attacking forces into engagement areas. Defending forces coordinate and rehearse actions on the ground, gaining intimate familiarity with the terrain. They place security and reconnaissance forces throughout the AO. These preparations multiply the effectiveness of the defense. Preparation ends only when defenders retrograde or begin to fight. Until then, preparations are continuous. Preparations in depth continue, even as the close fight begins.

SECURITY

8-9. Commanders secure their forces principally through security operations, force protection, and IO. Security operations help deceive the enemy as to

friendly locations, strengths, and weaknesses. They also inhibit or defeat enemy reconnaissance operations. These measures provide early warning and disrupt enemy attacks early and continuously. Force protection efforts preserve combat power. Offensive IO inaccurately portray friendly forces and mislead enemy commanders through military deception, operations security, and electronic warfare. These measures contribute to the defender's security.

DISRUPTION

8-10. Defenders disrupt attackers' tempo and synchronization with actions designed to prevent them from massing combat power. Disruptive actions attempt to unhinge the enemy's preparations and, ultimately, his attacks. Methods include defeating or misdirecting enemy reconnaissance forces, breaking up his formations, isolating his units, and attacking or disrupting his systems. Defenders never allow attackers to fully prepare. They use spoiling attacks before enemies can focus combat power, and counterattack before they can consolidate any gains. Defenders target offensive IO against enemy C2 systems and constantly disrupt enemy forces in depth.

MASSING EFFECTS

8-11. Defenders seek to mass the effects of overwhelming combat power where they choose and shift it to support the decisive operation. To obtain an advantage at decisive points, defenders economize and accept risk in some areas; retain and, when necessary, reconstitute a reserve; and maneuver to gain local superiority at the point of decision. Defenders may surrender some ground to gain time to concentrate forces.

8-12. Commanders accept risk in some areas to mass effects elsewhere. Obstacles, security forces, and fires can assist in reducing risk. Since concentrating forces increases the threat of large losses from weapons of mass destruction (WMD), commanders use deception and concealment to hide force concentrations. They also protect their forces with air and missile defenses.

FLEXIBILITY

8-13. Defensive operations require flexible plans. Planning focuses on preparations in depth, use of reserves, and the ability to shift the main effort. Commanders add flexibility by designating supplementary positions, designing counterattack plans, and preparing to counterattack.

TYPES OF DEFENSIVE OPERATIONS

8-14. The three types of defensive operations are the mobile defense, area defense, and retrograde. All apply at both the tactical and operational levels of war. *Mobile defenses* orient on destroying attacking forces by permitting the enemy to advance into a position that exposes him to counterattack. *Area defenses* orient on retaining terrain; they draw the enemy in an interlocking series of positions and destroy him largely by fires. *Retrogrades* move friendly forces away from the enemy to gain time, preserve forces, place the enemy in unfavorable positions, or avoid combat under undesirable conditions. Defending commanders combine the three types to fit the situation.

8-15. All three types of defense use mobile and static elements. In mobile defenses, static positions help control the depth and breadth of the enemy penetration and retain ground from which to launch counterattacks. In area defenses, commanders closely integrate patrols, security forces and sensors, and reserve forces to cover gaps among defensive positions. They reinforce positions as necessary and counterattack as directed. In retrograde operations, some units conduct area or mobile defenses or security operations to protect other units that execute carefully controlled maneuver or movement rearward. They use static elements to fix, disrupt, turn, or block the attackers. They use mobile elements to strike and destroy the enemy.

MOBILE DEFENSE

8-16. The *mobile defense* is a type of defensive operation that concentrates on the destruction or defeat of the enemy through a decisive attack by a striking force (see Figure 8-1). A mobile defense requires defenders to have greater mobility than attackers. Defenders combine offensive, defensive, and delaying actions to lure attackers into positions where they are vulnerable to counterattack. Commanders take advantage of terrain in depth, military deception, obstacles, and mines while employing fires and maneuver to wrest the initiative from the attacker.

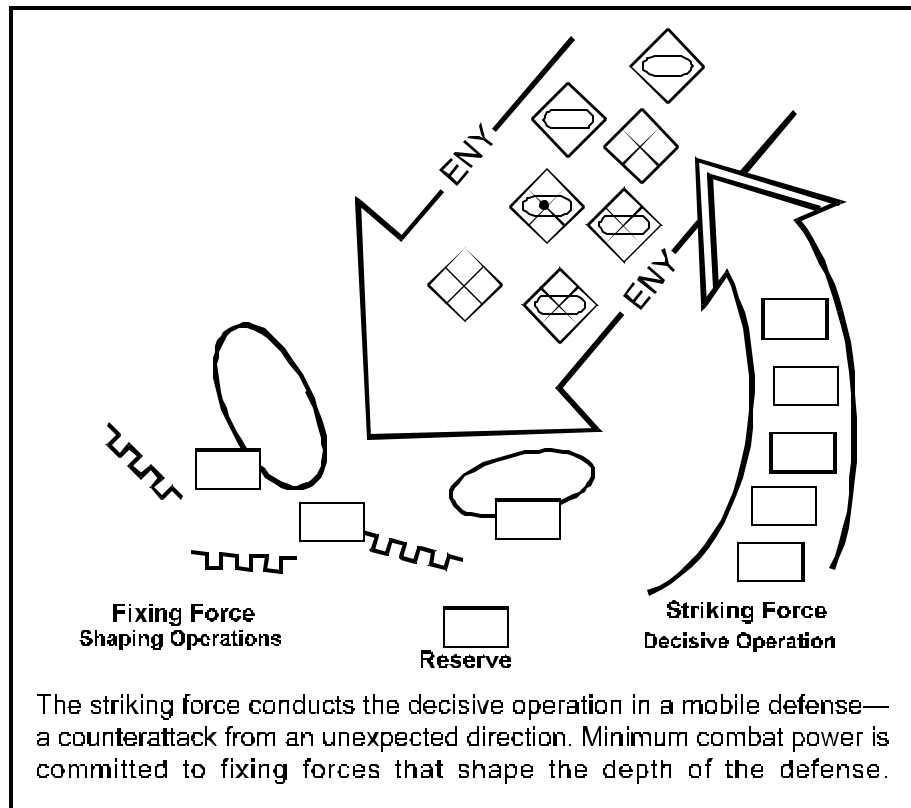

Figure 8-1. Mobile Defense

8-17. Commanders commit the minimum force necessary to purely defensive tasks. They place maximum combat power in a striking force that

counterattacks as the enemy maneuvers against friendly positions. Striking forces are considered committed throughout the operation. They have one task: plan, prepare, and execute the decisive operation—the counterattack. Defenders draw attackers into terrain that enables the striking force to counterattack from an unexpected direction. They press the counterattack with overwhelming force and violence.

A *striking force* is a committed force organized to conduct the decisive attack in a mobile defense. It normally comprises the maximum combat power available to the commander at the time of the attack.

8-18. In planning a counterattack, commanders consider enemy options and the likely locations of possible follow-on forces. Commanders decide where to position the striking force, what routes and avenues of approach to use, what fire support is necessary, and what interdiction or attack on follow-on forces will isolate the enemy. They combine military deception and security operations to render enemy reconnaissance ineffective.

8-19. In addition to the striking force, commanders designate a reserve, if forces are available. Reserves are uncommitted forces and may execute numerous missions. They give the commander flexibility. Reserves support fixing forces, ensuring that the defense establishes conditions for success of the counterattack. If the reserve is available after the commander commits the striking force, it exploits the success of the striking force.

AREA DEFENSE

8-20. The ***area defense*** is a type of defensive operation that concentrates on denying enemy forces access to designated terrain for a specific time rather than destroying the enemy outright (see Figure 8-2, page 8-6). The bulk of defending forces combine static defensive positions, engagement areas, and small, mobile reserves to retain ground. Keys to successful area defenses include effective and flexible control, synchronization, and distribution of fires. Area defenses employ security forces on likely enemy avenues of approach. Commanders employ a reserve with priority to the counterattack. Other potential reserve missions include blocking enemy penetrations and reinforcing other portions of the defense. Area defenses can also be part of a larger mobile defense.

8-21. Area defenses vary in depth, design, and purpose according to the situation. Commanders deny or retain key terrain if the friendly situation gives no other option or friendly forces are outnumbered. Lower-echelon tactical units may position their forces in battle positions on suitable terrain. On occasion, commanders may use a strong point to deny key terrain to the enemy and force his movement in a different direction. Constructing a strong point requires considerable time and engineer support.

RETROGRADE

8-22. A ***retrograde*** is a type of defensive operation that involves organized movement away from the enemy. The three forms of retrograde operations are withdrawals, delays, and retirements. Commanders use

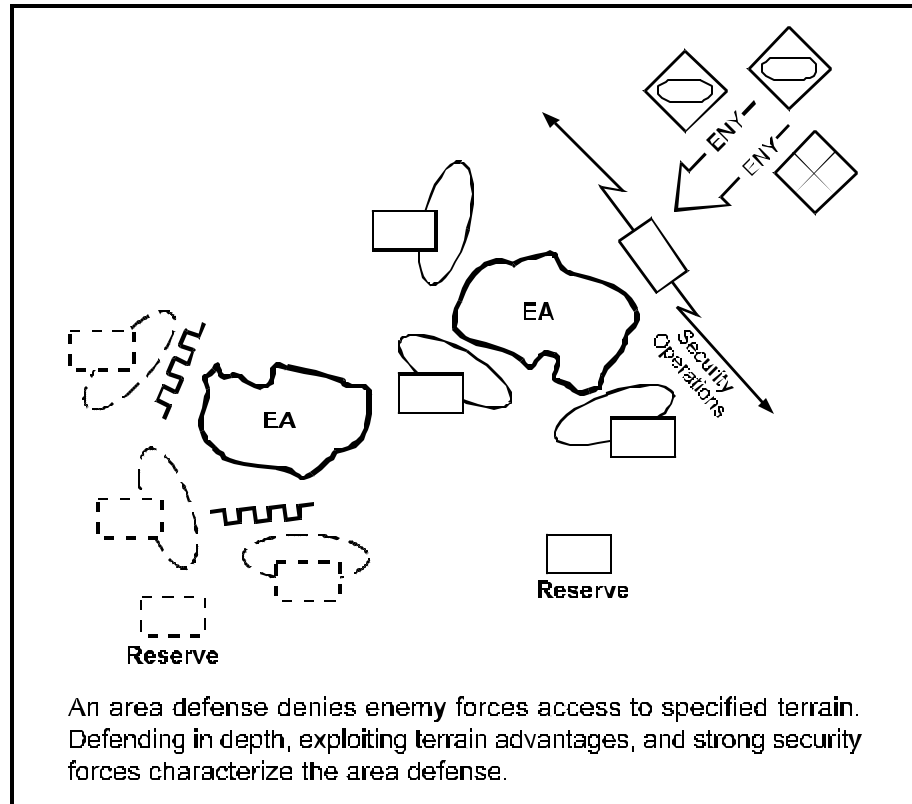

Figure 8-2. Area Defense

retrogrades as part of a larger scheme of maneuver to create conditions to regain the initiative and defeat the enemy. Retrogrades improve the current situation or prevent a worse situation from occurring. Operational-level commanders may execute retrogrades to shorten lines of communications (LOCs).

Withdrawal

8-23. A *withdrawal*, a form of retrograde, is a planned operation in which a force in contact disengages from an enemy force. Withdrawals may involve all or part of a committed force. Commanders conduct withdrawals to preserve the force, release it for a new mission, avoid combat under undesirable conditions, or reposition forces. Enemy pressure may or may not be present during withdrawals. At tactical echelons, withdrawing forces may be unassisted or assisted by another friendly force.

8-24. In a corps or division withdrawal, commanders organize a security force and a main body. The security force prevents the enemy from interfering with the withdrawal. The main body forms behind the security force and moves away from the enemy; the security force remains between the enemy and the main body and conceals main body preparations and movement. If the withdrawal begins without being detected, the security force may remain in position to prolong the concealment. After the main body withdraws a safe distance, the security force moves to intermediate or final positions. If the enemy detects the withdrawal and attacks, the security force delays to allow the main body to

withdraw. Main body units may reinforce the security force if necessary. They will themselves delay or defend if the security force fails to slow the enemy.

8-25. Commanders plan for and employ air and ground reserves, indirect and missile counterfire, and air defenses. Corps and division reserves remain near main body units to assist withdrawing units by fire and maneuver, if needed. Corps and division reserves may execute spoiling attacks to disorganize and delay the enemy or to extricate encircled or decisively engaged forces.

8-26. Commanders use IO and security operations when withdrawing to deny the enemy information and present false information. They avoid moving forces prematurely or revealing other actions that could signal their withdrawal plans. For example, relocating combat support (CS) and CSS facilities, emplacing obstacles, and destroying routes may signal a withdrawal. To seize the initiative, commanders direct offensive IO that include measures to conceal withdrawal preparations.

8-27. Commanders dedicate resources and plan for future operations when withdrawing. The ability to conduct a timely withdrawal is especially dependent upon sufficient transport. CSS planners assist in developing courses of action and adjust sustaining operations to conform to the commander's decisions. A withdrawal ends when the force breaks contact and transitions to another operation. Forces may withdraw into a defended area and join its defense, withdraw into a secure area and prepare for future operations, or continue away from the enemy in a retirement.

Delay

8-28. A *delay* is a form of retrograde in which a force under pressure trades space for time by slowing the enemy's momentum and inflicting maximum damage on the enemy without, in principle, becoming decisively engaged. Delays gain time for friendly forces to—

- Establish defenses.
- Cover defending or withdrawing units.
- Protect friendly unit flanks.
- Contribute to economy of force.
- Draw the enemy into unfavorable positions.
- Determine the enemy main effort.

8-29. Commanders direct delays when their forces are insufficient to attack or conduct an area or mobile defense. A delay is also appropriate as a shaping operation to draw the enemy into an area for subsequent counterattack. Commanders specify the critical parameters of the delay:

- Its duration.
- Terrain to retain or deny.
- The nature of subsequent operations.

8-30. Delays can involve units as large as a corps and may be part of a general withdrawal. Divisions may conduct delays as part of a corps defense or withdrawal. In a delay, units may fight from a single set of positions or delay using alternate or successive positions. A delay ends when—

- Enemy forces halt their attack. Friendly forces can then maintain contact, withdraw, or counterattack.
- Friendly forces transition to the defense.
- The delaying force completes its mission and passes through another force or breaks contact.
- The friendly force counterattacks and transitions to the offense.

8-31. Delaying units should be at least as mobile as attackers. Commanders take measures to increase friendly mobility and decrease enemy mobility. Open, unobstructed terrain that provides friendly force mobility requires major engineering efforts to hinder enemy mobility. Close or broken terrain slows the enemy but also makes it more difficult to maintain contact and may hinder friendly movement.

Retirement

8-32. A retirement is a form of retrograde in which a force not in contact with the enemy moves away from the enemy. Typically, forces move away from the enemy by executing a tactical road march. Retiring units organize to fight but do so only in self-defense. Retirements are usually not as risky as delays and withdrawals.

Risk in Retrograde

8-33. Retrogrades require firm control and risk management. They increase psychological stress among soldiers, who may see movement away from the enemy as a sign of defeat. Unless held in check, such concerns can lead to panic and a rout. Successful retrogrades require strong leadership, thorough planning, effective organization, and disciplined execution. Friendly troops move swiftly but deliberately. A disorganized retrograde in the presence of a strong enemy invites disaster. Commanders manage risk during retrogrades with these measures:

- Avoiding decisive engagement. Reserves and massed indirect and joint fires can assist in accomplishing this.
- Preparing plans to enhance rapid, controlled execution.
- Denying the enemy information on unit movement.
- Avoiding surprise with continuously updated intelligence.
- Combining deception and delaying actions to prevent the enemy from closing in strength.

DEFENSIVE OPERATIONS WITHIN THE OPERATIONAL FRAMEWORK

8-34. Commanders use the operational framework (AO, battlespace, and battlefield organization) to conduct defensive operations (see Figure 8-3). Commanders base their framework on METT-TC and an understanding of their battlespace. They conduct simultaneous and sequential decisive, shaping, and sustaining operations in depth by synchronizing their forces in time, space, resources, purpose, and action. Commanders may designate deep, close, and rear areas when conducting operations that are generally linear and contiguous.

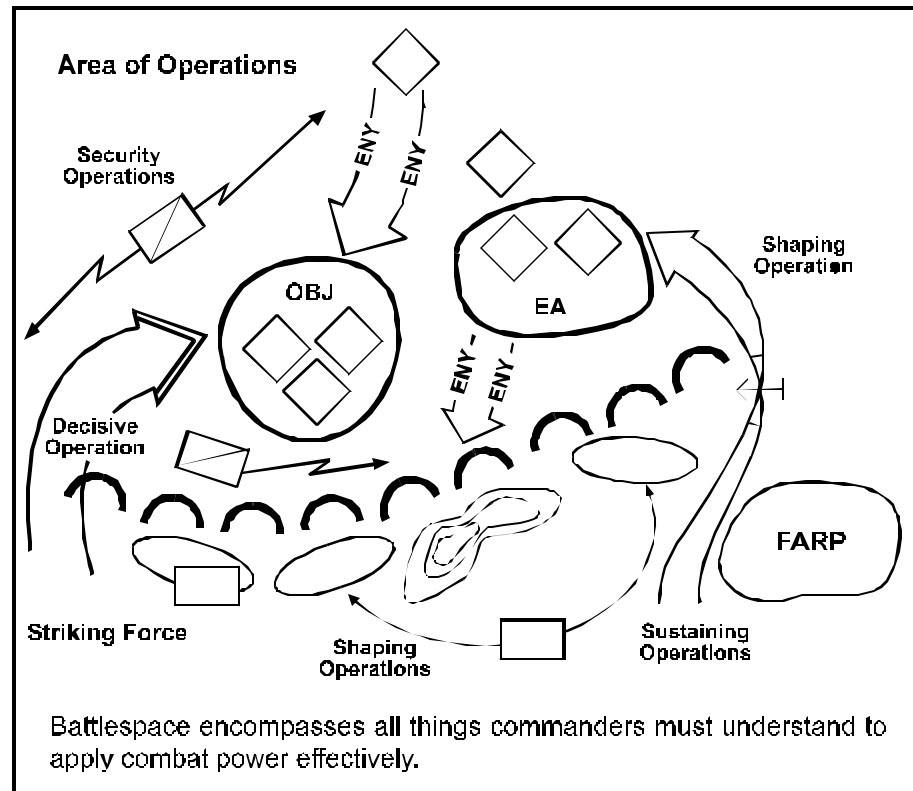

Figure 8-3. Operational Framework in the Defense

8-35. Commanders deny enemy forces freedom of movement within the gaps formed by extended, noncontiguous AOs. They dominate their entire AO throughout the operation, assigning responsibility for unoccupied ground and allocating combat power. When commanders designate subordinate unit AOs that are noncontiguous, they retain responsibility for portions of their AO not assigned to subordinates. Regardless of the proximity or separation of its elements, commanders see their defense as a continuous whole. They fight decisive, shaping, and sustaining operations as one action, synchronizing simultaneous operations to accomplish a single purpose: defeating the attack and quickly transitioning to the offense.

DECISIVE OPERATIONS IN THE DEFENSE

8-36. The decisive operation in a defense defeats the enemy attack. In a mobile defense, the counterattack by the striking force is the decisive operation. The more commanders know about the enemy situation, the more they can weight the counterattack. In area defenses, defeating the enemy attack within engagement areas is the decisive operation. Commanders draw the enemy into engagement areas, where defenders destroy them using massed fires, obstacles, and other assets.

8-37. Throughout the execution of mobile and area defenses, commanders designate a main effort and synchronize the battlefield operating systems (BOS) to support it. If necessary, they shift their main effort to concentrate forces and mass effects. Defending commanders may shift their main effort repeatedly to

defeat an attack. If they correctly anticipate enemy actions, commanders can execute their plan for the decisive operation despite shifting the main effort. They always designate the decisive operation as the main effort at the decisive point.

8-38. Reserves preserve commanders' flexibility and provide a hedge against uncertainty. Once, the reserve is committed, its operation becomes the main effort. If commanders commit their reserve, they should immediately designate another from uncommitted forces or forces in less threatened areas. Commanders may employ reserves throughout the operation. Typical reserve missions include counterattacking, reinforcing, blocking, and destroying a penetration. Commanders avoid assigning tasks to the reserve other than those required to support planning and preparing for their be-prepared missions. Reserves are best used to reinforce and expedite victory rather than prevent defeat. The concept of operations determines the reserve's primary mission. Unless otherwise delegated, the commander designating the reserve retains authority for its commitment.

Decisive Defensive Operations^{3/4} Pusan, Korea

By the end of August 1950, the North Korean People's Army (NKPA) occupied most of the Republic of Korea (ROK), less the Pusan pocket on the southeast portion of the peninsula. President Kim Il Sung was amazed at the speed with which the NKPA had moved south, and he assembled 98,000 more troops to crush the Eighth Army. Precariously held, the Pusan pocket contained about 120,000 US and ROK soldiers. The operation became hundreds of large and small engagements marked by thousands of casualties.

The NKPA struck at numerous points along the perimeter, expending men and resources in an effort to create a penetration. But the line held and fresh United Nations (UN) forces arrived to bolster the defense. Sensing that an opportunity was slipping away, the NKPA attacked with increased intensity on 31 August 1950. Despite tremendous punishment by UN air force bombing and strafing, the North Koreans breached the defensive lines in several areas. The 24th Infantry Division counterattacked, while the 1st Cavalry Division and the 1st ROK Division held at Taegu. Two enemy divisions struck the 25th Infantry Division in a bloody fight that saw Sobuk Ridge change hands 13 times in less than a month. The line held despite US units giving ground or fighting in isolation. While the NKPA made impressive gains along the perimeter, the defense held and the ports remained open.

The defense of the Pusan perimeter proved decisive in that it broke the North Korean will to continue the attack and fixed remaining enemy forces. Further north, US forces executed Operation Chromite at Inchon, a turning movement that trapped the NKPA, threatened it with imminent destruction, and allowed UN forces in the Pusan pocket to break out and resume offensive operations.

SHAPING OPERATIONS IN THE DEFENSE

8-39. Shaping operations executed simultaneously throughout the AO support the conduct of the defender's decisive operation by upsetting the attacker's design. They selectively suppress or neutralize the enemy's BOS and disrupt his synchronization. IO shape enemy perceptions and can influence the decision to attack. Fires contribute to shaping operations by attacking high-payoff targets and create conditions for successful decisive operations. Shaping operations in the defense include—

- Countermobility and mobility operations.
- Reconnaissance and security operations.
- Aerial-delivered and long-range precision indirect fires.
- Passages of lines (forward and rearward).
- Actions of fixing forces that shape to support the decisive operation.
- Movements of units that directly facilitate other shaping operations and the decisive operation.
- Actions by reserve forces before their commitment.

8-40. Security forces perform critical functions in the defense. They secure gaps between defending units, protect the force from surprise, meet the leading enemy forces, strip away reconnaissance and security elements, report enemy strengths and locations, and help identify the enemy decisive operation. They harass and slow attacking forces to gain time and space for shaping enemy actions and protecting LOCs, headquarters, fire support units, and reserves.

Shaping Defensive Operations^{3/4} 2d SANG Brigade at Khafji

Defensive operations often have significant political implications. During the evening of 29 January 1991, the Iraqi 5th Mechanized Division launched several large probes across the Saudi Arabian border. Elements of the 2d Saudi Arabian National Guard (SANG) Brigade—a force accompanied by American advisors and a Marine air/naval gunfire liaison company—met them at the town of Khafji, Saudi Arabia. The Iraqis seized the town, cutting off two Marine reconnaissance teams, who evaded capture while continuing to call in air and field artillery support. The next day, the 2d SANG Brigade attempted to retake Khafji without success. However, on 31 January, the brigade attacked again, and by 1 February succeeded in clearing Iraqi resistance.

This relatively small tactical action was important because it convinced the theater commander that the Iraqis could not conduct complex operations and were vulnerable to air interdiction. This information helped to shape future coalition operations. The action, by demonstrating that the Saudi forces would fight aggressively, strengthened the coalition and bolstered its will. Lastly, the operation demonstrated that US and coalition forces could conduct successful multinational operations, a discovery with strategic implications.

SUSTAINING OPERATIONS IN THE DEFENSE

8-41. Sustaining operations in the defense occur throughout the AO. Commanders ensure freedom of action and continuity of the defense by conducting CSS operations, rear area and base security, LOC maintenance, movement control, and terrain management.

8-42. Security for sustaining operations is a primary concern. Commanders organize forces and terrain to protect sustaining operations and retain freedom of action. Commanders group forces performing sustaining operations into bases and base clusters for protection and security. Base and base clusters organize for self-defense. Commanders designate response forces and tactical combat forces (TCFs) to augment base cluster self-defense capabilities (see FM 3-90; FM 3-100.7).

8-43. Force projection operations present distinct security challenges for sustaining operations. To protect combat power buildup, combat, CS, and CSS forces operate in the same area while establishing the initial lodgment. Forces conducting sustaining operations take increased active and passive self-protection measures until combat forces are available. Commanders assess threat capabilities, decide where and when to accept risk, and assign units to protect and sustain the force.

CONSIDERATIONS FOR NONLINEAR DEFENSIVE OPERATIONS

8-44. Commanders may conduct nonlinear defensive operations in contiguous and noncontiguous AOs. In both cases, defenders focus on destroying enemy forces, even if it means losing physical contact with other friendly units. Successful nonlinear defenses require all friendly commanders to understand the higher commander's intent and share a current common operational picture (COP). They also favor use of a battlefield organization based on decisive, shaping, and sustaining operations rather than deep, close, and rear areas. Noncontiguous defenses are generally mobile defenses; however, some subordinate units may conduct area defenses to hold key terrain or canalize attackers into engagement areas. Even mobile defenses that begin as linear operations often evolve into nonlinear operations. Area defenses are typically more linear operations because of their orientation on terrain.

8-45. Nonlinear defenses place a premium on reconnaissance and surveillance to maintain contact with the enemy, produce relevant information, and develop and maintain a COP. The defending force focuses almost exclusively on defeating the enemy force in depth rather than retaining large areas due to the size of the AO. All forces conducting nonlinear defenses require robust communications and sustainment capabilities. Noncombatants and the fluidity of nonlinear defensive operations require commanders to exercise judgement in clearing fires, both direct and indirect.

CONDUCTING DEFENSIVE OPERATIONS

8-46. Before deciding how to defend, commanders assess the situation and begin to plan. A simple concept of operations flexible enough to meet the enemy wherever he chooses to attack is essential for success in the defense. Operational-level defenses combine all three types of defensive actions. If defense of a specified area is not required, commanders may draw the enemy deep into

their AO and strike his flanks and rear. They use spoiling attacks if conditions favor them.

PLANNING FOR DEFENSIVE OPERATIONS

8-47. In planning a defense, operational commanders identify their own and the enemy's centers of gravity and related decisive points. They also identify the likely way the enemy will attack. Commanders estimate where the enemy will conduct his decisive operation and how to defeat it while maintaining the coherence of the defense. Operational commanders allocate resources and assign AOs to subordinate tactical units. They decide where and when to defend and generally match friendly strength to enemy strength.

8-48. Commanders consider the factors of METT-TC as they plan their defense. They choose defensive positions that force the enemy to make costly attacks or conduct time-consuming maneuvers to avoid them. Commanders plan IO to gain information superiority. Information superiority allows commanders to hide their intentions and deceive the enemy, while degrading the enemy's ability to synchronize his attack. Commanders plan defensive and counteroffensive operations in depth of time, space, and purpose.

Mission

8-49. The mission flows from the higher headquarters concept of operations. Commanders must understand how their defensive operation contributes to the success of the higher headquarters operation. The nature of the AO and subsequent missions affect the missions commanders assign to subordinates.

Enemy

8-50. Commanders and staffs estimate enemy offensive capabilities, vulnerabilities, and operational design. At tactical levels, commanders estimate enemy strengths, weaknesses, and intent. They infer potential enemy courses of action and focus their estimates on the most dangerous and most likely of them. Commanders and units respect, but are not paralyzed by, enemy capabilities. Defending commanders view themselves and their AOs through the enemy commander's eyes and anticipate how he might attempt to seize terrain or destroy friendly forces.

8-51. Defending commanders conduct a thorough intelligence preparation of the battlefield (IPB) as part of their visualization. IPB enables commanders and staffs to anticipate the enemy's objectives and courses of action and helps determine what control measures to use. In particular, planners anticipate enemy use of indirect approaches and capability to attack friendly C2 and sustaining operations.

8-52. Commanders use every resource available to offset attackers' numerical advantages, identify threats, and mass combat power against their vulnerabilities. Victory requires accurate and timely in-depth targeting of enemy units, facilities, and systems. Real-time fusion of information among C2, ISR, fire support, engineer, aviation, and CSS elements helps commanders do this. A successful defense compels enemies to commit to a course of action before they want to and creates opportunities for friendly forces.

Terrain and Weather

8-53. Defenders analyze the terrain to decide where they can best kill the enemy. Defending large AOs requires commanders to take risks and accept gaps. Smaller AOs may restrict maneuver and limit flexibility. Subordinate unit AOs should extend far enough toward the enemy to give commanders time to assess enemy capabilities and intentions, visualize the operation, decide on a course of action, and execute it. Operational-level commanders consider large-scale geographic features and choose the best terrain for defending based on their mission. The geography should hinder operational mobility of large enemy formations and provide advantages for the operational defense. A defense lacks value if the enemy can readily bypass it, unless the defensive focus is to retain that terrain. Commanders also consider friendly LOCs. Geography determines LOC capacity and the size force LOCs can support. Operational commanders commit significant resources to improve LOCs and friendly mobility, and to degrade enemy operational mobility.

8-54. The commander's personal reconnaissance is essential. Tactical commanders focus on identifying probable enemy assembly areas, CSS dispositions, field artillery locations, and ground favoring an attack. They also determine the area most advantageous for the enemy decisive operation. Terrain characteristics may determine the shape of the defense. Tactical commanders seek positions that offer effective cover and concealment. The defending force exploits any aspect of terrain that can slow enemy momentum or make it difficult for the enemy to mass effects or conduct maneuver.

8-55. Defenders seek to engage attackers at points where the terrain places them at the greatest disadvantage. Defending commanders use manmade obstacles to improve natural obstacles; to fix, disrupt, turn, or block enemy movement; and to protect friendly positions and maneuver. Some terrain may be so significant to the defense that its loss would prove decisive. In such cases, commanders focus their plan on retaining it.

8-56. Weather and visibility affect how defenders use terrain. Commanders plan for the effects of adverse or limited visibility on weapons systems and optical and thermal devices. A plan that succeeds in clear conditions may be less effective during bad weather. Branches to the basic plan should address necessary modifications to the defense during periods of reduced visibility. Commanders and staffs need local tactical weather information as well as the more general theater-level forecasts.

Troops and Support Available

8-57. As they visualize the operation, commanders consider the capabilities of their force, teamwork, state of training, and leader experience. The firepower, mobility, protection, health, morale, and training of troops determine, to some extent, how they defend. Differences in unit tables of organization and equipment, mobility, training, and leadership make some units more suitable for some missions than for others. In multinational operations, for example, particular defensive arrangements may be necessary to accommodate national pride or interests. Defenders exploit relative strengths in tactics and capabilities that give defenders advantages over the attackers. These may include air

assault and attack helicopter capabilities, night combat experience, long-range precision fires, intelligence, and battle command.

Time Available

8-58. The time available to prepare is a crucial factor. The defense is more effective when time is available to plan decisive, shaping, and sustaining operations; conduct reconnaissance and deliberately occupy positions; fortify the ground, plan fires, and install obstacles; coordinate maneuver, fires, and CSS; and rehearse. Commanders at all echelons manage their resources to prepare the best defense time allows. They establish priorities of support that focus work on the unit designated to conduct the decisive operation. They set priorities to focus units on the most important tasks.

8-59. Small units train to defend with minimal preparation when necessary; however, strong defenses take time to organize and prepare. To gain time for the main body to organize the defense, commanders may order a delay by a covering force or a spoiling attack by ground or air units. Lack of time and uncertainty about factors such as the enemy order of battle, main effort, and objectives may compel commanders to designate a larger reserve or accept greater risk. It may also determine the type of defense to be employed.

Civil Considerations

8-60. International law and moral imperatives require Army forces to consider the effects of operations on civilian populations. The defense of national boundaries may require operational commanders to defend in less depth than they would like. The presence of culturally, economically, and politically significant assets may limit the range of options. Countermobility operations directed at economically important roads, railways, and bridges might be prohibited. When Army forces must damage areas that are important to civilians, they ensure that civilian leaders and populations understand why these actions are necessary.

8-61. AOs with large civilian populations often require a portion of the force to conduct support operations. Units may expend significant resources to evacuate endangered populations. Commanders implement restrictive fire support coordinating measures to protect civilian facilities and areas, consistent with rules of engagement (see FM 3-09). Army forces must consider civilian movements when emplacing minefields.

PREPARING FOR DEFENSIVE OPERATIONS

8-62. Defensive preparations begin as early as possible and continue throughout the operation. Parallel planning facilitates simultaneous preparation at all command levels. As staffs prepare plans, leaders conduct a personal reconnaissance. There is no substitute for actually seeing and walking the defensive area. Commanders at all echelons integrate adjustments resulting from preparation activities. All echelons refine their plans in parallel.

8-63. A thorough rehearsal contributes to effective execution. At tactical levels, rehearsals usually take place on prominent terrain overlooking the defensive area, with a terrain model or a map. At the operational level, they involve simulations and command post exercises. Such rehearsals preceded Operations

Just Cause, Desert Shield, and Uphold Democracy. Joint exercises are often operational-level rehearsals. Rehearsals allow subordinate commanders and staffs to review what they are required to do and when. They aid mutual understanding and promote synchronized actions. Rehearsals permit adjustments to the plan and refinement of responsibilities for actions and contingencies at critical points in the operation.

8-64. The most important preparation activities include—

- Conducting rehearsals.
- Developing engagement areas.
- Executing shaping IO, including military deception operations.
- Taking force protection measures, to include strengthening air and missile defenses of critical assets.
- Executing security operations.
- Conducting reconnaissance and surveillance missions to collect information on the enemy and AO.
- Preparing reserves.
- Designating counterattack forces.
- Organizing the force for movement and support.
- Positioning forces in depth.
- Improving terrain to favor the defender.

EXECUTING DEFENSIVE OPERATIONS

8-65. Commanders consider several factors as they exercise battle command during defensive operations. Army forces conduct operations in depth; commanders consider how best to employ their force throughout the AO. Defending in depth may result in enemy penetrations or parts of the force becoming encircled; commanders visualize how to deal with these situations. Elements of the force conduct sustaining operations throughout the AO; commanders make provisions for protecting them. If WMD are present, commanders prepare the force to counter their effects. Finally, commanders visualize how they will use a counterattack to terminate the defense and transition to offensive operations.

Battle Command

8-66. Commanders position themselves at the critical place at the critical time. In the defense, this may include moving with the counterattacking force or locating with the committed reserve. Commanders should anticipate and provide for the means to exercise C2 on the move.

Operations in Depth

8-67. In both area and mobile defenses, commanders direct simultaneous operations in depth to ensure success of the decisive operation. Simultaneous shaping operations throughout the AO limit enemy options, disrupt his synchronization and affect follow-on element arrival times. Reconnaissance, surveillance, security, air elements, and special operations forces all have roles in the defense. As attackers approach, these forces monitor their activities and track committed units. They determine the avenues of approach being used, identify the greatest threat, and gain time for the main body to act.

Enemy Penetrations

8-68. Commanders use all available means to contain or destroy enemy penetrations. In an area defense, commanders block and eliminate penetrations as quickly as possible. In a mobile defense, commanders may allow a significant penetration to position attackers for destruction by the striking force. Commanders shift their main effort to counter enemy actions and create conditions that favor the decisive operation. This may require adjusting boundaries, repeatedly committing and reconstituting reserves, and executing branches to the original plan.

Encirclements and Breakouts

8-69. Units may be unintentionally cut off from friendly forces. In that case, the senior commander among the encircled units assumes control of all encircled elements and assesses the defensive posture of the force. The commander rapidly reorganizes, consolidates, and determines whether the next higher commander wants the force to break out or defend in place. If the force can break out and that action meets the higher commander's intent, it does so before the enemy has time to block escape routes.

8-70. To break out, the commander designates or organizes a force to create a penetration toward other friendly forces while the other encircled units continue defending. When the penetration is created, the defending units break contact and follow the attacking unit to rejoin friendly forces. If the force cannot break out, it continues to defend while the commander coordinates a linkup with a relieving force.

Protecting Sustaining Operations

8-71. Uninterrupted sustaining operations ensure freedom of maneuver and continuity of operations. Threats to sustaining operations may require forces and facilities to reposition. Response forces from CSS and CS units are responsible for countering threats from small tactical units. When response forces are insufficient, commanders may commit a TCF (see FM 3-90; FM 3-100.7). Because threats to sustaining operations can divert combat power from the decisive operation, commanders carefully weigh the need for such diversions against the possible consequences and decide where to accept risk.

Weapons of Mass Destruction

8-72. When present in the theater of operations, WMD present a major threat. These weapons can completely destroy the strongest defensive positions as well as obstruct maneuver. In situations where WMD may be used, commanders take both offensive and defensive actions. They attack enemy WMD C2, delivery systems, and storage areas. They protect the force through dispersion, theater missile defense, survivability positions, and individual protective measures. Commanders also adjust their operations and tactics. They fight from dispersed locations and concentrate their forces only as needed to mass the effects of fires.

Counterattacks

8-73. Counterattacks seek to wrest the initiative from the attacker. Timing is critical. Executed too soon, a counterattack may expend resources needed later for a more urgent contingency. Executed too late, it may be ineffective.

8-74. Commanders anticipate circumstances that favor counterattacks and establish information requirements that help them determine when those circumstances occur. To make these decisions wisely, commanders require relevant information about both friendly and enemy forces. Errors in computing movement and deployment times can upset the timing of the counterattack. Late or inaccurate reports about attackers can lead to executing too soon or too late. Training and experience, combined with effective information management, give commanders the relevant information needed to make the right decisions.

Terminating the Defense

8-75. Attackers culminate through friction caused by their own maneuvers, losses, errors, exhaustion, skillful friendly defenses, and other factors. At that point, the initiative passes to the defender. Commanders then designate a counterattack as the decisive operation, finish destroying the enemy force, and transition to the offense.

THE IMPACT OF TECHNOLOGY

8-76. Improved technology provides commanders increased flexibility for defensive operations. The fusion of information from C2, ISR, fire support, and CSS systems—combined with the commander's judgment—allows commanders to understand their battlespace and conduct fluid noncontiguous operations from widely dispersed locations. A COP based on this fused information helps commanders make better and quicker decisions. The increasing range and precision of direct and indirect fires allow Army forces to weaken attackers and shape the situation before entering close combat. Improved C2 and ISR systems allow commanders to disperse their forces without losing the ability to mass effects at the decisive time and place. Dispersed Army forces present tactical challenges to attackers. If attackers disperse their forces, they expose themselves to swift concentration of more mobile friendly forces. If attackers concentrate against a portion of the friendly force, the remaining friendly units maneuver in depth to isolate the enemy force and destroy it. Modern technology provides the means to conduct more flexible and deadly defensive operations than ever before. Trained soldiers and decisive leaders apply those means in uncertain situations to defeat enemies and transition to offensive operations that achieve the desired end state.

Chapter 9

Stability Operations

To defend and protect US national interests, our national military objectives are to Promote Peace and Stability and, when necessary, to Defeat Adversaries. US Armed Forces advance national security by applying military power as directed to help Shape the international environment and Respond to the full spectrum of crises, while we also Prepare Now for an uncertain future.

*The National Military Strategy
1997*

9-1. Combatant commanders employ Army forces in stability operations outside the US and US territories to promote and protect US national interests. Army forces are trained, equipped, and organized to control land, populations, and situations for extended periods. The depth and breadth of Army force capabilities provide combatant commanders important, flexible options to meet theater operational requirements.

9-2. Stability operations promote and protect US national interests by

influencing the threat, political, and information dimensions of the operational environment. They include developmental, cooperative activities during peacetime and coercive actions in response to crisis. Army forces accomplish stability goals through engagement and response. The military activities that support stability operations are diverse, continuous, and often long-term. Their purpose is to promote and sustain regional and global stability.

9-3. Although Army forces focus on warfighting, their history and current commitments include many stability operations. Even during major theater wars, Army forces conduct stability operations. These occur during combat operations and throughout the postconflict period. The US strategy of promoting regional stability by encouraging security and prosperity means Army forces will be engaged in stability operations for the foreseeable future.

CONTENTS

Engagement and Response	9-2
Peacetime Military Engagement.....	9-2
Response	9-3
Characteristics of Stability Operations.....	9-4
Types of Stability Operations.....	9-6
Peace Operations	9-6
Foreign Internal Defense	9-8
Security Assistance	9-9
Humanitarian and Civic Assistance	9-10
Support to Insurgencies.....	9-10
Support to Counterdrug Operations.....	9-11
Combatting Terrorism	9-11
Noncombatant Evacuation Operations	9-12
Arms Control	9-13
Show of Force.....	9-13
Considerations for Stability Operations....	9-14

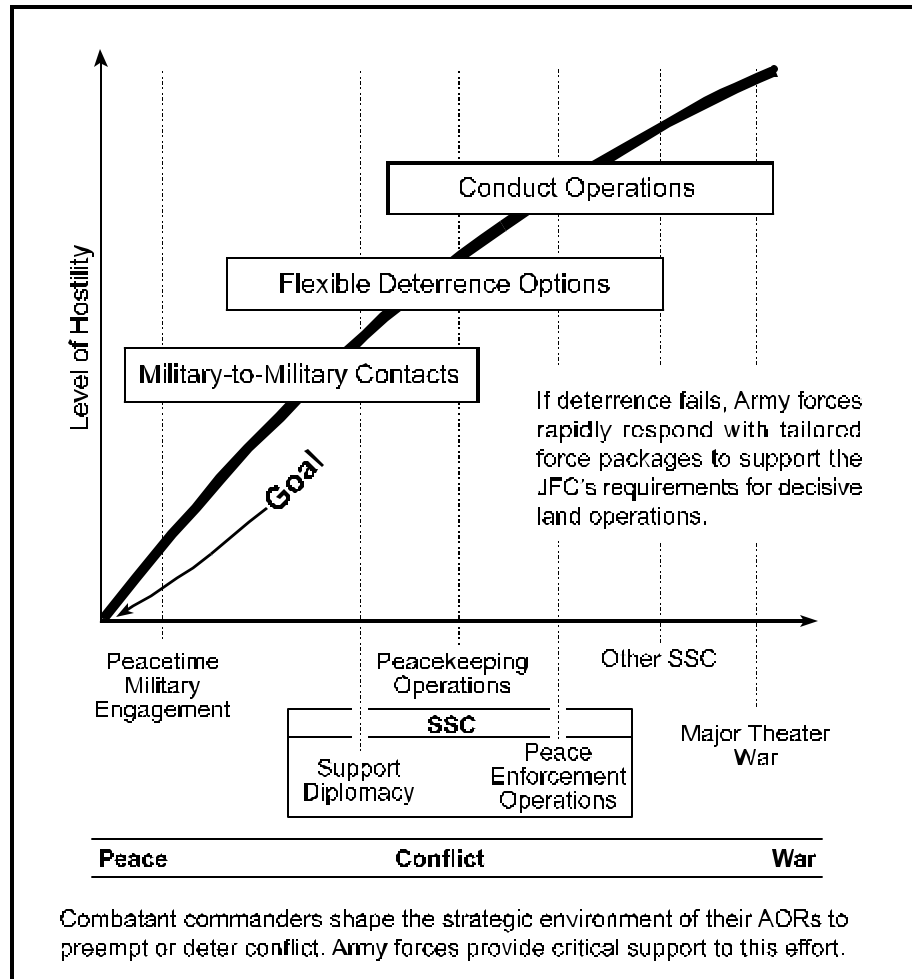

Figure 9-1. The Army Role in Theater Engagement

ENGAGEMENT AND RESPONSE

9-4. Engagement occurs in the context of the combatant commander's theater strategy (see Figure 9-1). Combatant commanders continually employ military forces to complement and reinforce other instruments of national power. Theater engagement plans (TEPs) provide frameworks within which combatant commands engage regional partners in cooperative military activities and development. Ideally, TEP activities remedy the causes of crisis before a situation deteriorates and requires coercive US military intervention.

PEACETIME MILITARY ENGAGEMENT

9-5. Combatant commanders shape their areas of responsibility through peacetime military engagement (PME). **Peacetime military engagement encompasses all military activities that involve other nations and are intended to shape the security environment in peacetime. It includes programs and exercises that the US military conducts with other nations to shape the international environment, improve mutual understanding with other countries, and improve interoperability with**

treaty partners or potential coalition partners. Peacetime military engagement activities are designed to support a combatant commander's objectives as articulated in the theater engagement plan.

Combatant commanders synchronize their TEPs with country plans (prepared by US ambassadors) and internal defense and development strategies that support theater objectives. Army forces contribute to all three, usually as partners with host nation forces and in coordination with civil agencies.

9-6. Many countries do not invest in air and sea forces. However, almost all countries have armies or land-based paramilitary or police forces. Therefore, Army forces are ideally suited for PME with host nation land forces. Army forces are equally suited for contacting and positively influencing host nation civilian populations. The objectives of PME are to—

- Open communications.
- Increase interoperability.
- Foster regional military professionalism.
- Demonstrate by example the role of the military in a democracy.

Reciprocal military-to-military contact is the primary method of executing PME. Examples include multinational training exercises, joint contact team programs, individual training exchanges, medical and engineer projects and exercises, and staff information exchanges. The reciprocity concept means all sides—US forces, host nation forces, and international partners—benefit.

9-7. Although developmental in nature, PME activities promote regional stability. They are conducted (planned, prepared, executed, and assessed) like other stability operations. However, PME uses only cooperative actions to accomplish combatant commander objectives. Successful PME activities preclude US forces from having to conduct coercive stability operations.

RESPONSE

9-8. When crises develop and the National Command Authorities (NCA) direct, combatant commanders respond. If the crisis revolves around external threats to a regional partner, combatant commanders employ Army forces to deter aggression and signal US commitment. Deploying Army forces to train in Kuwait is an example of this sort of response. If the crisis is caused by an internal conflict that threatens regional stability, US forces may intervene to restore or guarantee stability. Operation Restore Democracy, the 1994 intervention in Haiti, is an example. In other cases, regional stability requires Army force presence to guarantee postconflict agreements. Ongoing operations in the Sinai and Bosnia exemplify this sort of stability operation. Stability operations that respond to crises are smaller-scale contingencies and may include both developmental and coercive actions. *Developmental* actions enhance a host government's willingness and ability to care for its people. *Coercive* actions apply carefully prescribed force or the threat of force to change the security environment.

Rapid Response and Preclusion

9-9. A critical component of successful stability operations is the ability to rapidly respond in the early stages of an imminent or ongoing crisis. Prompt deployment of sufficient forces in the initial phase of a crisis can preclude the

need to deploy larger forces later. Effective intervention can also deny adversaries time to set conditions in their favor or accomplish destabilizing objectives. Deploying a credible force rapidly is the initial step in precluding or blocking aggression. However, deployment alone will not guarantee success. Achieving successful preclusion involves convincing the adversary that the deployed force is able to conduct decisive offensive and defensive operations.

Presence and Deterrence

9-10. Sustained Army force presence promotes a secure environment in which diplomatic and economic programs designed to reduce the causes of instability can flourish. Presence can take the form of forward basing, forward deploying, or pre-positioning assets. Army forces can establish and maintain a credible presence as long as the NCA direct. Army force presence, as part of a TEP, often keeps unstable situations from escalating into war.

9-11. Army forces are the cornerstone of theater deterrence. The sustained presence of strong, capable ground forces is the most visible sign of US commitment—to allies and adversaries alike. However, if deterrence fails, committed forces must be agile enough to transition to combat operations. Ideally, deterrent forces should be able to conduct decisive operations immediately. However, if committed forces lack the combat power to conduct decisive operations, they conduct shaping operations while additional forces deploy.

Ongoing Deterrence^{3/4} Forward Presence in Korea

The demilitarized zone that separates the Republic of Korea from North Korea remains the most densely armed space in the world. As part of a joint and multinational team, Army forces maintain stability through forward presence. To deter aggression, Republic of Korea and US forces prepare to fight and defeat any North Korean attack. Army forces include a numbered army headquarters with active and reserve component representatives, an infantry division, two aviation brigades, a Patriot air defense artillery battalion, and combat support and combat service support units. Annually, during exercise Ulchi Focus Lens, ROK and US forces use enhanced simulation methods to rehearse the theater defense campaign plan. Commanders and staffs have the opportunity to practice integrating forward-based forces with reinforcing units. Through forward presence, Army forces in Korea represent US intentions to deter war.

CHARACTERISTICS OF STABILITY OPERATIONS

9-12. Army forces conduct stability operations in a dynamic environment. Stability operations are normally nonlinear and often conducted in noncontiguous areas of operations (AOs). They are often time- and manpower-intensive. Commanders analyze each mission and adapt the operational framework, elements of operational design, and factors of METT-TC to fit the situation. They often use logical lines of operation to visualize an operation and describe it in terms of decisive, shaping, and sustaining operations. However, determining the military actions necessary to achieve the desired political end state can be

more challenging than in situations requiring offensive and defensive operations; achieving the end state may be just as difficult.

9-13. During all operations, commanders constantly assess the situation in terms of the application and interrelation of the factors of METT-TC. However, stability operations often require commanders to apply METT-TC differently than they would when conducting offensive and defensive operations. The “enemy,” for example, may be a set of ambiguous threats and potential adversaries. Even the mission may change as the situation becomes less or more stable. A mission can be as simple as conducting a briefing to host nation forces in a military-to military-exchange or as difficult as conducting combat operations to accomplish a peace enforcement mission. Stability may be threatened for a number of reasons, and an enemy may be difficult to define or isolate. Depending upon the progress of the operation, the complexity of the mission may change quickly.

9-14. Different factors may be important when analyzing the terrain and the troops and support available in stability operations. What constitutes key terrain may be based more on political and social considerations than physical features of the landscape. The troops assigned or available to a commander could include nontraditional assets, such as host nation police units, contracted interpreters and laborers, or multinational forces. The level of integration and cohesion of a force composed of diverse assets is a key consideration for mission success.

9-15. Time considerations normally are substantially different in stability operations. The goals of a stability operation may not be achievable in the short term. Success often requires perseverance, a long-term commitment to solving the real problem. The achievement of these goals may take years. Conversely, daily operations may require rapid responses to changing conditions based on unanticipated localized conflict among competing groups. Civil considerations are especially critical in stability operations. The civil population, host nation government, nongovernmental organizations (NGOs), and international organizations can greatly affect achieving stability.

9-16. Stability operations are inherently complex and place great demands on small units. Small unit leaders are required to develop interpersonal skills—such as cultural awareness, negotiating techniques, and critical language phrases—while maintaining warfighting skills. They must also remain calm and exercise good judgment under considerable pressure. Soldiers and units at every level must be flexible and adaptive. Often, stability operations require leaders with the mental and physical agility to shift from noncombat to combat operations and back again.

9-17. Stability operations help restore law and order in unstable areas outside of the US and its territories. However, the mere presence of Army forces does not guarantee stability. Offensive and defensive operations may be necessary to defeat enemies that oppose a stability operation. The ability of Army forces to stabilize a crisis is directly related to their perceived ability to attack and defend as necessary.

TYPES OF STABILITY OPERATIONS

9-18. Army forces may conduct stability operations before hostilities, in crises, during hostilities, and after hostilities. Before hostilities, stability operations focus on deterring or preempting conflict. In a crisis, they may resolve a potential conflict or prevent escalation. During hostilities, they can help keep armed conflict from spreading and assist and encourage partners. Following hostilities, stability operations

can provide a secure environment that allows civil authorities to reassume control. Army forces conduct 10 types of stability operations.

Types of Stability Operations

- Peace operations
- Foreign internal defense
- Security assistance
- Humanitarian and civic assistance
- Support to insurgencies
- Support to counterdrug operations
- Combatting terrorism
- Noncombatant evacuation operations
- Arms control
- Show of force

PEACE OPERATIONS

9-19. Peace operations (PO) encompass peacekeeping operations (PKO) and peace enforcement (PEO) operations conducted to support diplomatic efforts to establish and maintain peace (see JP 3-07.3; FM 3-07.3). Army forces conduct PO to support strategic and policy objectives and their implementing diplomatic activities. Although the US reserves the right to conduct PO unilaterally, it will normally participate in PO under the sponsorship of the United Nations (UN) or another multinational organization.

9-20. As in other operations, commanders and staffs should continually assess the operation and prepare contingency plans. In PO, planning for possible or likely transitions is especially important. Examples include transitioning from a US unilateral operation or multinational coalition to a UN-led coalition, from combat to noncombat operations, and from military to civilian control. Optimally, Army forces should not transition from one PO role to another unless there is a change of mandate or a political decision with appropriate adjustments to force structure, rules of engagement (ROE), and other aspects of the mission.

Peacekeeping Operations

9-21. PKO are undertaken with the consent of all major parties to a dispute. They are designed to monitor and facilitate implementation of cease fire, truce, or other such agreements, and to support diplomatic efforts to reach long-term political settlements (see JP 3-07.3; FM 3-07; FM 3-07.3). The ongoing multinational force observer operation in the Sinai Peninsula is an example of a successful PKO. PKO usually involve observing, monitoring, or supervising and assisting parties to a dispute. To achieve objectives, Army forces conducting PKO rely on the legitimacy acknowledged by all major belligerents and international or regional organizations. They use or threaten force only in self-defense or as a last resort. Information superiority is extremely important during PKO. Information superiority supports force protection, situational understanding, and subordinate PKO-related efforts.

Stability Mission at Brcko

On 28 August 1997, US soldiers demonstrated considerable restraint during riots at Brcko, Bosnia. Early that day, forces loyal to Bosnian President Biljana Plavsic attempted to take control of local police stations and media centers. In the process, they clashed with supporters of suspected war criminal Radovan Karadzic. Soldiers from Task Force (TF) Eagle, part of the North Atlantic Treaty Organization Stabilization Force, arrived on the scene to preempt violence and protect UN civilian agencies and international police. While Karadzic's supporters looted the UN police station, other rioters assaulted International Police Task Force (IPTF) members and damaged 100 UN vehicles. The soldiers quickly moved through the agitated crowd to protect IPTF officers and UN property. The pro-Karadzic crowd surrounded the soldiers, threatening to kill them for allegedly taking sides with President Plavsic. Rioters attacked US soldiers with Molotov cocktails, nail-studded boards, rocks, and bricks. They broke the nose of one soldier and stabbed another in the arm. Army leaders ordered their soldiers not to fire on the frenzied crowd. Instead, Stabilization Force helicopters dropped tear gas to disperse the rioters. US forces then secured the wounded soldiers and police officers. The well-trained soldiers and leaders of TF Eagle exhibited disciplined, appropriate restraint under politically charged circumstances.

Peace Enforcement Operations

9-22. PEO apply military force, or threaten its use—normally pursuant to international authorization—to compel compliance with resolutions or sanctions designed to maintain or restore peace and order. Unlike PKO, PEO do not require the consent of all parties. PEO maintain or restore peace and support diplomatic efforts to reach a long-term political settlement. Operation Restore Hope in Somalia during 1992-93 was a peace enforcement operation. Army forces assigned a peace enforcement mission must be able to apply sufficient combat power for self-defense and to forcibly accomplish assigned tasks. Units must also be prepared to transition to PKO. PEO normally include one or more of six subordinate operations:

- Forcible separation of belligerents.
- Establishment and supervision of protected areas.
- Sanction and exclusion zone enforcement.
- Movement denial and guarantee.
- Restoration and maintenance of order.
- Protection of humanitarian assistance.

Operations in Support of Diplomatic Efforts

9-23. Army forces support diplomatic efforts to establish peace and order before, during, and after conflicts. These operations include preventive diplomacy, peacemaking, and peace building (see JP 3-07.3). For example, Army forces support *preventive diplomacy* by conducting preventive deployments or shows of force as part of efforts to deter conflict. Support to *peacemaking* operations often includes military-to-military contacts, exercises, peacetime deployments, and

security assistance. Army forces support to *peace building* involves the same activities as longer-term foreign internal defense (FID) operations. Military support of diplomatic activities improves the chances for success by lending credibility to diplomatic actions and demonstrating the resolve to achieve viable political settlements.

FOREIGN INTERNAL DEFENSE

9-24. FID is participation by civilian and military agencies of one government in programs taken by another government to free and protect its society from subversion, lawlessness, and insurgency (see JP 3-07.1; FM 3-07). It involves all elements of national power and can occur across the range of military operations. FID is a primary program that supports friendly nations operating against or threatened by hostile elements. It promotes stability by helping a host nation establish and preserve institutions and facilities responsive to its people's needs. Army forces participating in FID normally advise and assist host nation forces conducting operations. FID is also a specified and significant mission for selected Army special operations forces (ARSOF) (see FM 3-05). However, FID requires joint planning, preparation, and execution to ensure the efforts of all service and functional components are mutually supportive and focused. The categories of FID operations are—

- Indirect support.
- Direct support (not involving combat operations).
- Combat operations to support host nation efforts.

Indirect Support

9-25. Indirect support emphasizes host nation self-sufficiency and builds strong national infrastructures through economic and military capabilities. Examples include security assistance programs, multinational exercises, and exchange programs. Indirect support reinforces host government legitimacy and primacy in addressing internal problems (see JP 3-07.1).

Direct Support (Not Involving Combat Operations)

9-26. Direct support (not involving combat operations) uses US forces to provide direct assistance to the host nation civilian populace or military. Direct support includes civil-military operations (CMO), intelligence and communications sharing, and logistics. Direct support does not usually involve transferring arms and equipment, or training local military forces (see JP 3-07.1).

Combat Operations

9-27. Combat operations include offensive and defensive operations conducted by US forces to support a host nation fight against insurgents or terrorists. Normally, using US forces in combat operations is a temporary measure. FID operations are closely scrutinized by a variety of audiences, to include the American public, international organizations, and the host nation populace. Hostile propaganda will attempt to exploit the presence of foreign troops to discredit the host government and the US. Poorly executed, direct involvement by the US military can damage the legitimacy and credibility of the host government and host nation security forces. Eventually host nation forces must stabilize the situation and provide security for the populace.

9-28. Most FID activities focus on helping a host nation prevent an active insurgency from developing. If an insurgency already exists or preventive measures fail, FID focuses on eliminating, marginalizing, or reassimilating insurgent elements. The US provides military support to counterinsurgency efforts, recognizing that military power alone cannot achieve lasting success. US military power cannot, and will not, ensure the survival of regimes that fail to meet their people's basic needs. Military programs and US actions promote a secure environment in which to implement programs that eliminate causes of insurgencies and encourage insurgents to rejoin civil society. As with other FID actions, support to a counterinsurgency balances security with economic development to enhance or reestablish stability.

9-29. Army forces conduct support to counterinsurgencies within the context of the US ambassador's country plan and the host nation's internal defense and development strategy. The goal is to integrate all resources—civilian and military, public and private—so that host nation combat operations and development efforts complement each other. The intended result is measurable improvement in the economic, social, and political well-being of those supported. Army forces can also assist in development programs by helping governmental and private agencies provide essential supplies and services.

9-30. Support to counterinsurgencies helps host governments deal with two principal groups: the insurgents and the people. Army forces help host governments protect the people from insurgent violence and separate them from insurgent control. These actions require persuasion, prosecution, and destruction to attack insurgent leadership and organization. The goal is to deny insurgent organizations sources of personnel, materiel, funds, and intelligence. The fundamental cause of insurgent activities is widespread dissatisfaction with standing ethnic, religious, political, social, or economic conditions by some sizable portion of the population. For US military power to be effective in supporting a counterinsurgency, the host government must address or revise its policies toward the disaffected portions of the population. There are few immediate, decisive results in military operations against insurgent forces. When results occur, they are short lived unless the host government acts just as decisively to address the problems that underlie the insurgency.

9-31. Army forces help the host government police, paramilitary, and military forces perform counterinsurgency, area security, or local security operations. They provide advice and assistance in finding, dispersing, capturing, and destroying insurgent forces. Army forces emphasize training national, state, and local forces to perform essential defense functions. Their aim is to provide a secure environment in which development programs can take effect, while respecting the rights and dignity of the people.

SECURITY ASSISTANCE

9-32. Security assistance refers to a group of programs that support US national policies and objectives by providing defense articles, military training, and other defense-related services to foreign nations by grant, loan, credit, or cash sales. Examples of US security assistance programs are Foreign Military Sales, Foreign Military Financing, International Military Education and Training, the Economic Support Fund, and Arms Export Control Act-licensed commercial sales. Army forces support security assistance efforts through military training

teams, maintenance support personnel and training, and related activities such as humanitarian demining operations.

Foreign Internal Defense in El Salvador

From 1979 until the early 1990s, the US recognized Central America as a region of primary security interest. US representatives sought to create lasting democratic change by assisting Latin American countries to revamp domestic policies, processes, and institutions through diplomatic, economic, and military influence. The Reagan administration used diplomacy and economic aid to promote democratic elections, initiate social and economic reforms, and end human rights abuses. A US military group assisted the El Salvadoran army by establishing a facility for basic and advanced military training. The advisors, primarily ARSOF, also served with El Salvadoran units to support small unit training and logistics. The advisors helped the El Salvadoran military become more professional and better organized while advising in the conduct of pacification and counterinsurgency operations against the communist-backed Farabundo Marti National Liberation Front. Army forces supported US interests by creating a crack counterinsurgency force that fought the guerillas to a standstill and established the groundwork for a negotiated settlement.

HUMANITARIAN AND CIVIC ASSISTANCE

9-33. Humanitarian and civic assistance (HCA) programs consist of assistance provided in conjunction with military operations and exercises. By law (Title 10 US Code, section 401), HCA are authorized by the secretary of state and planned and appropriated in the Army budget. HCA must enhance the security interests of both the US and host nation and increase the operational readiness of the units and soldiers performing the mission. In contrast to humanitarian and disaster relief conducted under foreign humanitarian assistance operations, HCA are planned activities with specific budget limitations. HCA are limited to the following categories:

- Medical, dental, and veterinary care for rural areas of a country.
- Construction of rudimentary surface transportation systems.
- Well drilling and construction of basic sanitation facilities.
- Rudimentary construction and repair of public facilities.
- Specified activities related to mine detection and clearance, including education, training, and technical assistance.

SUPPORT TO INSURGENCIES

9-34. On NCA order, Army forces support insurgencies that oppose regimes that threaten US interests or regional stability. While any Army force can be tasked to support an insurgency, ARSOF usually receive these missions. ARSOF training, organization, and regional focus make them well suited for these operations. Army forces supporting insurgencies may provide logistic and training support but normally do not conduct combat operations.

SUPPORT TO COUNTERDRUG OPERATIONS

9-35. In 1986, the president issued National Security Decision Directive 221 declaring drug trafficking a threat to national security. It is also a threat to the stability of many friendly nations. The Army participates in counterdrug operations under provisions of the national drug control strategy. Army forces may be employed in various operations to support other agencies responsible for detecting, disrupting, interdicting, and destroying illicit drugs and the infrastructure (personnel, materiel, and distribution systems) of illicit drug trafficking entities (see JP 3-07.4).

9-36. Army forces always conduct counterdrug operations in support of other US government agencies. These include the Coast Guard, Customs Service, Department of State, Drug Enforcement Agency, and Border Patrol. When conducted inside the US and its territories, they are domestic support operations. When conducted outside the US and its territories, counterdrug operations are considered stability operations. Army forces do not engage in direct action during counterdrug operations. Units that support counterdrug operations comply with US and foreign legal limitations concerning the acquisition of information on civilians and the conduct of law enforcement activities.

Support to Counterdrug Operations

- Detection and monitoring
- Host nation support
- Command, control, communications, and computers
- Intelligence, planning, combat service support, training and manpower support
- Research, development, and acquisition
- Reconnaissance

COMBATTING TERRORISM

9-37. Terrorism is the calculated use of unlawful violence or threat of unlawful violence to inculcate fear. It is intended to coerce or intimidate governments or societies. Terrorists usually pursue political, religious, or ideological goals. Enemies who cannot compete with Army

forces conventionally often turn to terrorist tactics. Terrorist attacks often create a disproportionate effect on even the most capable conventional forces. Terrorist tactics from arson to employing weapons of mass destruction (WMD). Army forces routinely conduct operations to deter or defeat these attacks. Offensively oriented operations are categorized as *counterterrorism*; defensively oriented operations are *antiterrorism*.

Terrorist Tactics

- | | |
|----------------------|------------------|
| • Arson | • Sabotage |
| • Hijacking | • Hoaxes |
| • Maiming | • Bombing |
| • Seizure | • Kidnapping |
| • Assassination | • Hostage taking |
| • Raids and ambushes | • Use of WMD |

Counterterrorism

9-38. Counterterrorism is offensive measures taken to prevent, deter, and respond to terrorism. Army forces participate in the full array of counterterrorism actions, including strikes and raids against terrorist organizations and facilities

outside the US and its territories. Counterterrorism is a specified mission for selected special operations forces that operate under direct control of the NCA or under a combatant command arrangement. Commanders who employ conventional forces against organized terrorist forces operating inside their AO are conducting conventional offensive operations, not counterterrorism operations.

Antiterrorism

9-39. Antiterrorism is defensive measures used to reduce the vulnerability of individuals and property to terrorist attacks, to include limited response and containment by local military forces. Antiterrorism is a consideration for all forces during all types of military operations. Acts of terrorism against US forces may have a strategic impact (see JP 3-07.2; FM 3-07.2). Commanders take the security measures necessary to accomplish the mission and protect the force against terrorism. Soldiers are often most vulnerable during off-duty periods and in recreational locations. Soldiers and families that reside outside protected installations are ideal targets for terrorists. Commanders make every reasonable effort to minimize the vulnerability of their force to murder and hostage taking. Typical antiterrorism actions include—

- Coordinating with local law enforcement.
- Positioning and hardening of facilities.
- Taking physical security actions designed to prevent unauthorized access or approach to facilities.
- Taking crime prevention and physical security actions that prevent theft of weapons, munitions, identification cards, and other materials.
- Establishing policies regarding travel, size of convoys, breaking of routines, host nation interaction, and off-duty restrictions.
- Providing for protection from WMD.

NONCOMBATANT EVACUATION OPERATIONS

9-40. Noncombatant evacuation operations (NEOs) relocate threatened civilian noncombatants from locations in a foreign nation to secure areas (see JP 3-07.5). Normally, these operations involve US citizens whose lives are in danger either from the threat of hostilities or from a natural disaster. They may also include host nation citizens and third country nationals. Army forces, normally as part of a joint task force, conduct NEOs to assist and support the Department of State. Removing noncombatant Americans and others from the threat of being killed or taken hostage provides humanitarian service. Relocating these potential targets expands options available to diplomatic and military authorities.

9-41. NEOs take place in permissive, uncertain, or hostile environments. Ambassadors may initiate a NEO in a permissive environment in anticipation of a crisis. Direct military involvement in these evacuations is usually not required. NEOs supported by the military are normally initiated when the local situation has deteriorated, and the security of the evacuees is uncertain or the environment is hostile. These types of NEOs are usually conducted with minimal warning. Often American lives are in immediate danger.

9-42. NEOs can be conducted as a prelude to combat actions, as part of deterrent actions, or as part of a PO. Most often, evacuation force commanders have little influence over the local situation. They may not have the authority to use military measures to preempt hostile actions, yet must be prepared to protect the evacuees and defend the force. The imminent threat may come from hostile forces, general lawlessness, dangerous environmental conditions, or a combination of all three. Correctly appraising the threat and the political-military environment in which forces operate is key to NEO planning.

ARMS CONTROL

9-43. Army forces normally conduct arms control operations to support arms control treaties and enforcement agencies. Army forces can assist in locating, seizing, and destroying WMD after hostilities, as occurred after Operation Desert

Conventional Arms Control Operations^{3/4} Task Force Eagle in Bosnia

During implementation and sustainment force operations in Bosnia, Army forces belonging to Task Force Eagle and operating under the authority of the Dayton Accords performed arms control operations. Soldiers monitored and inspected numerous weapons storage sites throughout the Task Force Eagle AO to ensure compliance with Annex 1A and its stipulations that the parties withdraw weapons and forces to cantonments and barracks areas.

Storm. Other actions include escorting deliveries of weapons and material (such as enriched uranium) to preclude loss or unauthorized use, inspecting and monitoring production and storage facilities, and training foreign forces to secure weapons and facilities.

9-44. Army forces may conduct arms control to prevent escalation of a conflict and reduce instability. This can include mandated disarming of belligerents as part of a PO. Collecting, storing, and destroying conventional munitions and weapons systems can deter belligerents from resuming hostilities. Some Army force capabilities, including engineering and explosive ordinance disposal, are well suited to these operations.

SHOW OF FORCE

9-45. The US conducts shows of force for three reasons: to bolster and reassure allies, deter potential aggressors, and gain or increase influence. These shows of force are designated as flexible deterrent options. Shows of force are designed to demonstrate a credible and specific threat to an aggressor or potential aggressor. The presence of powerful and capable forces signals

A *show of force* is an operation designed to demonstrate US resolve, which involves increased visibility of US deployed forces in an attempt to defuse a specific situation, that if allowed to continue, may be detrimental to US interests or national objectives.

to potential aggressors the political will to use force. Combatant commanders may establish force deployment options in contingency plans.

9-46. For Army forces, show of force operations usually involve the deployment or buildup of forces, an increase in readiness and activity of designated forces, or a demonstration of operational capabilities by forces already in the region. An effective show of force must be demonstrably mission capable and sustainable. Although actual combat is not desired, shows of force can rapidly and unexpectedly escalate. Units assigned show of force missions assume that combat is probable and prepare accordingly. All actions ordinarily associated with the projection of a force to conduct combat operations pertain to show of force deployments.

CONSIDERATIONS FOR STABILITY OPERATIONS

9-47. Conducting stability operations is identical to conducting offensive, defensive, and support operations. While each stability operation is different, the visualize-describe-direct process, military decision making process, and troop leading procedures apply. The following considerations supplement those processes and help commanders develop tailored concepts and schemes for stability operations.

Considerations for Stability Operations

- Leverage interagency, joint, and multinational cooperation
- Enhance the capabilities and legitimacy of the host nation
- Understand the potential for unintended consequences of individual and small unit actions
- Display the capability to use force in a nonthreatening manner
- Act decisively to prevent escalation
- Apply force selectively and discriminately

LEVERAGE INTERAGENCY, JOINT, AND MULTINATIONAL COOPERATION

9-48. Unity of effort requires constant coordination with all involved agencies. Stability operations require commanders to adapt to situations where lines of authority and areas of responsibility are unclear. This is important because the military is often the supporting rather than the supported agency. Commanders coordinate and integrate civilian and military activities. Likewise, commanders make their military objectives and operational schemes clear to other agencies. Coordination makes unity of effort and effective integration work in environments where unity of command is not possible. It also lends coherence to the activities of the elements involved.

9-49. Operational and tactical headquarters plan their operations to complement those of governmental and private agencies. Coordinating centers such as civil-military operations centers (CMOCs) accomplish this task. CMOCs include representatives from as many agencies as required. Effective civil-military coordination and cooperation is necessary to mass the effects of all assets, agencies, and forces to accomplish national and multinational objectives. Effective CMO reduce the use of US resources through coordination with host and third nation governmental organizations, NGOs, and international organizations operating in the AO (see JP 3-57; FM 3-57).

ENHANCE THE CAPABILITIES AND LEGITIMACY OF THE HOST NATION

9-50. Army forces consciously endeavor to enhance host nation credibility and legitimacy. They demonstrate the proper respect for host nation government, police, and military forces. Host nation military and police forces are integrated into all aspects of every operation. The civil population will closely watch actions by Army forces. Disrespect toward host nation officials or lack of confidence in host nation capabilities by US forces will discredit the host nation and damage the stability effort.

9-51. Commanders must not allow stability issue solutions to become a US responsibility. Within their capabilities, the host nation must take the lead, in both developmental and security activities. When host nation capabilities are inadequate, Army forces enhance them through training, advice, and assistance. Commanders, within the restrictions of international law and US policy, make maximum use of host nation forces and personnel. In any successful stability operation, the host nation—not the US forces supporting it—must ultimately prevail.

9-52. For many stability operations, success demands a long-term investment. Factors that lead to instability or insurgency compound over time. The host nation and its supporters cannot expect to quickly correct years of problems and their consequences. The affected segments of society must see that changes are lasting and underlying problems are being effectively addressed.

UNDERSTAND THE POTENTIAL FOR UNINTENDED CONSEQUENCES OF INDIVIDUAL AND SMALL UNIT ACTIONS

9-53. Given the volatile and politically charged nature of most stability operations, individual and small unit actions can have consequences disproportionate to the level of command or amount of force involved. In some cases, tactical operations and individual actions can have strategic effects. Recognizing and avoiding potential problems requires trained, disciplined, and knowledgeable leaders and soldiers at every level. Every soldier must understand the operational and strategic context of the mission and the potential military, political, and legal consequences of their actions or inaction.

9-54. Stability operations occur in the public view. This includes continuous observation by host nation, domestic, and international populations as well as the media. Knowing this, opponents of stability efforts will seize on relatively minor incidents to achieve strategic advantages. Potentially, a single act of indiscipline or rash application of force can undo months and years of disciplined effort. Likewise, actions that are destructive to the natural or cultural environment may introduce negative perceptions that must be overcome.

DISPLAY THE CAPABILITY TO USE FORCE IN A NONTHREATENING MANNER

9-55. Army forces conducting stability operations must be capable of limited combat operations for self-defense. A corollary to being prepared to conduct offensive and defensive operations is the need to display such preparedness in a nonthreatening manner. The intent is to demonstrate strength and resolve without provoking an unintended response. For example, the aim of a show of force is deterrence, not goading or bullying an adversary into an attack.

9-56. Within mission constraints, units display preparedness by routinely conducting combat training. Training should challenge soldiers with situations involving weapons use, levels of force, and ROE. Consistent with operations security demands, commanders make known to all parties the breadth and depth of available resources. It is not prudent to inform potential adversaries of all available Army force capabilities. However, displaying offensive and defensive strength can deter some adversaries from direct confrontation.

Vietnam^{3/4}A Case Study in US Military Involvement

Direct US involvement in Vietnam began in 1954, when the US military assistance advisory group there received French permission to assist in training South Vietnamese soldiers. Over time, US advisors gradually increased their training role. The Americans assumed fuller control over Vietnamese military affairs, transforming the Army of the Republic of Vietnam (ARVN) into a US-style force. Vietnamese exercises ended with regimental and division maneuvers, training that removed soldiers from fighting the insurgency. In 1956 the French left Vietnam, and the US continued to emphasize conventional warfighting methods. Special Forces worked with the local populace while conventional US forces increased their influence over the ARVN with the creation of Military Assistance Command–Vietnam. In 1965, the war escalated and US forces assumed greater responsibility for military operations. The majority of South Vietnamese people came to rely on US forces for their protection, eroding their confidence in their own government to provide for their security. US forces intended to support the South Vietnamese, but by significantly increasing their role in defending Vietnam, they undermined Vietnamese government authority and ARVN credibility.

ACT DECISIVELY TO PREVENT ESCALATION

9-57. The nature of stability operations may limit the ways and means available to accomplish military objectives. Operational restraints do not necessarily impede the effectiveness of an Army force. Army forces act with speed and determination. Adversaries may perceive hesitation as weakness. Being overcautious can also damage the confidence of the uncommitted populations in the stability effort. Army forces must pursue military objectives energetically and, when necessary, apply military power forcefully. This does not imply that soldiers act with belligerence. Rather, in cases where force is required, commanders ensure that it is applied rapidly and decisively in a manner calculated to end the crisis and deter future confrontations.

APPLY FORCE SELECTIVELY AND DISCRIMINATELY

9-58. An extension of the need to act decisively is the requirement to apply force selectively. Commanders ensure their units apply force in a manner consistent with and adequate to their objectives. They employ combat power appropriate to the mission within prescribed legal and policy limitations. Commanders consider requirements to prevent unnecessary suffering, distinguish between combatants and noncombatants, and minimize the loss of life and damage to property. These considerations constrain or dictate the level of force acceptable. Excessive or arbitrary use of force is never justified. It may lead to the need to

apply ever increasing force to maintain the same degree of order as well as to the loss of sympathy and support of the local populace.

9-59. Conversely, using inadequate force jeopardizes force credibility. Inadequate force emboldens potential adversaries and raises doubts in the minds of protected groups. Operational commanders issue ROE to guide tactical application of combat power. Ordinarily, the commander on the ground is best qualified to determine the required degree of force, consistent with the ROE.

9-60. When available, nonlethal capabilities can provide additional tools to augment, but not replace, the traditional means of deadly force. Nonlethal means expand the number of options for confronting situations where deadly force is not warranted. However, each soldier must retain the capability to immediately apply deadly force for self-defense.

Chapter 10

Support Operations

Instead of thinking about warfighting agencies like command and control, you create a political committee, a civil military operations center, to interface with volunteer organizations. These become the heart of your operations, as opposed to a combat or fire support operations center.

Lieutenant General A. C. Zinni, USMC
Commanding General, I Marine Expeditionary Force

10-1. Support operations use Army forces to assist civil authorities, foreign or domestic, as they prepare for or respond to crises and relieve suffering. In support operations, Army forces provide essential support, services, assets, or specialized resources to help civil authorities deal with situations beyond their capabilities. The purpose of support operations is to meet the immediate needs of designated groups for a limited time, until civil authorities can do so without Army assistance. In extreme or exceptional cases, Army forces may provide relief or assistance directly to those in need. More commonly, Army forces help civil authorities or nongovernmental organizations provide support. Army forces often conduct support operations as stand-alone missions. However, most offensive, defensive, and stability operations require complementary support operations before, during, and after execution.

CONTENTS	
Characteristics of Support Operations.....	10-0
Types of Support Operations.....	10-1
Domestic Support Operations.....	10-1
Foreign Humanitarian Assistance	10-2
The Army's Role in Support	
Operations.....	10-3
Forms of Support Operations.....	10-4
Relief Operations	10-4
Support to Domestic CBRNE	
Consequence Management.....	10-6
Support to Civil Law Enforcement	10-9
Community Assistance	10-11
Considerations for Support Operations.....	10-13

CHARACTERISTICS OF SUPPORT OPERATIONS

10-2. Support operations are usually nonlinear and noncontiguous. Leaders tailor the application of the operational framework, elements of operational design, and METT-TC to fit each situation. Commanders designate the decisive, shaping, and sustaining operations necessary for mission success. However, identifying centers of gravity, decisive points—and even the desired end state—can be more complex and unorthodox than in offensive and defensive operations. When visualizing a support operation, commanders recognize that they may have to define the enemy differently. In support operations, the adversary is often disease, hunger, or the consequences of disaster.

TYPES OF SUPPORT OPERATIONS

10-3. The two types of support operations are domestic support operations (DSO) and foreign humanitarian assistance (FHA). Army forces conduct DSO within, and FHA outside, the US and its territories. Army forces have broader requirements and more significant and extensive obligations in DSO than FHA. Army forces normally conduct FHA operations only in permissive environments. In uncertain and hostile environments, Army forces conduct FHA operations as part of larger stability, offensive, or defensive operations.

Domestic support operations are those activities and measures taken by DOD to foster mutual assistance and support between DOD and any civil government agency in planning or preparedness for, or in the application of resources for response to, the consequences of civil emergencies or attacks, including national security emergencies.

DOMESTIC SUPPORT OPERATIONS

10-4. Army support to DSO supplements the efforts and resources of state and local governments and organizations. A presidential declaration of a major disaster or emergency usually precedes DSO. DSO require extensive coordination and liaison among many organizations—interagency, joint, active component (AC), and reserve component (RC)—as well as with state and local governments. The Federal Response Plan provides a national-level architecture to coordinate the actions of all supporting federal agencies.

10-5. Under the Constitution, civil authorities are responsible for preserving public order and carrying out governmental operations within their jurisdictions—using force if necessary. The Constitution allows the use of Army forces to protect the states against invasion and, upon request of a state, to protect it against domestic violence. Army forces—under joint command— provide the nation with critical capabilities, such as missile defense, necessary to secure and defend the homeland. However, the amended Posse Comitatus Act significantly restricts using federal military forces, to include federalized RC soldiers and units, in law enforcement. It prescribes criminal penalties for using the Army or Air Force to execute laws or to perform civilian law enforcement functions within the US, except as otherwise authorized by the Constitution or Congress. DOD policy extends this prohibition to the Navy and Marine Corps. The Stafford Act also defines and clarifies the role of US military forces in support of domestic civil authorities. Since the law may prohibit certain types of activities during DSO, commanders need a detailed analysis of their legal authorities for each mission.

10-6. The primary reference for military assistance to civil authorities (MACA) is DODD 3025.15. It is wide-ranging, addressing such actions as civil disturbance control, counterdrug activities, combatting terrorism, and law enforcement. The secretary of the Army is the DOD executive agent for MACA. In DSO, Army forces always support civil authorities—local, state, and federal (see JP 3-07.7; FM 3-07).

Refugee Processing^{3/4}A Support Operation

The nature of support operations often requires Army force commanders to report directly to a lead federal agency. In May 1980, the Federal Emergency Management Agency (FEMA) established a Cuban refugee processing center at Fort Indiantown Gap, Pennsylvania. An Army task force consisting of AC and RC forces supported the operation and reported to FEMA.

In 1994, Logistics Task Force 64 supported Department of State and Immigration and Naturalization Service (INS) representatives in establishing refugee camps in Guantanamo Bay, Cuba. Army engineers, military police, medical personnel, logisticians, and legal representatives provided a variety of services—including food, water, laundry, billeting, security, and maintenance—for 14,000 Haitian and 30,000 Cuban refugees.

In August 1999, over 550 Army AC and RC soldiers formed Task Force Provide Refuge, an administrative and logistic organization to care for Kosovo refugees at Fort Dix, New Jersey. The task force commander responded to the INS while receiving, screening, and processing the refugees until they returned home or relocated within the US.

FOREIGN HUMANITARIAN ASSISTANCE

10-7. Army forces usually conduct FHA operations to relieve or reduce the results of natural or manmade disasters (see DODD 5100.46). They also relieve conditions—such as pain, disease, hunger, or privation—that present a serious threat to life or loss of property. Army forces supplement or complement efforts of host nation civil authorities or agencies that provide assistance. FHA is limited in scope and duration. It focuses exclusively on prompt aid to resolve an immediate crisis. Longer-term activities designed to support full recovery and a return to predisaster conditions will normally become part of a combatant commander's theater engagement plan. In such cases, an FHA operation transitions to a stability operation.

10-8. Many FHA and DSO activities, especially those involving relief operations, are similar. Specific legal restrictions apply to US forces operating within the US and its territories. In some cases, similar restrictions apply to US forces conducting FHA. For example, DOD has extended the restrictions of the Posse Comitatus Act to US forces overseas (see DODD 5525.5).

10-9. Army forces execute FHA operations, usually as part of a joint task force (JTF), with the US country team of the affected country. They provide support under appropriate treaties, memorandums of agreement, memorandums of understanding, and US fiscal authority and foreign policy. The US Agency for International Development is the lead US agency for coordinating FHA. Army forces usually conduct FHA operations to support host nation civil authorities and in concert with other civilian agencies—US, international, governmental and private.

JTF Support Hope^{3/4} Foreign Humanitarian Assistance in Africa

On 6 April 1994, an aircraft carrying the presidents of Rwanda and Burundi crashed while landing at Kigali, Rwanda. The Rwandan president's death unleashed ethnic conflict that saw the deaths of between 500,000 and 1 million members of the Tutsi and Hutu ethnic groups. By August 1994, so many Rwandan refugees had fled to neighboring Zaire that they overwhelmed the humanitarian resources there. Thousands of refugees died of malnutrition and cholera, prompting a United Nations response to the crisis.

President Clinton ordered the US European Command (USEUCOM) to assist humanitarian agencies and third nation forces conducting relief operations. USEUCOM activated JTF Support Hope to support the multinational effort. The JTF consisted of 3,000 personnel, including soldiers from the 21st Theater Army Area Command in Germany. US forces provided water distribution and purification systems at Goma, Zaire, and operated an airhead and cargo distribution center at Entebbe, Uganda. They also provided airfield services and logistic support to UN forces. The JTF efforts helped humanitarian relief agencies in Goma to recover. By late August, refugee deaths dropped from 25,000 per day to fewer than 250. As the situation stabilized, civilian agencies assumed terminal operations responsibility. US forces returned to home station on 29 September 1994.

THE ARMY'S ROLE IN SUPPORT OPERATIONS

10-10. The Army is not specifically organized, trained, or equipped for support operations. Army forces are designed and organized for warfighting. However, their warfighting capabilities are particularly suited to DSO and FHA. The Army is a disciplined force with well-established, flexible, and adaptable procedures. Army units have a functional chain of command, reliable communications, and well-trained and well-equipped organizations. They can operate and sustain themselves in austere environments with organic assets. The Army can rapidly move large forces to the affected location using military transportation. Army engineer, military police, medical, transportation, aviation, and civil affairs assets are especially valuable for support operations.

10-11. The special qualities, capabilities, and geographic dispersion of RC units make them especially suitable for DSO. The long-term relationships with state and local officials and the locations of RC units facilitate rapid response. The US Army Reserve has more than 2,000 units in the US, Guam, North Mariana Islands, American Samoa, Virgin Islands, Puerto Rico, and Germany. The Army National Guard (ARNG) has units in 2,700 communities in all 50 states, the District of Columbia, Guam, Puerto Rico, and the Virgin Islands. State control of ARNG units allows them to respond quickly in emergencies. Nonfederalized ARNG units act on orders of their state governor. When in a state supporting or nonfederalized role, the ARNG is not subject to the Posse Comitatus Act.

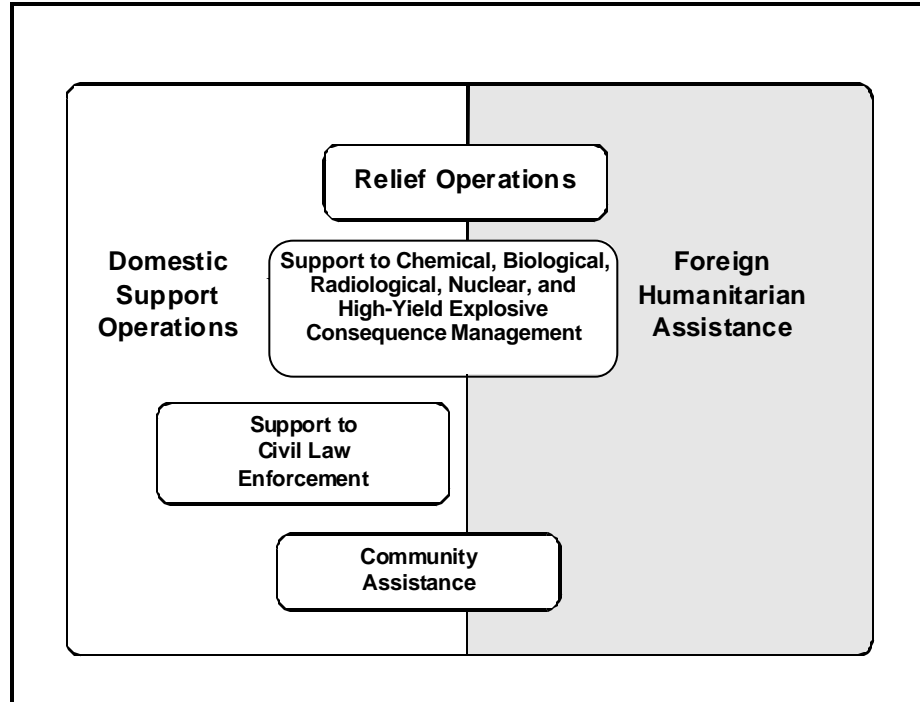

Figure 10-1. Types and Forms of Support Operations

FORMS OF SUPPORT OPERATIONS

10-12. During DSO Army forces perform relief operations, support to chemical, biological, radiological, nuclear, and high-yield explosive consequence management (CBRNE-CM), support to civil law enforcement, and community assistance. In FHA Army forces most often conduct relief operations; however, FHA may also involve support to incidents involving CBRNE and community assistance. Army forces involved in support operations execute overlapping activities (see Figure 10-1).

RELIEF OPERATIONS

10-13. In case of a disaster, state, local, and host nation authorities are responsible for restoring essential services. To support their efforts or those of the lead agency, the National Command Authorities (NCA) can deploy Army forces (see Figure 10-2). Army forces execute similar actions during relief operations under DSO and FHA. Disaster relief focuses on recovery of critical infrastructure after a natural or manmade disaster. Humanitarian relief focuses on the well-being of supported populations. Both normally occur simultaneously.

Critical Relief Functions

- Search and rescue
- Emergency flood control
- Hazard identification
- Food distribution
- Water production, purification, and distribution
- Temporary shelter
- Transportation support
- Fire fighting
- Medical support
- Power generation
- Communications support
- Sanitation

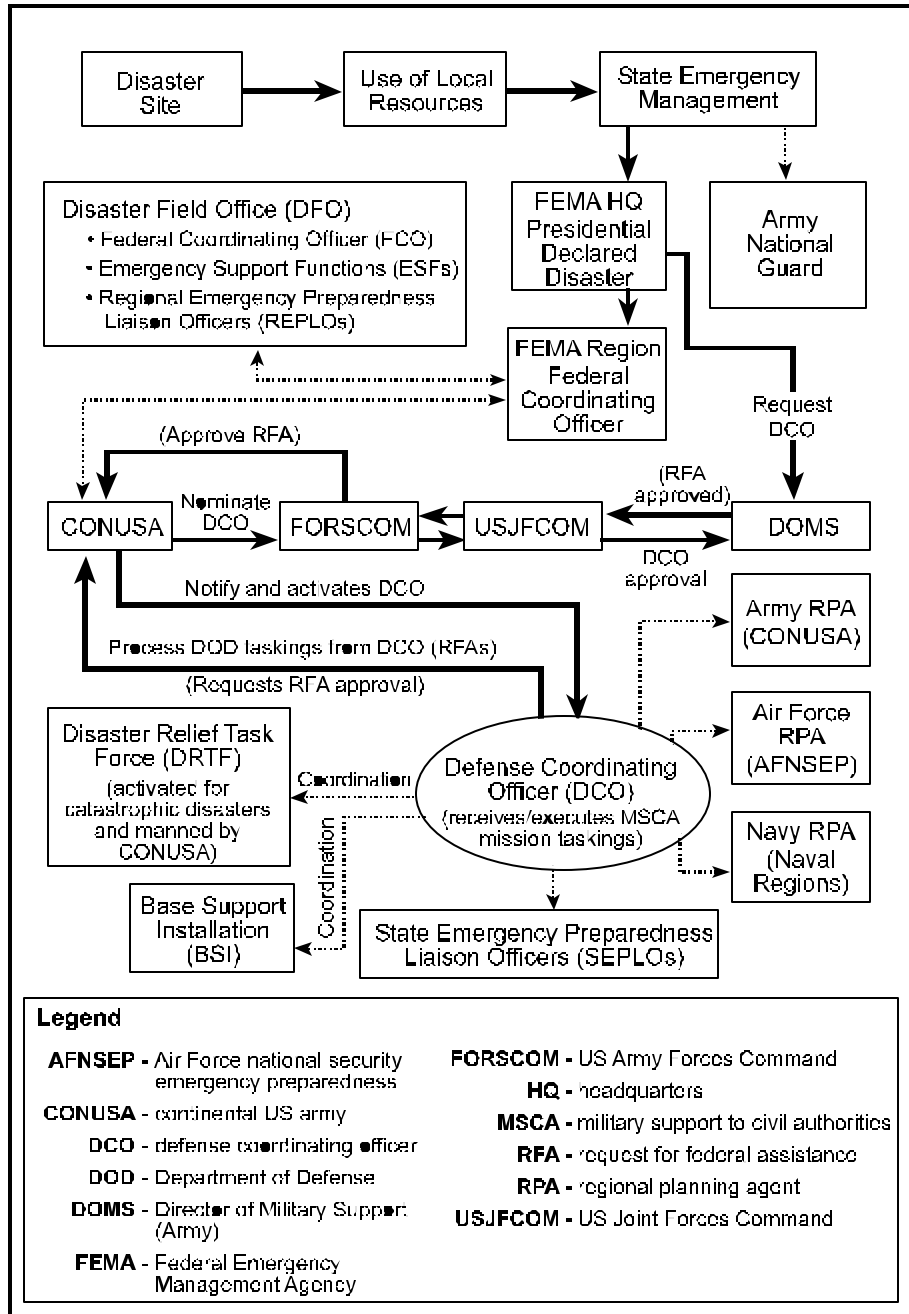

Figure 10-2. Domestic Support Operations in Disaster Relief

Disaster Relief

10-14. Disaster relief restores or recreates essential infrastructure. It includes establishing and maintaining the minimum safe working conditions, less security measures, necessary to protect relief workers and the affected population. (Overseas, Army forces may provide security as part of a stability operation, such as Haiti in 1994. Domestically, Army forces may provide

security as support to civil law enforcement, as was done during the 1996 Atlanta Olympics.) Disaster relief allows effective humanitarian relief and creates the conditions for long-term recovery. It may involve consultation on and provision of emergency medical treatment and evacuation; repairing or demolishing damaged structures; restoring or building bridges, roads, and airfields; and removing debris from supply routes and relief sites. Army engineers are well suited and often critical for disaster relief.

JTF Andrew^{3/4} Disaster Relief in the Continental United States

On 24 August 1992, Hurricane Andrew blasted the southern Florida coast with winds exceeding 160 miles per hour, cutting a 35-mile path of destruction just south of Miami. The hurricane destroyed 65,000 homes, leaving survivors without water, electricity, or telephone service. Heavy debris blocked most roads, making ambulance and fire services difficult and slowing food delivery.

As DOD executive agent for disaster relief, the Department of the Army directed Forces Command and the Second Continental US Army to form JTF Andrew. The 82d Airborne Division alerted, and its lead battalion departed for Florida nine hours later. Forty-eight hours after that, additional soldiers from Fort Bragg, North Carolina, and the 10th Mountain Division from Fort Drum, New York, joined Army advance elements. Within five days, JTF Andrew grew to 9,500 soldiers, 3,400 sailors, 800 Marines, and 1,000 airmen from the active and reserve components.

JTF Andrew worked closely with federal, state, and local agencies to provide housing and meals for disaster victims. It operated 24 support sites that produced 35,000 meals per day. The JTF also established four life support centers that provided tents, medical care, potable drinking water, showers, housing repair materials, and donated items. Army Material Command distributed clothes, diapers, bottled water, and food. Army Medical Command provided combat stress, preventive medicine, veterinary, and health facilities planning augmentation to the 44th Medical Brigade and divisional medical elements. Army forces significantly contributed to the unified action that relieved human suffering and aided victims in rebuilding their communities.

Humanitarian Relief

10-15. Humanitarian relief focuses on lifesaving measures that alleviate the immediate needs of a population in crisis. It often includes providing medical support, food, water, medicine, clothing, blankets, shelter, and heating or cooking fuels. In some cases, it involves transporting affected people from a disaster area. Civilian relief agencies, governmental and nongovernmental, are best suited to provide this type of relief. Army forces conducting humanitarian relief usually facilitate civil relief efforts.

SUPPORT TO DOMESTIC CHEMICAL, BIOLOGICAL, RADIOLOGICAL, NUCLEAR, AND HIGH-YIELD EXPLOSIVE CONSEQUENCE MANAGEMENT

10-16. Chemical, biological, radiological, nuclear, and high-yield explosive (CBRNE) incidents are deliberate or unintentional events involving a

chemical, biological, radiological, nuclear, and high-yield explosive, that produce catastrophic loss of life or property. Army forces assist civil authorities in protecting US territory, population, and infrastructure before an attack by supporting domestic preparedness and protecting critical assets. When directed by DOD, Army forces can respond to a CBRNE incident and deal with the consequences.

Domestic Preparedness

10-17. The National Domestic Preparedness Office, under the Federal Emergency Management Agency (FEMA), orchestrates the national domestic preparedness effort. Army forces have an important role in aiding domestic preparedness efforts at the local, state, and federal level. These efforts strengthen the existing expertise of civil authorities through training. They also provide the expert assistance necessary to respond to nuclear, biological, or chemical incidents. Army forces provide training to enhance state and local emergency response capabilities so they can respond to incidents. An interagency agreement establishes the Department of Justice as domestic preparedness coordinator.

10-18. Under the Department of Justice, the Center for Domestic Preparedness at McClellan, Alabama, trains emergency first responders, emergency management officials, and state and local officials to respond to terrorist acts involving CBRNE. The US Army's Soldier and Biological Chemical Command is engaged in implementing the city training program mandated by *The Defense Against Weapons of Mass Destruction Act of 1996*. Also, the Army Medical Department (AMEDD), in close cooperation with federal, state, and local health organizations, presents courses in the medical management of nuclear, chemical, and biological casualties.

Protection of Critical Assets

10-19. Hostile forces may attack facilities essential to society, the government, and the military. These assaults can disrupt civilian commerce, government operations, and military capabilities. Critical assets include telecommunications, electric power, public health services and facilities, gas and oil, banking and finance, transportation, water, emergency services, and government continuity. DODD 5160.54 identifies specific civil infrastructure assets necessary to conduct military operations. The integrity, availability, survivability, and capability of these assets are vital for conducting full spectrum operations. In conjunction with civil law enforcement, Army forces may protect these assets or temporarily restore lost capability. Army involvement in protecting critical assets complements and leverages related interagency programs and activities.

Response to CBRNE Incidents

10-20. Other government agencies have primary responsibility for responding to domestic CBRNE incidents. Local authorities will be the first to respond to a CBRNE incident. However, Army forces have a key supporting role and can quickly respond when authorized. For example, the ARNG has specialized CBRNE response teams that act as advance parties to facilitate follow-on deployment of other DOD assets. In a permissive overseas environment, the

NCA may make Army assets available to assist a foreign government after a CBRNE incident. Such assistance may be linked to concurrent relief operations. Figure 10-3 illustrates joint and Army command and support relationships in domestic incidents involving CBRNE consequence management.

10-21. The Federal Response Plan is the key plan that affects the use of Army forces in CBRNE incidents. The distinctions between the responsibilities of DOD and other agencies are embedded in federal law, the Federal Response Plan and other federal plans, the Federal Response Plan terrorist incident annex, joint doctrine, and directives.

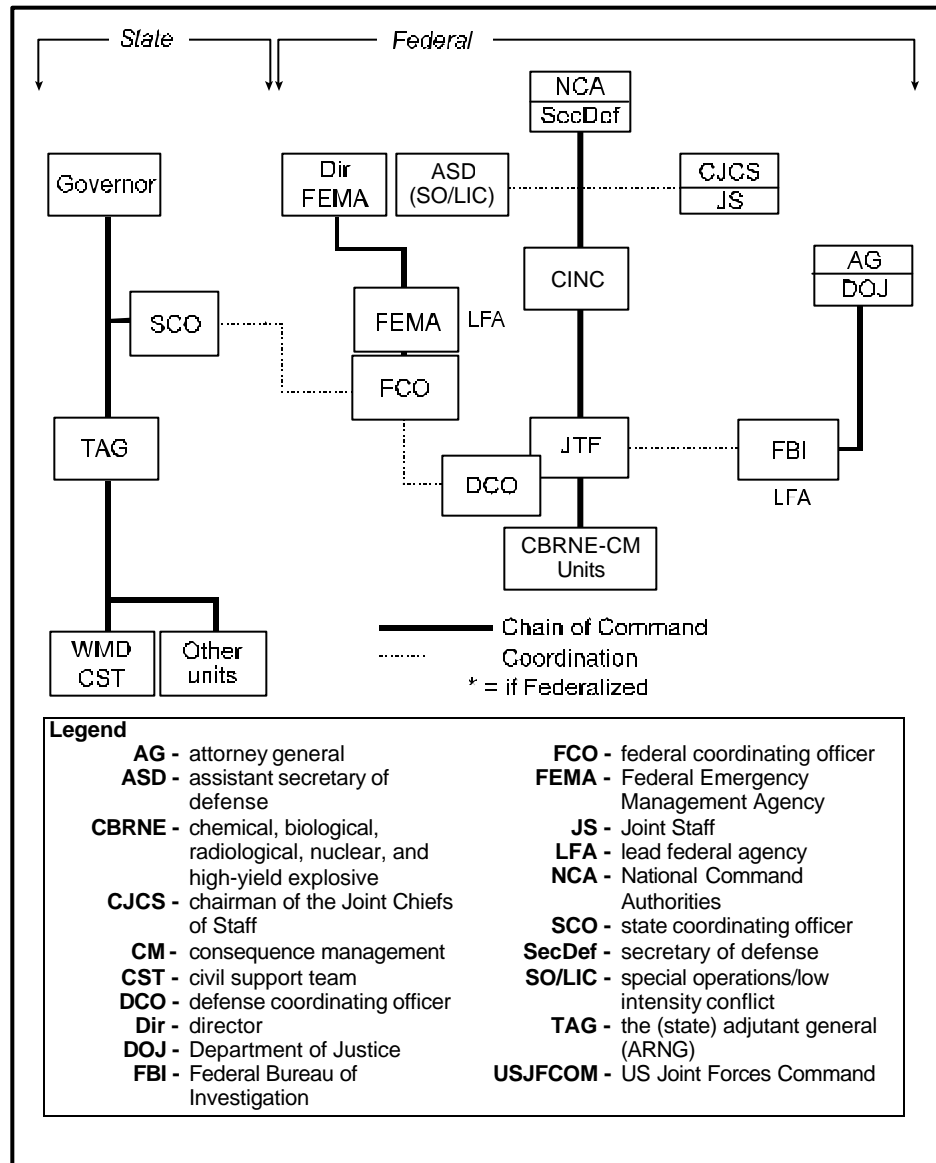

Figure 10-3. Domestic Support Relationships for CBRNE Consequence Management Support

10-22. The resources required to deal with CBRNE incidents differ from those needed during conventional disasters. Mass casualties may require decontamination and a surge of medical resources, to include antidotes, vaccines, and antibiotics. The sudden onset of a large number of casualties may pose public health threats related to food, vectors, water, waste, and mental health. Damage to chemical and industrial plants and secondary hazards such as fires may cause toxic environmental hazards. Mass evacuation may be necessary.

10-23. The Army possesses capabilities suited to respond to CBRNE incidents. Chemical units can detect chemical and biological agents and decontaminate equipment and property. The US Army Medical Command (USAMEDCOM) can provide large-scale medical care. Its experienced, clinicians, planners, and support staffs can furnish assessment, triage, treatment, trauma care, hospitalization, and follow-up care for chemical and biological casualties. It can deploy a field hospital or evacuate victims to fixed facilities. USAMEDCOM maintains special medical augmentation response teams (SMARTs) that rapidly deploy to assist in medical treatment and response. SMARTs focus on chemical and biological casualties, trauma and critical care, stress management, burns, and preventive medical threat assessment.

Consequence Management Activities

- Bomb dogs
- Casualty and medical assistance
- Electrical and structural engineering
- Imagery
- Explosive ordnance disposal
- Linguist support
- Mortuary affairs
- Ground transportation
- Helicopter support
- Public affairs

SUPPORT TO CIVIL LAW ENFORCEMENT

10-24. Support to domestic civil law enforcement involves activities related to counterterrorism, counterdrug operations, military assistance during civil disturbances, and general support. Army support involves providing resources, training, or augmentation. Federal military forces remain under the military chain of command while supporting civil law enforcement. The supported law enforcement agency coordinates Army force activities under appropriate civil laws and interagency agreements. ARNG units in state status can be a particularly useful military resource. They may be able to provide assistance to civil authorities when federal units cannot due to the Posse Comitatus Act.

Support to Counterterrorism

10-25. When the NCA directs, military assets supporting a lead agency may operate with the Department of Justice to provide support to counterterrorism. Army forces may provide transportation, equipment, training, and personnel. When terrorists pose an imminent threat, Army forces may be used to counter it. The demonstrated capability to conduct these operations helps keep US territory from becoming a target.

10-26. Crisis management of a terrorist incident includes measures to resolve a situation and investigate a criminal case for prosecution under federal law. The Federal Bureau of Investigation (FBI) is the lead agency, with responsibility for crisis management in the US. Army forces may provide specialized or technical capabilities to help defuse or resolve a crisis. Support of crisis management includes opening lines of communication for military assistance, evacuating casualties, reconnaissance, and decontaminating or assessing CBRNE. After a terrorist incident, the military may support consequence management activities.

Support to Counterdrug Operations

10-27. The Department of Justice, primarily through the Drug Enforcement Administration, is responsible for enforcing US drug laws. Drug-related crime often affects multiple local, state, and federal jurisdictions. Law enforcement agencies at all levels deal with counterdrug activities. Title 10 US Code (USC) strictly limits Army and federalized ARNG support to counterdrug operations. Title 32 USC, section 112, governs the use of the state-controlled ARNG forces in counterdrug operations.

Title 10 USC prohibits the military from directly participating in arrests, searches, seizures, or other similar activities unless authorized by law.

10-28. Four combatant commands have counterdrug responsibilities: US Southern Command (USSOUTHCOM), US Pacific Command (USPACOM), North American Air Defense Command (NORAD) and USJFCOM. Each commander has dedicated a subordinate organization, in whole or in part, to the counterdrug mission. For example, USJFCOM maintains JTF 6 as a coordinating headquarters for military support to multiagency counterdrug operations in the continental US (see JP 3-07.4).

Civil Disturbance Operations

10-29. The Army assists civil authorities in restoring law and order when state and local law enforcement agencies cannot control civil disturbances. The ARNG is the first military responder during most civil disturbance situations. It usually remains on state active duty status throughout the operation. When the conditions of domestic violence and disorder endanger life and property to the extent that state law enforcement agencies, to include the ARNG, cannot suppress violence and restore law and order, the president may federalize ARNG units under Title 10 USC, Chapter 15. The president may use federalized ARNG and federal forces to restore law and order. Restrictions may be placed on federal military forces, either in the presidential executive order directing their use or through the rules for the use of force outlined in the DOD Civil Disturbance Plan (Garden Plot).

General Support

10-30. Title 10 USC, sections 371–382, and other federal laws allow for additional limited military support to law enforcement agencies. The military may share information and provide equipment, facilities, and other services (see DODD 5525.5). Other exceptions to the Posse Comitatus Act are

contained in the annual DOD Authorization Act, which allows specific types of military support, usually related to the national counterdrug effort.

10-31. DOD may direct Army forces to provide training to federal, state, and local civilian law enforcement agencies. This training may include operation and maintenance of military equipment. Training of federal, state, and local civilian law enforcement officials is provided as follows:

- Military departments and defense agencies may provide expert advice to federal, state, or local law enforcement officials in accordance with Title 10 USC, section 373.
- Assistance is normally limited to situations when using non-DOD personnel is infeasible or impractical from a cost or time perspective and when the assistance will not compromise national security or military preparedness.
- Assistance may not involve DOD personnel in a direct role in a law enforcement operation, except as otherwise authorized by law.
- Assistance must be where there is not a reasonable likelihood of armed confrontation with civilians, except as otherwise authorized by law.

COMMUNITY ASSISTANCE

10-32. Community assistance is a broad range of activities that provide support and maintain a strong connection between the military and civilian communities. Community assistance activities provide effective means of projecting a positive military image, providing training opportunities, and enhancing the relationship between the Army and the American public. They should fulfill community needs that would not otherwise be met.

National-Level Community Assistance Efforts

- Civilian Community Corps
- Science and Technology Academies Reinforcing Basic Aviation and Space Exploration (STARBASE) Program
- Civilian Youth Opportunities Program (Challenge)
- Drug Demand Reduction Programs
- Youth Physical Fitness Clinic Program
- Medical Readiness Program
- Military Assistance to Safety and Traffic (MAST) Program

10-33. Community assistance activities can enhance individual and unit combat readiness. Projects should exercise individual soldier skills, encourage teamwork, and challenge leader planning and coordination skills. They should result in measurable accomplishments and increase soldier proficiency. Commanders of forward-deployed Army units may apply these concepts to foster or establish relationships with host nation communities.

10-34. Community assistance at the national level enhances cooperation between the Army and the American people. National efforts take advantage of the technical, vocational, and group skills of military professionals. They supplement programs available from the civil sector and other government agencies. The Army's involvement focuses on economic and social issues with

long-term national security implications. They provide opportunities for the Army to contribute to the growth and welfare of the nation, improving its perception of the military. Army and DOD regulations provide guidance on national-level programs.

10-35. The Army has extensive national-level responsibilities related to public works maintenance and management. The Department of the Army exercises its federal engineering executive oversight responsibilities through the US Army Corps of Engineers. The Corps of Engineers manages much of the nation's public works infrastructure. Executed principally, but not solely, through the Civil Works Directorate, this military organization integrates complex federal, state, and local regulations and policies governing the national infrastructure. These include the national waterways, environmental remediation and recovery operations, real estate, disaster recovery operations, and general project management functions.

10-36. Efforts at the state and local levels also improve community perception of the Army. Community assistance varies widely, ranging from individual soldier involvement to full installation participation. An installation or organization can enter agreements with the local community to provide critical services not otherwise available, augment community services unable to meet demand, or ensure that emergency services are available in the shortest possible time.

Sample Critical Services

- Air ambulance support
- Search and rescue
- Firefighting capability
- Explosive ordnance disposal
- Emergency or broad-based medical care
- Wildlife and domestic animal management
- Assistance in safety and traffic control
- Emergency snow removal
- Temporary supplemental housing for the displaced or disadvantaged

10-37. Army participation in public events, memorials, and exhibits allows interaction between soldiers and the local community. This contact communicates Army professionalism, readiness, and standards. Individual soldiers serve as representatives and role models, promote and inspire patriotism, and generate interest in the Army. Increased public awareness enhances the Army's reputation and secures the American people's confidence.

10-38. Laws, regulations, and policies limit Army participation in community assistance activities. Commanders consider the objective and purpose of an activity when deciding whether to approve it. They also consider authorized limits of Army participation. Commanders ensure that their initiatives do not compete with local resources or services and will not result in reimbursement in any form. Commanders also avoid providing assistance and support to one segment of a community that cannot also be provided to others. Actions that appear to benefit a particular group can foster perceptions of bias or partisanship. Ideally, support should be provided only to events and activities of common interest and benefit across the community.

CONSIDERATIONS FOR SUPPORT OPERATIONS

10-39. Although each support operation is different, the visualization process, military decision making process, and troop leading procedures apply. The following considerations supplement those processes and can help commanders develop tailored concepts for support operations.

PROVIDE ESSENTIAL SUPPORT TO THE LARGEST NUMBER OF PEOPLE

10-40. The principle commanders use to prioritize missions and allocate support is, essential support to the largest number. Commanders allocate finite resources to achieve the greatest possible good. Initial efforts usually focus on restoring vital services: food and water distribution, medical aid, power generation, search and rescue, firefighting, and community relations. It may be necessary to complete a lower priority task before accomplishing a higher priority one. For example, Army forces may have to restore limited electrical services before restoring hospital emergency rooms and shelter operations.

10-41. Commanders assess requirements to determine how and where to apply limited assets to benefit the most people. In some cases, warfighting reconnaissance capabilities and techniques can be used. For example, unmanned aerial vehicles can survey relief routes and locate civilian refugee groups. Civil affairs or dedicated disaster assessment teams, as well as inter-agency, host nation, and nongovernmental organization sources, can reinforce and supplement standard information collection methods. Combining traditional and nontraditional means of collecting information allows commanders to obtain a clear understanding of the situation and adjust plans accordingly.

COORDINATE ACTIONS WITH OTHER AGENCIES

10-42. DSO and FHA operations are typically joint and interagency; FHA operations are also multinational. The potential for duplicating effort and working at cross-purposes is high. Unity of effort requires, at least, a common understanding of purposes and direction among all agencies. Ensuring unity of effort and efficient resource use requires constant coordination. In FHA operations, Army forces enhance unity of effort by establishing a civil-military operations center. In DSO, they provide liaison elements, planning support, advisors, and technical experts to the lead agency. Through these contacts, commanders determine where their objectives and plans complement or conflict with those of other agencies. Each participant's capabilities will be in constant demand.

ESTABLISH MEASURES OF EFFECTIVENESS

10-43. With supported agencies and governments, commanders establish measures of effectiveness to gauge mission accomplishment. Measures of effectiveness focus on the condition and activity of those being supported. Those that are discrete, measurable, and link cause and effect help commanders understand and measure progress and success. In famine relief, for example, it may be tempting to measure effectiveness by the gross amount of food delivered. In some cases, this may be an acceptable gauge. However, a better one may be the total nourishment delivered, as measured by the total number of calories delivered per person per day, or the rate of decline of deaths directly attributable to starvation. Measures of effectiveness

depend on the situation and require readjustment as the situation and guidance change.

Measures of Effectiveness^{3/4} Operation Support Hope

Mission statements generally provide goals from which to develop measures of effectiveness. The first and most urgent task facing planners for Operation Support Hope in Rwanda, July 1994, was the US Commander in Chief, Europe, directive to “stop the dying.” Initial action focused on the massive refugee deaths from cholera around Goma, Zaire. The JTF commander decided to measure US effectiveness by whether refugee camp death rates dropped to the level the UN determined was consistent with “normal” camp operations. A related mission requirement was to open Kigali airfield for 24-hour operations; success was measured by statistical data that showed the surge in airfield use and cargo throughput after US forces arrived. Both measures of effectiveness derived from the mission statement were used throughout the operation to communicate progress to all participants.

HAND OVER TO CIVILIAN AGENCIES AS SOON AS FEASIBLE

10-44. The timing and feasibility of transferring control from military to civil authorities depends on mission-specific considerations. The two most important are the ability of civil authorities to resume operations without Army assistance and the need to commit Army forces to other operations. Commanders identify and include other civil considerations as early in the planning process as possible. They continually consider the long-term goals of the civil leadership and communities they assist. While the immediate goal of support operations is relieving hardship and suffering, the ultimate goal is creating conditions necessary for civil follow-on operations. Transferring activities to civil authorities and withdrawing Army forces are positive signals to the supported population and the Army. It indicates that the community has recovered enough for civil agencies to resume control, that life is returning to normal, and that the Army has successfully completed its support mission.

PART FOUR

Enabling Operations

Part Four discusses operational-level enabling operations. Commanders direct enabling operations to support offensive, defensive, stability, and support operations. Enabling operations are usually shaping or sustaining; they may be decisive in some military operations other than war.

Chapter 11 addresses how Army forces conduct operations to gain and maintain information superiority. It describes the necessity for Army forces to be able to see their battlespace, understand the situation in their battlespace, and act before their opponent. It outlines the characteristics of information superiority and the information environment. It discusses the contributors to information superiority: intelligence, surveillance, and reconnaissance operations; information management; and information operations, to include its related activities. It describes the aspects of the operations process important to achieving information superiority. It concludes by outlining the impact of technology on the contributors to information superiority.

Chapter 12 addresses combat service support (CSS). It presents the purpose and characteristics of CSS and lists the CSS functions. It describes the factors that affect conducting CSS operations to support the four types of Army operations. The discussion addresses the support provided by national providers, CSS operations in joint and multinational environments, and the factors affecting operational reach and sustainability. Chapter 12 ends by describing the effect of technology on CSS operations.

Directing enabling operations is an intrinsic function of command and the art of operations. Alone, enabling operations cannot assure success; however, neglecting them can result in mission failure.

Chapter 11

Information Superiority

To guess at the intention of the enemy; to divine his opinion of yourself; to hide from both your intentions and opinion; to mislead him by feigned manoeuvres; to invoke ruses, as well as digested schemes, so as to fight under the best conditions—this is and always was the art of war.

Napoleon

11-1. The side possessing better information and using that information more effectively to gain understanding has a major advantage over its opponent. A force that achieves this advantage and effectively uses it to affect enemy perceptions, attitudes, decisions, and actions has exploited information superiority. **Information superiority is the operational advantage derived from the ability to collect, process, and disseminate an uninterrupted flow of information while exploit-**

ing or denying an adversary's ability to do the same. Commanders exploit information superiority to accomplish missions. Information superiority is not static. During operations, all sides attempt to secure its advantages and deny them to adversaries and enemies. The operational advantages of information superiority can take several forms, ranging from the ability to create a better operational picture and understand it in context, to the ability to shape the environment with offensive information operations (IO).

11-2. At its essence, information superiority is about Army forces being able to see first, understand first, and act first. Army forces cannot develop information superiority if they are constantly reacting to enemy operations. Information superiority requires commanders who are proactive, view information as an element of combat power, trust their subordinates to provide relevant information, and conduct (plan, prepare, execute, and continuously assess) operations accordingly. To achieve information superiority,

CONTENTS

Characteristics of Information Superiority.....	11-3
The Information Environment.....	11-4
Contributors to Information Superiority ...	11-5
Intelligence, Surveillance, and Reconnaissance	11-7
Information Management	11-11
Information Operations.....	11-16
Planning and Preparing to Achieve Information Superiority	11-20
Continuous Coordination	11-21
Information Superiority and Strategic Responsiveness.....	11-21
Information Superiority Execution.....	11-22
Operations in Noncontiguous Areas of Operations.....	11-23
Subordinate Initiative	11-23
The Impact of Technology.....	11-23

commanders synchronize and target information as intensely as they do fires and maneuver. They seek to make better use of their information and information systems than adversaries or enemies do of theirs. These information systems include the analysis, procedures, and training necessary to extract and exploit intelligence and other critical information from raw data, and present it in a form in which it can be quickly understood. Successful commanders are those who see, understand, and then exploit the situation.

CHARACTERISTICS OF INFORMATION SUPERIORITY

11-3. Gaining and exploiting information superiority demands effective doctrine, training, leadership, organization, materiel, and soldiers. It puts a premium on the commander's ability to visualize, describe, and direct operations. Effective use of advanced information systems, procedures, and training allows commanders to achieve and maintain situational understanding. Modern information technologies help commanders lead more effectively and consistently make better decisions than those opposing them.

11-4. Commanders manage their information resources, combine their judgment with the knowledge of their staffs and subordinates, and use information systems to understand their battlespace better than their adversaries or enemies do. Commanders require relevant information about the factors of METT-TC to exercise effective command and control (C2). From the initial warning order to completion of redeployment, Army forces use every means, including force, to acquire that information. At the same time, they attempt to deny adversaries and enemies information about friendly forces and actively degrade their ability to collect, process, store, display, and disseminate information. Effective friendly use of information, complemented with active measures that prevent enemies from using information effectively or countering friendly information use, creates conditions for achieving information superiority. Army forces use the qualitative advantages of information superiority as a springboard for decisive operations.

11-5. The operational and tactical implications of information superiority are profound. Rapid seizure and retention of the initiative becomes the distinguishing characteristic of all operations. Information superiority allows commanders to make better decisions more quickly than their enemies and adversaries. Unable to keep pace, enemies and adversaries must deal with new problems before they can solve current ones. In combat, a rapid tempo—sustained by information superiority—can outpace enemy's ability to make decisions contribute to his destruction. In stability operations and support operations, information superiority helps deploying forces anticipate problems and requirements. It allows commanders to control events and situations earlier and with less force, creating the conditions necessary to achieve the end state.

11-6. Adversaries and enemies pursue their own relative information advantages, very likely in asymmetric ways, while continually attempting to deny information superiority to friendly forces. Because opposing forces constantly adapt and situations continually evolve, information superiority is relative and transitory. Absolute information superiority is not possible. Commanders

assess the quality of their information against their decision making requirements. Against that assessment, they estimate the quality of the enemy's operational picture. Commanders avoid any complacency associated with relative levels of military technology. They are aware that their enemy may, by chance or countermeasures, uncover the sources of friendly informational advantage, block them, or use them to deceive.

11-7. Commanders recognize that unless they envision and direct operations designed to achieve and maintain information superiority, they may lose it. Commanders exploit any advantages in information capability and intelligence to increase the effects of combat power. They constantly seek to improve their situational understanding and to assess that of their enemy. They know that losing information superiority may result in losing the initiative.

Nations do not go to war because they think war is safe. They go to war because they think they will win.

Richard M. Swain
Lucky War

THE INFORMATION ENVIRONMENT

11-8. The information environment is the aggregate of individuals, organizations, or systems that collect, process, or disseminate information; also included is the information itself. The climate, terrain, and weapons effects (such as electromagnetic pulse or blackout) affect the information environment but are not part of it. The information environment includes the C2 systems of friendly and enemy forces and those of other organizations and groups. Commanders consider the explosive growth of information and the pervasive nature of the information environment when they visualize an operation. They include that part of the information environment that affects their operation in their battlespace.

11-9. Most of the information environment is not under military control, adding to the challenges commanders face. While they cannot control the entire information environment, they must be prepared to operate within it. Interaction with the information environment increases the complexity of Army operations. More than ever, commanders consider how factors outside their area of operations (AO) may affect their operations. IO often requires coordination with governmental and nongovernmental agencies. Legal limitations on IO vary according to the situation. This interaction may affect the impact of tactics on operations and strategy. Military actions that are tactically or operationally insignificant may influence strategy, or even national policy, when highlighted by the media. Therefore, operational commanders consider more than the military conditions of the end state of a campaign. They consider the comprehensive diplomatic, political, and social aspects of it as well.

11-10. Army forces increasingly rely on the unrestricted use of the information environment. Commanders and staffs need to understand its effects on operations and develop C2 systems that support their operational needs and intelligence requirements. Distance has little meaning in the information environment. Army information systems are "in contact" with enemy information systems before any operation starts. They remain in contact after the

operation ends. Commanders understand that there is no sanctuary for friendly information. Before Army forces arrive in theater, the battle for information superiority begins. Commanders and staff conduct operations accordingly.

Information Superiority in the Gulf

In the opinion of many observers, the Gulf War emphasized integrating information systems, operations, and management in ways that heralded a new form of warfare. Air operations struck C2 nodes throughout Iraq and occupied Kuwait, disabling the air defense network and slowing operational and tactical response. Until the air operation started, Third Army restricted preparations to areas well south of the border. Under cover of intense air bombardment, Saudi and French units secured areas along the border while the powerful US forces shifted west. Even as the Third Army's VII and XVIII Corps moved into attack positions, the US Central Command conducted military deception operations at sea and on land, culminating with the feint by 1st Cavalry Division in the Wadi al-Batin area.

As the ground offensive neared, tactical reconnaissance and surveillance confirmed that the Iraqi Army had its right flank exposed to the west of Kuwait. Special Operations Forces and tactical air reconnaissance complemented these efforts. By 23 February 1991, both corps had secured the border area and extended ground and air reconnaissance well inside Iraq. Intense air attacks fixed and decimated the Iraqi army. The Marine deception and 1st Cavalry Division feint continued to draw Iraqi attention eastward. Third Army moved to attack positions west of the Wadi al-Batin to exploit the Iraqi mistake. At 0400 hours on 24 February 1991, coalition ground forces struck into Kuwait and Iraq. They ended their offensive four days later, having decisively defeated the once fourth-largest army in the world.

Speaking after the war, LTG S. Bogdanov, Chief of the General Staff Center for Operational and Strategic Studies of the former Soviet Union, stated, "Iraq lost the war before it even began. This was a war of intelligence, electronic warfare, command and control, and counterintelligence. Iraqi troops were blinded and deafened...."

CONTRIBUTORS TO INFORMATION SUPERIORITY

11-11. Commanders direct three interdependent contributors to achieve information superiority (see Figure 11-1, page 11-6):

- Intelligence, surveillance, and reconnaissance (ISR).
- Information management (IM).
- IO (to include related activities).

These contributors enable and complement full spectrum operations. Specific objectives that contribute to information superiority include the following:

- Develop and maintain a comprehensive picture of enemies and adversaries; forecast their likely actions.
- Deny enemies and adversaries information about friendly forces and operations.

- Influence enemy and adversary leader perceptions, plans, actions, and will to oppose friendly forces.
- Influence noncombatants and neutrals to support friendly missions or not to resist friendly activities.
- Inform noncombatant and neutral organizations so they can better support friendly policies, activities, and intentions.
- Protect friendly decision making processes, information, and information systems.
- Continually provide relevant information (including intelligence) to the commander and staff in a useable form.
- Destroy, degrade, disrupt, deny, deceive, and exploit enemy decision making processes, information, and information systems, and influence those of adversaries and others.

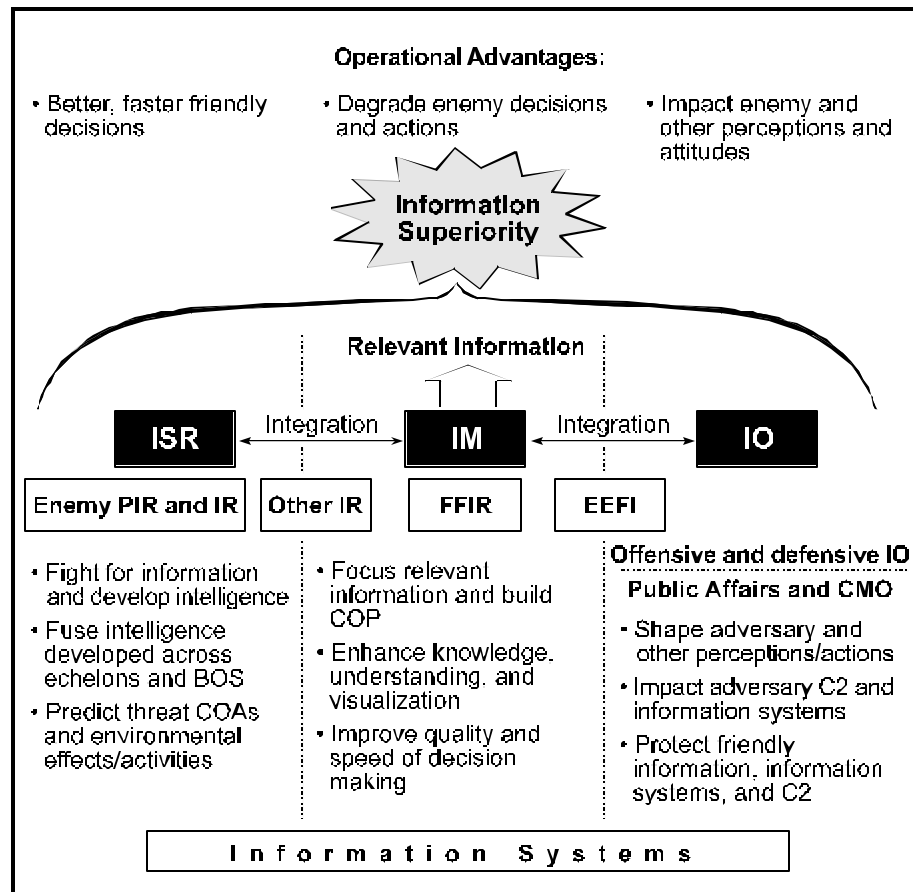

Figure 11-1. Information Superiority

11-12. Commanders wage the struggle for information superiority throughout the information environment, not only in the AO. Superiority in one contributor alone does not ensure information superiority. For example, Army forces may have better IM than a less sophisticated enemy. However, superior intelligence and better security may give the enemy commander more information about Army forces than they have about the enemy. Uncoordinated

actions within single contributors are ineffective. Information superiority results when commanders synchronize all three contributors. Figure 11-2 illustrates the nature of the struggle for information superiority.

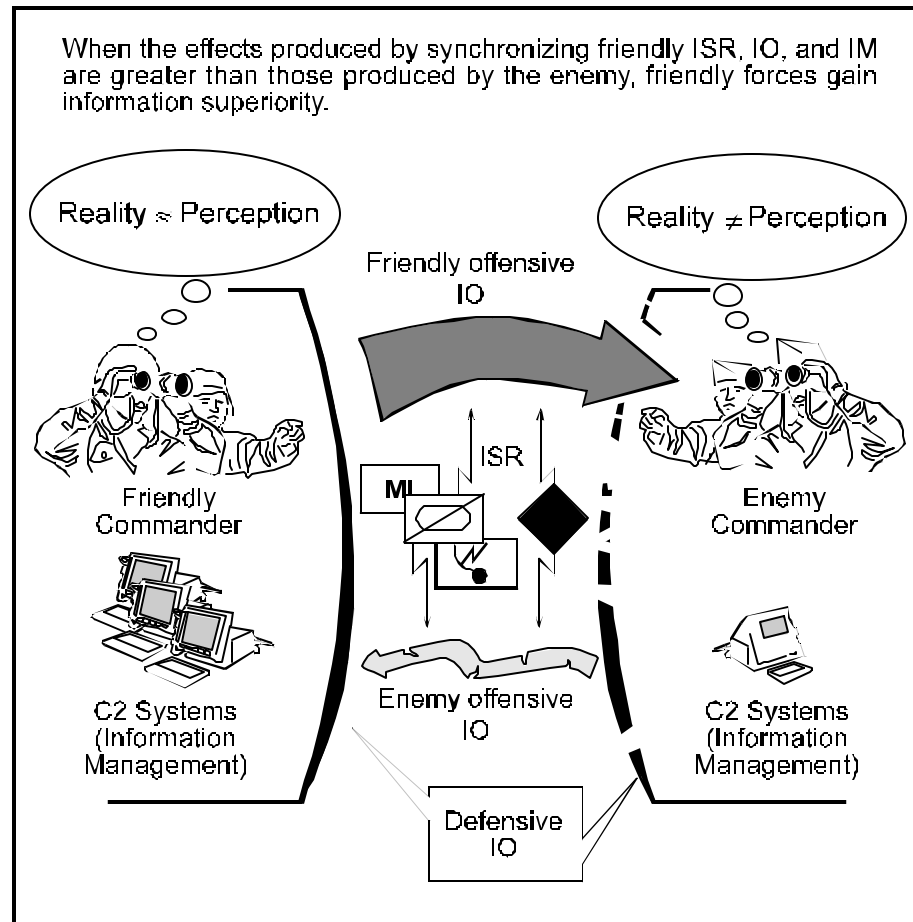

Figure 11-2. Information Operations and Information Superiority

INTELLIGENCE, SURVEILLANCE, AND RECONNAISSANCE

11-13. ISR integration is fundamental to information superiority. Thoroughly integrated ISR operations add many collection sources. ISR integration eliminates unit and functional “stovepipes” for planning, reporting, and processing information and producing intelligence. It provides a common mechanism for all units to conduct ISR operations in a coordinated, synergistic way.

11-14. ISR operations allow units to produce intelligence on the enemy and environment (to include weather, terrain, and civil considerations) necessary to make decisions. This intelligence answers requirements developed throughout the operations process. Timely and accurate intelligence encourages audacity and can facilitate actions that may negate enemy superiority in soldiers and materiel. Normally, timely and accurate intelligence depends on aggressive and continuous reconnaissance and surveillance.

Intelligence

11-15. The complexity of the operational environment requires sharing intelligence from the national level to the tactical level and among headquarters at each level. Analysis is a complex task that requires fusing information and intelligence from each ISR discipline and asset into an all-source product. Analysis is increasingly distributed and collaborative. Analysts who are closest to the

Intelligence is (1) the product resulting from the collection, processing, integration, analysis, evaluation, and interpretation of available information concerning foreign countries or areas; (2) information and knowledge about an adversary obtained through observation, investigation, analysis, or understanding.

point of collection enter data and perform initial processing one time for the entire force. Modern information systems allow analysts to collaborate on the overall analysis without degrading support to their own commanders, regardless of their geographic dispersion. This distributed, collaborative analysis process starts with the initial intelligence preparation of the battlefield (IPB) and continues throughout operations.

11-16. The commander drives the intelligence system. Managing the ISR effort entails—

- **Requirements visibility.** Intelligence personnel use procedures and information systems to monitor and display the status of information requirements.
- **Asset visibility.** Intelligence personnel use procedures and information systems to monitor and display collection asset status, location, and activities.
- **ISR assessment capability.** Intelligence personnel use procedures and information systems to assess the effectiveness of the ISR effort and the operational impact of ISR results (such as its success or gaps in collection), and to task collection assets.

11-17. Intelligence provides critical support to all operations, including IO. It supports planning, decision making, target development, targeting, and protecting the force. It is a continuous process for any operation. Surveillance and reconnaissance are the primary means of collecting information used to produce intelligence. A thorough understanding of joint ISR capabilities allows commanders to prepare complementary collection plans. Surveillance and reconnaissance assets focus primarily on collecting

Intelligence preparation of the battlefield is a systematic approach to analyzing the enemy and environment (for example, weather, terrain, and civil considerations) in a specific geographic area. It integrates enemy doctrine with the weather, terrain, and civil considerations as they relate to the mission and the specific environment. This is done to determine and evaluate enemy capabilities, vulnerabilities, and probable courses of action.

information about the enemy and the environment to satisfy the priority intelligence requirements (PIR). In the end, the art of intelligence and its focus on supporting the commander are more important than any information system. This art includes an understanding of intelligence, analysis, the enemy, operations, and the commander's needs.

11-18. IPB is the first step toward placing an operation in context. It drives the process that commanders and staff use to focus information assets and to integrate surveillance and reconnaissance operations across the AO. IPB provides commanders with information about the enemy and environment, and how these factors affect the operation. In most cases, IPB allows commanders to fill gaps in information about the enemy with informed assessments and predictions. IPB is also the starting point for situational development, which intelligence personnel use to develop the enemy and environment portions of the common operational picture (COP). As such, IPB is important to the commander's visualization. The commander drives IPB, and the entire staff assists the intelligence staff with continuous updates. All staff officers develop, validate, and maintain IPB components relating to their areas of expertise. For example, the engineer contributes and maintains current mobility and countermobility situation overlays.

Surveillance

11-19. Surveillance involves continuously observing an area to collect information. Wide-area and focused surveillance provide valuable information.

Surveillance is the systematic observation of aerospace, surface or subsurface areas, places, persons, or things, by visual, aural, electronic, photographic or other means.

11-20. Army forces at all echelons receive intelligence based on information from national, joint, Army, and commercial surveillance systems. National and theater surveillance systems focus on information requirements for combatant commanders and provide information to all services for theater-wide operations. Continuous theater surveillance helps analysts determine the location and approximate dispositions of enemy land forces. When available, near real-time surveillance platforms—such as the joint surveillance, target attack radar system (JSTARS)—provide moving target indicators. Additionally, long-range surveillance units can provide extremely accurate and valuable information.

11-21. Although the US may enjoy an advantage in surveillance assets, commanders should assume that enemies also have adequate surveillance means. For example, an enemy may purchase high-resolution imagery from commercial space-based systems. Alternatively, the local populace may report Army force actions through the civilian police to enemy intelligence agencies.

Reconnaissance

11-22. Reconnaissance collects information and can validate current intelligence or predictions. Reconnaissance units, unlike other units, are designed to collect information.

11-23. Information collected by means other than reconnaissance has great operational and tactical value. However, those assets may not be able to meet some requirements or collect information with adequate accuracy and level of detail. Operational priorities within the theater may limit ground

Reconnaissance is a mission undertaken to obtain by visual observation or other detection methods, information about the activities and resources of an enemy or potential enemy, or to secure data concerning the meteorological, hydrographic, or geographic characteristics of a particular area.

commanders' ability to task theater surveillance systems. Therefore, Army commanders complement surveillance with aggressive and continuous reconnaissance. Surveillance, in turn, increases the efficiency of and reduces the risk to reconnaissance elements by focusing their operations.

11-24. In some situations, the firepower, flexibility, survivability, and mobility of reconnaissance assets allow them to collect information where other assets cannot. Reconnaissance units obtain information on adversary and potential enemy forces as well as on the characteristics of a particular area. Reconnaissance missions normally precede all operations and begin as early as the situation, political direction, and rules of engagement permit (see FM 5-0). They continue aggressively throughout the operation. Reconnaissance can locate mobile enemy C2 assets, such as command posts, communication nodes, and satellite terminals for neutralization, attack, or destruction. Commanders at all echelons incorporate reconnaissance into the conduct of operations (see FM 3-90).

11-25. Continuous and aggressive reconnaissance does more than collect information. It may also produce effects or prompt enemy actions. The enemy may take forces needed elsewhere to counter friendly reconnaissance efforts. Hostile forces sometimes mistake reconnaissance units for the decisive operation and prematurely expose their dispositions or commit their reserves. Friendly commanders may exploit opportunities revealed by friendly reconnaissance, often using the reconnaissance force as the spearhead. Information from reconnaissance missions allows commanders to refine or change plans and orders, preclude surprises, and save the lives of soldiers.

You can never do too much reconnaissance.

General George S. Patton Jr.
War As I Knew It

11-26. Reconnaissance elements may have to fight for information. However, the purpose of reconnaissance is to gain information through stealth, not initiate combat. Reconnaissance operations that draw significant combat power into unplanned actions not in line with the commander's intent may jeopardize mission accomplishment.

11-27. Commanders integrate ISR missions into a single plan that capitalizes on their different capabilities. They synchronize reconnaissance and surveillance missions that employ maneuver units with both the ISR plan and scheme of maneuver.

INFORMATION MANAGEMENT

11-28. **Information management is the provision of relevant information to the right person at the right time in a usable form to facilitate situational understanding and decision making. It uses procedures and information systems to collect, process, store, display, and disseminate information** (see FM 6-0). IM is far more than technical control of data flowing across networks. It communicates decisions that initiate effective actions to accomplish missions and fuses information from many sources. Successful IM adds meaning to information as it is processed, so decision makers can focus on achieving understanding instead of processing or evaluating information. IM consists of two supporting components: information systems and relevant information.

11-29. Successful IM includes processing. Processing adds meaning to relevant information through progressively higher-level and complex cognitive methods to create a COP. Among other aspects, processing includes lower-level mechanical and mechanistic methods, such as organizing, collating, plotting, and arranging. However, effective processing requires analysis and evaluation (higher-level cognitive methods) to convert information into knowledge and knowledge into understanding. This aspect of processing depends on the insight and flexibility of well-trained and adaptive analysts.

11-30. Commanders and staffs assess the effectiveness of IM by considering how information contributes to lessening the “fog of war.” First, untimely information or unusable data has the same effect as not having the information. It either arrives too late or cannot be understood in time to affect the commander’s decision. Second, incomplete or imprecise information is better than no information. While not perfect, it contributes to the commander’s grasp of the situation and may assist decision making. Finally, irrelevant or inaccurate information is worse than no information. Irrelevant information distracts and delays; inaccurate information may lead to an inappropriate decision. Computers and software cannot make these qualitative distinctions; making them requires soldiers with good judgment.

Information Systems

11-31. **Information systems are the equipment and facilities that collect, process, store, display and disseminate information. These include computers—hardware and software—and communications, as well as policies and procedures for their use.** Information systems are integral components of C2 systems. Effective information systems automatically process, disseminate, and display information according to user requirements. IM centers on commanders and the information relevant to C2. Commanders make the best use of information systems when they determine their information requirements and focus their staffs and organizations on meeting them.

Relevant Information

11-32. **Relevant information is all information of importance to commanders and staffs in the exercise of command and control.** To be relevant, information must be accurate, timely, usable, complete, precise, and reliable. Relevant information provides the answers commanders and staffs

need to successfully conduct operations, that is, all elements necessary to address the factors of METT-TC. The intelligence system, for example, provides intelligence that constitutes relevant information on the enemy, terrain and weather, time available (to the enemy), and civil considerations.

11-33. Relevant information results from assigning meaning to data to assist understanding. Processing changes raw data into information by assigning meaning to it. Analysis and evaluation transform information into knowledge, which is presented to commanders as relevant information. When commanders apply judgment to knowledge, it becomes understanding. Understanding enables making informed decisions with less-than-perfect data. Combined with will, understanding generates effective action.

11-34. Relevant information is perishable. If not delivered and acted upon quickly, it may become outdated (no longer relevant) and distort the commander's situational understanding. Masses of data and information may overwhelm the command post. Without effective IM, critical information will be misrouted, delayed, or buried in routine data and overlooked. Information systems can assist in managing volumes of data, but will not do so unless commanders define their information requirements, tie them to their intent, and update them as execution unfolds.

Categories of Information

11-35. IM narrows the gap between available information and information commanders require. Effective IM facilitates rapid dissemination of relevant information. IM assigns information into four categories: specified requirements, implied requirements, gaps, and distractions.

- **Specified requirements.** Specified requirements are requirements the commander specifically identifies. This information may take the form of facts, estimates, or assumptions.
- **Implied requirements.** Implied requirements are important pieces of information that commanders have not specifically requested. Full spectrum operations may place Army forces in situations that lie outside the commander's experience. Commanders may not know to obtain some elements of information. They may not know that they need a piece of information or may not recognize its importance. Effective staffs develop and recommend these additional information requirements. Commanders encourage intellectual versatility and agility within their staff and examine recommendations carefully.
- **Gaps.** Gaps are elements of information commanders need to achieve situational understanding but do not have. Ideally, analysis identifies gaps and translates them into specified requirements. To fill gaps, commanders and staffs make assumptions, clearly identifying them as such. There may be circumstances when commanders and staffs fail to identify a gap. Such circumstances are especially dangerous, particularly when facing an asymmetric threat. The commander not only does not have a piece of relevant information, but also does not know he needs it. This situation may result in the commander being surprised. Commanders and staffs remain adaptive and examine circumstances as they are, rather than fitting circumstances into preconceived notions.

- **Distractions.** Distractions include information commanders do not need to know but continue to be told. Excessive distractions result in information overload.

11-36. Information is further classified as facts, estimates, and assumptions. *Facts* are information commanders want to know and can know with certainty. A fact must be confirmed or come from a reliable source. *Estimates* and *assumptions* are information commanders want to know but cannot know with certainty. Commanders and staffs must use discipline in separating fact from assumption; otherwise they are vulnerable to deception or risk inaccurate situational understanding. Estimates and assumptions primarily include information about the enemy, the future, or factors over which commanders have little or no control.

11-37. Facts, estimates, and assumptions can be either relevant information or distractions. They are relevant information if the commander both wants and needs to know the information. They are distractions if the commander wants to know but does not need to know the information. Photographs, for example, can be distractions. Unless the commander clearly understands the imagery, demands for photos only clog overloaded information systems. Effective IM filters distractions from relevant information.

Quality of Information

11-38. Sources of information are imperfect and susceptible to distortion and deception. Soldiers processing information use these qualities to evaluate it:

- **Accuracy.** The information conveys the actual situation; in short, it is fact.
- **Timeliness.** The information has not been overtaken by events.
- **Usability.** The information is easily understood or displayed in a format that immediately conveys the meaning.
- **Completeness.** The information contains all required components.
- **Precision.** The information has the required level of detail, no more and no less.
- **Reliability.** The information is trustworthy, uncorrupted, and undistorted.

Effective IM keeps commanders and staffs aware of the quality of their information as they use it to build situational understanding.

Commander's Critical Information Requirements

11-39. Commanders channel information processing by clearly expressing which information is most important. They designate critical information that derives from their intent—the commander's critical information requirements (CCIR). **The commander's critical information requirements are elements of information required by commanders that directly affect decision making and dictate the successful execution of military operations.** The key to effective IM is answering the CCIR.

11-40. When commanders receive a mission, they and their staffs analyze it using the military decision making process. As part of this process, commanders visualize the battlefield and the fight. CCIR are those key elements

of information commanders require to support decisions they anticipate. Information collected to answer the CCIR either confirms the commander's vision of the fight or indicates the need to issue a fragmentary order or execute a branch or sequel. CCIR directly support the commander's vision of the battle—commanders develop them personally. Once articulated, CCIR normally generate two types of supporting information requirements: friendly force information requirements (FFIR) and PIR.

Priority intelligence requirements are those intelligence requirements for which a commander has an anticipated and stated priority in his task of planning and decision making.

Friendly force information requirements are information that the commander and staff need about the forces available for the operation.

11-41. CCIR must be focused enough to generate relevant information. Unfocused requests, such as "I need to know if the enemy moves," may provide data but not much useable information. However, "I need to know when the enemy lead brigade reaches Named Area of Interest 2" or "I need to know if the multinational unit on our right flank advances beyond Phase Line Blue" are examples of CCIR specific enough to focus collection and IM priorities.

Essential Elements of Friendly Information

11-42. Although essential elements of friendly information (EEFI) are not part of the CCIR, they become a commander's priorities when he states them. EEFI help commanders understand what enemy commanders want to know about friendly forces and why (see FM 6-0). They tell commanders what cannot be compromised. For example, a commander may determine that if the enemy discovers the movement of the reserve, the operation is at risk. In this case, the location and movement of the reserve become EEFI. EEFI support defensive IO, and as such may become information requirements. EEFI provide a basis for indirectly assessing the quality of the enemy's situational understanding: if the enemy does not know an element of EEFI, it degrades his situational understanding.

Essential elements of friendly information are the critical aspects of a friendly operation that, if known by the enemy, would subsequently compromise, lead to failure, or limit success of the operation, and therefore must be protected from enemy detection.

Common Operational Picture

11-43. **An operational picture is a single display of relevant information within a commander's area of interest.** By collaborating, sharing, and tailoring relevant information, separate echelons create a COP. **A common operational picture is an operational picture tailored to the user's requirements, based on common data and information shared by more than one command.** The COP is displayed at a scale and level of detail that meets the information needs of the command at a particular

echelon. C2 systems fuse information from a variety of sources, while information systems facilitate its rapid distribution in usable displays that facilitate understanding.

11-44. Different echelons require different information at different levels of precision and detail. The presentation of information in meaningful images assists its assimilation. IM provides relevant information as meaningful displays rather than masses of data. The COP allows collaborative interaction and real-time sharing of information among commanders and staffs without providing them with too much or too little information.

11-45. The Army continues to invest in technologies and develop procedures that increase commanders' ability to understand their battlespace. These modernizing efforts will increase the capability of Army forces to share a full-dimensional, highly accurate COP and rapidly disseminate guidance, orders, and plans. Technological applications that help visualize, illustrate, brief, and rehearse options contribute to a common understanding of the commander's intent and concept of operations. Increasing the speed of analysis, compilation, and communication leaves more time for synthesis—assigning meaning to information and generating potential options.

Situational Understanding

11-46. ***Situational understanding is the product of applying analysis and judgment to the common operational picture to determine the relationships among the factors of METT-TC*** (see FM 6-0). It enhances decision making by identifying opportunities, threats to the force or mission accomplishment, and information gaps. It helps commanders identify enemy options and likely future actions, the probable consequences of proposed friendly actions, and the effects of the environment on both. Situational understanding based on a COP fosters initiative in subordinate commanders by reducing, although not eliminating, uncertainty (see Figure 11-3, page 11-16).

11-47. Situational understanding has limits. It is imperfect, particularly with respect to the enemy situation. It requires constant verification. Situational understanding focuses on the current situation. It can reduce the friction caused by the fog of war. However, achieving accurate situational understanding depends at least as much on human judgment as on machine-processed information—particularly when assessing enemy intent and combat power. Simply having a technologically assisted portrayal of the situation cannot substitute for technical and tactical competence. Additionally, portions of the force will not be modernized for some time. The level of situational understanding between modernized and less modernized units may vary over time. Commanders recognize the disparity between organizations and adjust procedures and subordinate unit missions accordingly.

Information Management in Full Spectrum Operations

11-48. IM is a command responsibility. IM plans establish responsibilities and provide instructions for managing information. The IM plan is the commander's "concept of operations" for handling information. Effective IM plans cover the entire scope of operations. Designated staff elements refine the IM plan and provide overall management of information.

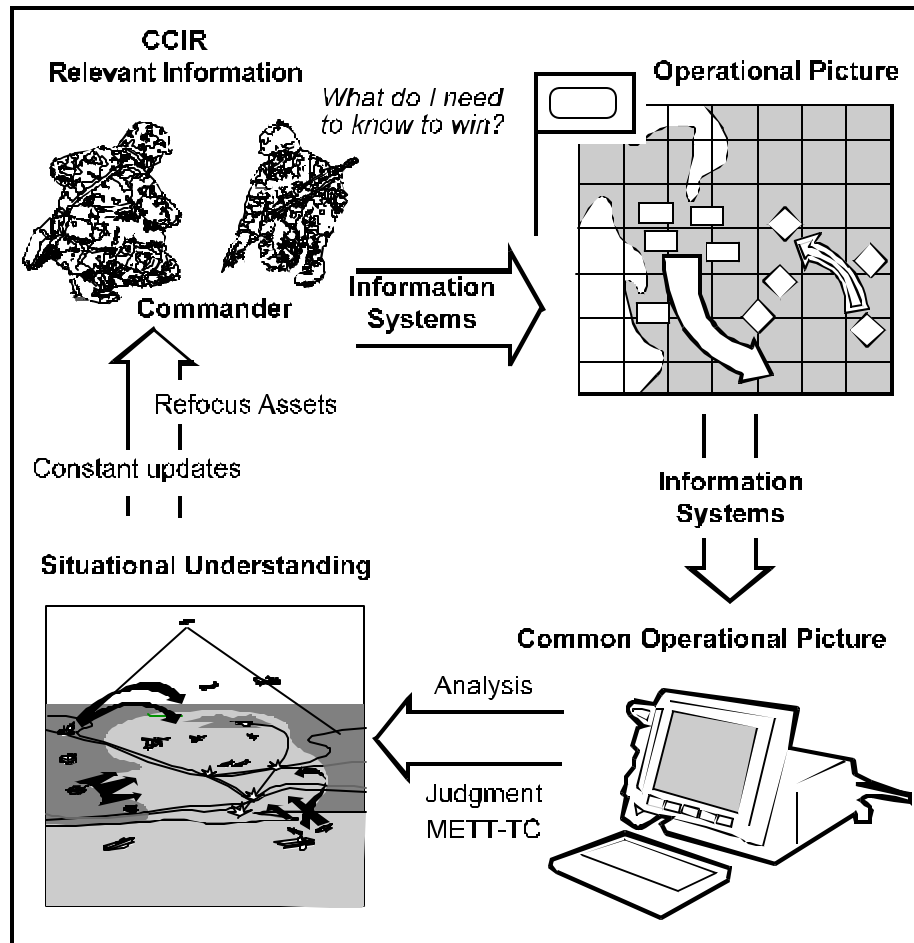

Figure 11-3. Situational Understanding

INFORMATION OPERATIONS

11-49. IO are primarily shaping operations that create and preserve opportunities for decisive operations. IO are both offensive and defensive. Related activities—public affairs and civil-military operations (CMO)—support IO.

11-50. The value of IO is not in their effect on how well an enemy transmits data. Their real value is measured only by their effect on the enemy's ability to execute military actions. Commanders use IO to attack enemy decision making processes, information, and information systems. Effective IO allow commanders to mass effects at decisive points more quickly than the enemy. IO are used to deny, destroy, degrade, disrupt, deceive, exploit, and influence the enemy's ability to exercise C2. To create this effect, friendly forces attempt to influence the enemy's perception of the situation.

Information operations are actions taken to affect adversary, and influence others', decision making processes, information and information systems while protecting one's own information and information systems.

11-51. Similarly, IO and related activities affect the perceptions and attitudes of a host of others in the AO. These include the local population, displaced persons, and civilian leaders. IO are shaping operations that help commanders create favorable conditions for not only decisive operations but also sustaining operations. Commanders use IO and related activities to mitigate the effects of enemy IO, as well as adverse effects stemming from misinformation, rumors, confusion, and apprehension.

11-52. Successful IO require a thorough and detailed IPB. IPB includes information about enemy capabilities, decision making style, and information systems. It also considers the effect of the media and the

attitudes, culture, economy, demographics, politics, and personalities of people in the AO. Successful IO influences the perceptions, decisions, and will of enemies, adversaries, and others in the AO. Its primary goals are to produce a disparity in enemy commanders' minds between reality and their perception of reality and to disrupt their ability to exercise C2 (see FM 3-13).

11-53. Offensive and defensive operations use complementary, reinforcing, and asymmetric effects to attack enemies, influence adversaries and others, and protect friendly forces. On a battlefield where concentrating forces is hazardous, IO can attack enemy C2 systems and undermine enemy capabilities and will to fight. It can reduce friendly vulnerabilities and exploit enemy weaknesses. Where the use of force is restricted or is not a viable option, IO can influence attitudes, reduce commitment to a hostile cause, and convey the willingness to use force without actually employing it. Information used in this manner allows friendly forces to accomplish missions faster, with fewer casualties.

Offensive information operations are the integrated use of assigned and supporting capabilities and activities, mutually supported by intelligence, to affect enemy decision makers or to influence others to achieve or promote specific objectives.

Defensive information operations are the integration and coordination of policies and procedures, operations, personnel, and technology to protect and defend friendly information and information systems. Defensive information operations ensure timely, accurate, and relevant information access while denying adversaries the opportunity to exploit friendly information and information systems for their own purposes.

Offensive Information Operations

11-54. The desired effects of offensive IO are to destroy, degrade, disrupt, deny, deceive, exploit, and influence enemy functions. Concurrently, Army forces employ elements of offensive IO to affect the perceptions of adversaries and others within the AO. Using the elements of IO offensively, Army forces can either prevent the enemy from exercising effective C2 or leverage it to their advantage. Ultimately, IO targets are the human leaders and human decision making processes of adversaries, enemies, and others in the AO.

Defensive Information Operations

11-55. Defensive IO protect friendly access to relevant information while denying adversaries and enemies the opportunity to affect friendly information and information systems. Defensive IO limit the vulnerability of C2 systems.

Information Operations Elements

11-56. Integrating offensive and defensive IO is essential to success. Many activities or operations comprise IO. Each element may have offensive or defensive applications (see FM 3-13).

11-57. **Military Deception.** Military deception includes measures designed to mislead adversaries and enemies by manipulation, distortion, or falsification. Its aim is to influence the enemy's situational understanding and lead him to act in a manner that favors friendly forces.

11-58. **Counterdeception.** Counterdeception includes efforts to negate, neutralize, or diminish the effects of, or gain advantage from, a hostile deception operation. Counterdeception supports offensive IO by reducing harmful effects of enemy deception. Defensively, counterdeception identifies enemy attempts to mislead friendly forces.

11-59. **Operations Security.** Operations security (OPSEC) denies the enemy information critical to the success of friendly military operations. It contributes to the security of Army forces and their ability to surprise enemies and adversaries. OPSEC identifies routine activities that may telegraph friendly intentions, operations, capabilities, or military activities. It acts to suppress, conceal, control, or eliminate these indicators. OPSEC includes countersurveillance, signal security, and information security.

11-60. **Physical Security.** Physical security prevents unauthorized access to equipment, installations, and documents. It safeguards and protects information and information systems.

11-61. **Electronic Warfare.** Electronic warfare (EW) is military action involving the use of electromagnetic and directed energy to control the electromagnetic spectrum or to attack the enemy. EW can cause an enemy to misinterpret the information received by his electronic systems. EW includes—

- **Electronic attack.** Electronic attack involves actions taken to degrade, neutralize, or destroy enemy electronic combat capabilities. Actions may include lethal attack, such as antiradiation missiles and directed energy weapons, and nonlethal electronic attack, such as jamming.

Information Operations Elements

- Military deception
- Counterdeception
- Operations security
- Physical security
- Electronic warfare
 - Electronic attack
 - Electronic protection
 - Electronic warfare support
- Information assurance
- Physical destruction
- Psychological operations
- Counterpropaganda
- Counterintelligence
- Computer network attack
- Computer network defense

- **Electronic protection.** Electronic protection involves actions taken to protect friendly use of the electronic spectrum by minimizing the effects of friendly or enemy EW. Actions may include radio silence and antijamming measures.
- **Electronic warfare support.** Electronic warfare support involves detecting, identifying, locating, and exploiting enemy signal emitters. It contributes to achieving situational understanding, target development and acquisition, damage assessment, and force protection.

11-62. **Information Assurance.** Information assurance protects and defends information systems. Threats to information systems include physical destruction, denial of service, capture, environmental damage, and malfunctions. Information assurance provides an enhanced degree of confidence that information and information systems possess the following characteristics: availability, integrity, authentication, confidentiality, and nonrepudiation. Computer network defense is part of this element.

11-63. **Physical Destruction.** Physical destruction applies combat power against IO-related targets. Targets include information systems, EW systems, and command posts. Physical destruction that supports IO is synchronized with other aspects of the operation. For example, when deciding whether to destroy an enemy command post, the friendly commander weighs the advantages gained from disrupting enemy C2 against those gained from collecting information from the command post's radio traffic.

11-64. **Psychological Operations.** Psychological operations (PSYOP) are planned operations that influence the behavior and actions of foreign audiences by conveying selected information and indicators to them (see JP 3-53; FM 3-05.30). The aim of PSYOP is to create behaviors that support US national interests and the mission of the force. PSYOP are closely integrated with OPSEC, military deception, physical destruction, and EW to create a perception of reality that supports friendly objectives.

11-65. **Counterpropaganda.** Counterpropaganda includes activities directed at an enemy or adversary conducting PSYOP against friendly forces. Counterpropaganda can contribute to situational understanding and expose enemy attempts to influence friendly populations and military forces. Preventive actions include propaganda awareness programs that inform US and friendly forces and friendly populations about hostile propaganda.

11-66. **Counterintelligence.** Counterintelligence consists of activities that identify and counteract threats to security posed by espionage, subversion, or terrorism. It detects, neutralizes, or prevents espionage or other intelligence activities. Counterintelligence supports the commander's requirements to preserve essential security and protect the force.

11-67. **Computer Network Attack.** Computer network attack consists of operations that disrupt, deny, degrade, or destroy information resident in computers and computer networks. It may also target computers and networks themselves. Although theater or national elements normally conduct computer network attack, the effects may be evident at corps and below.

11-68. **Computer Network Defense.** Computer network defense consists of all measures to defend computers and other components that are

interconnected in electronic telecommunications networks against computer network attacks by an adversary. Such measures include access controls, detection of malicious computer code and programs, and tools to detect intrusions. Army forces use inherent capabilities and accomplish specific computer network defense actions to defend computer networks from unauthorized users.

Related Activities

11-69. Public affairs and CMO are activities related to IO. Both communicate information to critical audiences to influence their understanding and perception of military operations. Related activities are distinct from IO because they do not manipulate or distort information; their effectiveness stems from their credibility with the local populace and news media. Public affairs and CMO—prime sources of information—link the force, the local populace, and the news media. They also provide assessments of the impact of military operations on civilians, neutrals, and others within the battlespace.

11-70. **Public Affairs.** Public affairs operations influence populations by transmitting information through the news media. They fulfill the Army's obligation to keep the American people and the Army informed. Public affairs help to establish conditions that lead to confidence in the Army and its readiness to conduct operations in peace, conflict, and war. Disseminating this information is desirable and consistent with security. Information disseminated through public affairs counters the effects of propaganda and misinformation.

11-71. **Civil-Military Operations.** CMO applies civil affairs to military operations. It encompasses activities that commanders take to establish, maintain, influence, or exploit relations between military forces and civil authorities—both governmental and nongovernmental—and the civilian populace. Commanders direct these activities in friendly, neutral, or hostile AOs to facilitate military operations and consolidate operational objectives. Civil affairs may include performance by military forces of activities and functions normally the responsibility of local government. These activities may occur before, during, or after other military actions. They may also occur as stand-alone operations. CMO is the decisive and timely application of planned activities that enhance the relationship between military forces and civilian authorities and population. They promote the development of favorable emotions, attitudes, or behavior in neutral, friendly, or hostile groups. CMO range from support to combat operations to assisting countries in establishing political, economic, and social stability (see JP 3-57).

PLANNING AND PREPARING TO ACHIEVE INFORMATION SUPERIORITY

11-72. Information superiority requires extensive planning and preparation. It cannot be an afterthought. As an element of combat power, information requires the same attention as the other elements.

11-73. The foremost information superiority planning requirement is vertical and horizontal integration of ISR, IO, and IM. Army force plans support joint force commander (JFC) objectives and receive support from the JFC. In

particular, offensive IO follow a common theme and are directed against supporting objectives. If not integrated, IO at different echelons may counteract each other.

11-74. Preparation focuses on IM and deploying the right ISR assets to support the force. Because Army forces are in varying states of modernization, the integration of information systems requires not only careful planning but also rehearsal and testing, whenever time permits. IM planning ensures that Army forces are able to disseminate relevant information vertically and horizontally. Commanders assess their information requirements against collection capabilities and tailor the force accordingly.

CONTINUOUS COORDINATION

11-75. Continuous coordination distinguishes effective C2. The impact of information technologies increases the importance of coordination. There is an unfortunate tendency to accept everything that appears on a computer screen. Coordination, focused by CCIR, verifies information. Constant coordination identifies friction in IM and develops solutions. Coordination between humans becomes the lubricant that drives IM within each headquarters. Commanders emphasize the necessity of coordination between higher and lower units as well as adjacent and supporting units. Commanders coordinate with other commanders; they understand that coordination, while primarily the task of the staff, is not solely a staff responsibility.

INFORMATION SUPERIORITY AND STRATEGIC RESPONSIVENESS

11-76. Deploying forces may not have information superiority at deployment. The commander's information needs, coupled with an understanding of METT-TC, influence force tailoring and the deployment sequence. ISR assets deploy to the theater ahead of or with initial-entry forces, depending on enemy. In areas where Army forces are already deployed and surveillance systems are established and collecting, available information may be adequate. However, crises often occur where forces are not forward deployed and intelligence is relatively sparse. In those cases, getting additional surveillance and reconnaissance assets immediately into theater becomes critical. Commanders deploy ISR and information systems with habitually supported forces. Assets assigned to early deploying units reinforce assets already deployed to or covering the theater.

11-77. The available intelligence on potential AOs may have limited tactical use. Commanders and staffs often find they must develop intelligence on an AO while their units are deploying there. To answer some specified and implied requirements, commanders may use subject matter experts. Subject matter experts understand the terrain, culture, enemy capabilities, and civil considerations of the AO and can help staffs develop estimates. Contingency operations in response to unanticipated crises are usually conducted under time constraints. It is critical that commanders and staffs consult subject matter experts familiar with the AO while developing the commander's vision, establishing CCIR, and refining situational understanding.

11-78. As intelligence is refined and IPB continues, commanders focus surveillance and reconnaissance assets to collect additional information or verify

existing intelligence. Persistent gaps may require additional collection assets. In a low-threat environment, host nation assets may provide significant augmentation and reduce requirements for US assets. In a high-threat environment, extensive reconnaissance and surveillance may be required before the main body deploys. All these factors influence how commanders tailor their forces (see Figure 11-4).

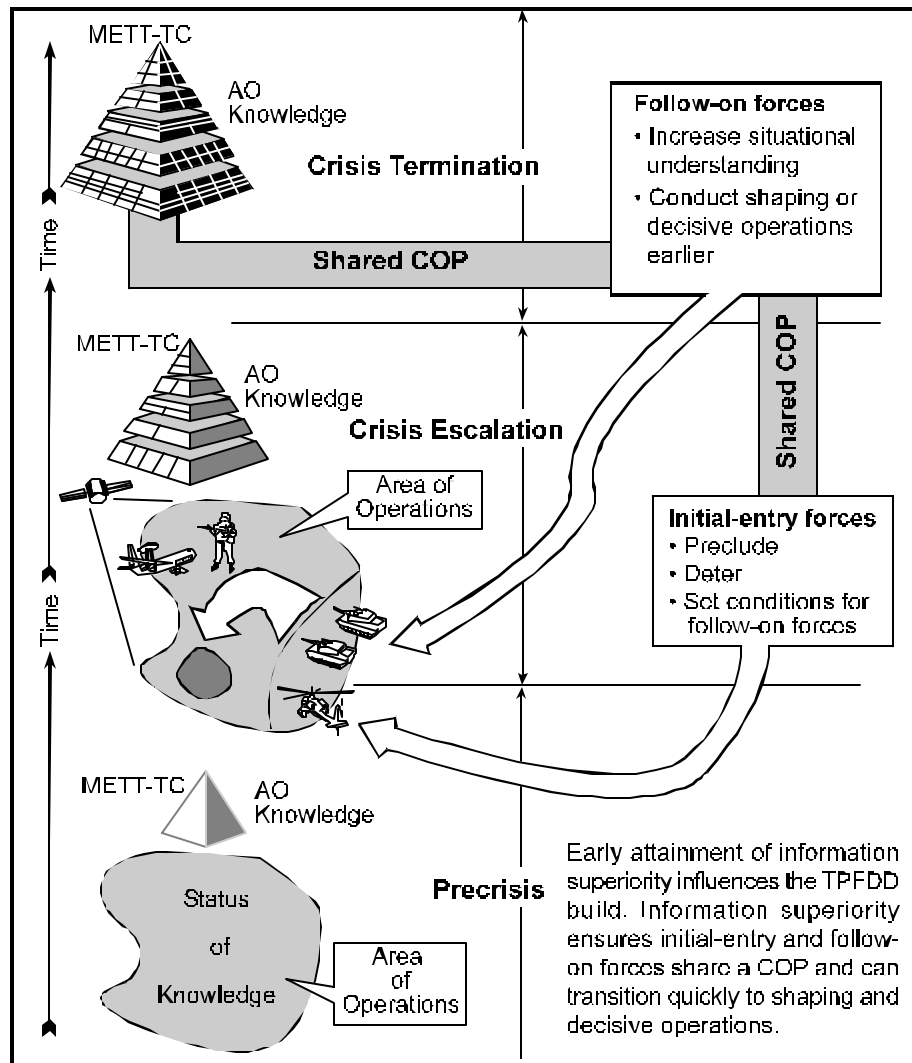

Figure 11-4. Information Superiority and Strategic Responsiveness

INFORMATION SUPERIORITY EXECUTION

11-79. Information superiority enables decisive action and is, in turn, complemented by that action. IO achieve greatest effect when complementing other operations. Effective jamming, for example, is a nuisance to an enemy force postured for defense but not facing assault. Confronted with swiftly maneuvering Army forces, however, effective jamming that degrades enemy C2 and synchronization can significantly disrupt enemy operations.

OPERATIONS IN NONCONTIGUOUS AREAS OF OPERATIONS

11-80. Noncontiguous areas of operations challenge commanders to use intelligence elements, reconnaissance units, and surveillance systems efficiently and imaginatively. When operating in noncontiguous AOs, commanders focus collection operations on areas between formations. Surveillance and reconnaissance assets cover areas between noncontiguous AOs. When the area requiring coverage exceeds the capabilities of reconnaissance units, commanders coordinate for additional coverage, with joint elements if available. When necessary, commanders task other forces to complement surveillance and reconnaissance assets.

SUBORDINATE INITIATIVE

11-81. Commanders depend on subordinate initiative to accomplish missions, even in the absence of orders or a COP. Information technology enhances Army operations but does not govern them. Inevitably, some information systems will fail—either of their own accord or because of enemy action. Commanders develop and communicate their vision to subordinates with enough clarity to allow them to act when this happens. Subordinates complement initiative with constant coordination and by keeping their higher commanders informed. Because Army forces must be able to execute in the absence of a COP, senior commanders avoid the temptation to overcontrol subordinates.

11-82. The capabilities of new information systems encourage subordinates to exercise disciplined initiative. A COP gives subordinates access to the same information as their commanders and tailors it to subordinate needs. Subordinates who know their commander's intent can act based on the COP, confident that their commander will understand what they are doing and why. More complete information allows well-trained leaders to make better decisions. A force in which commanders make good decisions at the lowest level will operate faster than one where decisions are centralized. Such a force is agile and can exploit opportunities as soon as they occur. As subordinates report their actions, those reports become part of the COP. Elements of the force affected by the action learn of it and can synchronize their actions with it. Properly used, modern information systems allow commanders to issue mission orders and control the battle through empowered subordinates. These subordinates can make decisions that fit both their immediate circumstances and the mission of the force as a whole.

THE IMPACT OF TECHNOLOGY

11-83. The increased range and lethality of weapons systems, faster tempo, shorter decision cycles, and extended battlespace all serve to increase confusion and the volume of information. The key to achieving situational understanding and avoiding information overload is identifying relevant information and filtering out distractions. Although emerging user-friendly technologies will facilitate coordinating, fusing, sharing, and displaying relevant information, these functions remain very human. The extended battlespace places increased emphasis on the initiative, judgment, and tactical and technical competence of skilled subordinate leaders. Current information technology is no substitute for small unit training and aggressive leadership.

11-84. Information technology helps commanders lead by allowing them more freedom to move around the battlefield while remaining connected electronically to the command post. This capability allows commanders to add their personal observations and feel for the ongoing operation to the synthesized information in the COP. Commanders can increase face-to-face contact with subordinates at decisive points without losing sight of the overall situation.

11-85. Technology is creating new techniques for displaying and disseminating information. Imagery, video, color graphics, digital maps and overlays all present relevant information faster and more precisely than analog methods. These new capabilities allow greater understanding by different audiences. Today, for example, commanders use collaborative planning across data networks to link subordinates with commanders throughout the operations process. Displays of information tailored to suit the audience, reduce acronyms, and eliminate jargon are particularly important when dealing with joint, multinational, and interagency participants. Technology allows staffs to quickly produce such tailored displays.

11-86. Modern technology provides a variety of means for commanders to see and engage the enemy in depth. Sensor-to-shooter links used with precision weapons enable forces to strike multiple targets simultaneously in near real-time with little regard for distance or geography. What these systems hit and when they hit it are important decisions. The results are in the effects they create, not solely in the targets they destroy. Systematic lethal attacks on enemy C2 systems provide leverage for air and ground forces and help create the conditions for success. By their nature, these effects are temporary; commanders must exploit them with maneuver to make them permanent.

11-87. Information technology can reduce, but not eliminate, uncertainty. It gives commanders windows of opportunity that, with quick and decisive action, help them seize the initiative. Commanders may lose opportunities if the quest for certainty leads them to centralize control and decision making. Technologically assisted situational understanding may tempt senior leaders to micromanage subordinate actions. This is not new; the telegraph and the command helicopter created similar tensions. Senior commanders need to develop command styles that exploit information technology while allowing subordinates authority to accomplish their missions. Exploiting the capabilities of information technology demands well-trained leaders willing to take risks within the bounds of the commander's intent. An understanding of the capabilities and limitations of information technology mitigates those risks.

Chapter 12

Combat Service Support

Before a commander can even start thinking of maneuvering or giving battle, of marching this way and that, of penetrating, enveloping, encircling, of annihilating or wearing down, in short of putting into practice the whole rigmarole of strategy, he has—or ought—to make sure of his ability to supply his soldiers with those 3,000 calories a day without which they will very soon cease to be of any use as soldiers; that roads to carry them to the right place at the right time are available, and that movement along these roads will not be impeded by either a shortage or a superabundance of transport.

Martin Van Creveld
Supplying War

12-1. Combat service support (CSS), like all other battlefield operating systems, is commanders' business. Commanders view operations and CSS as interdependent. CSS is an enabling operation that generates and sustains combat power for employment in shaping and decisive operations at the time and place the force commander requires. Commanders lay the groundwork to seize the initiative, maintain momentum, and exploit success by combining and balancing mission and CSS requirements.

CONTENTS

Purpose of Combat Service Support	12-2
CSS Characteristics	12-3
CSS Functions	12-4
CSS Planning and Preparation	12-5
CSS Planning	12-6
CSS Preparation	12-7
CSS Execution	12-11
CSS in Offensive Operations	12-11
CSS in Defensive Operations	12-12
CSS in Stability Operations	12-13
CSS in Support Operations	12-13
Tactical Combat Service Support	12-14
Army CSS Within Joint Operations	12-14
National Providers and National Strategic Support	12-15
Extending Operational Reach and Sustainability	12-16
The Impact of Technology	12-19

12-2. The force commander is responsible for integrating CSS into the overall operation. The CSS commander, as the force commander's primary CSS operator, assists in this. Operators and CSS planners view complex military problems from different perspectives. Without integration, the overall operation and CSS proceed along separate paths that may not support each other. With integration, the operational and CSS perspectives both contribute to the common operational picture (COP) that supports continuous assessment, planning, preparation, and execution.

PURPOSE OF COMBAT SERVICE SUPPORT

12-3. CSS is a major component of sustaining operations. The art of CSS involves projecting a strategically responsive force that generates decisive combat power. Successful application of the art of CSS requires proper synchronization between operational and tactical commanders and their CSS commands. Effective synchronization of operational and tactical requirements enables force commanders to initiate and sustain operations and extend their operational reach.

12-4. **Combat service support reach operations involve the operational positioning and efficient use of all available CSS assets and capabilities, from the industrial base to the soldier in the field** (see Figure 12-1). They enable force commanders to extend operational reach and to deploy and employ the force simultaneously, without pause. CSS reach operations merge operational art and science into an operations enabler. They minimize the CSS footprint in theater by deploying the minimum essential CSS elements to the area of operations (AO) and establishing links to and fully exploiting all available sources of support. CSS reach operations include the use of intermediate staging bases (ISBs), forward-deployed bases, Army pre-positioned stocks, and continental US (CONUS) resources. CSS reach operations capitalize on split-based and modular operations; they take maximum advantage of all available sources of support for follow-on sustainment.

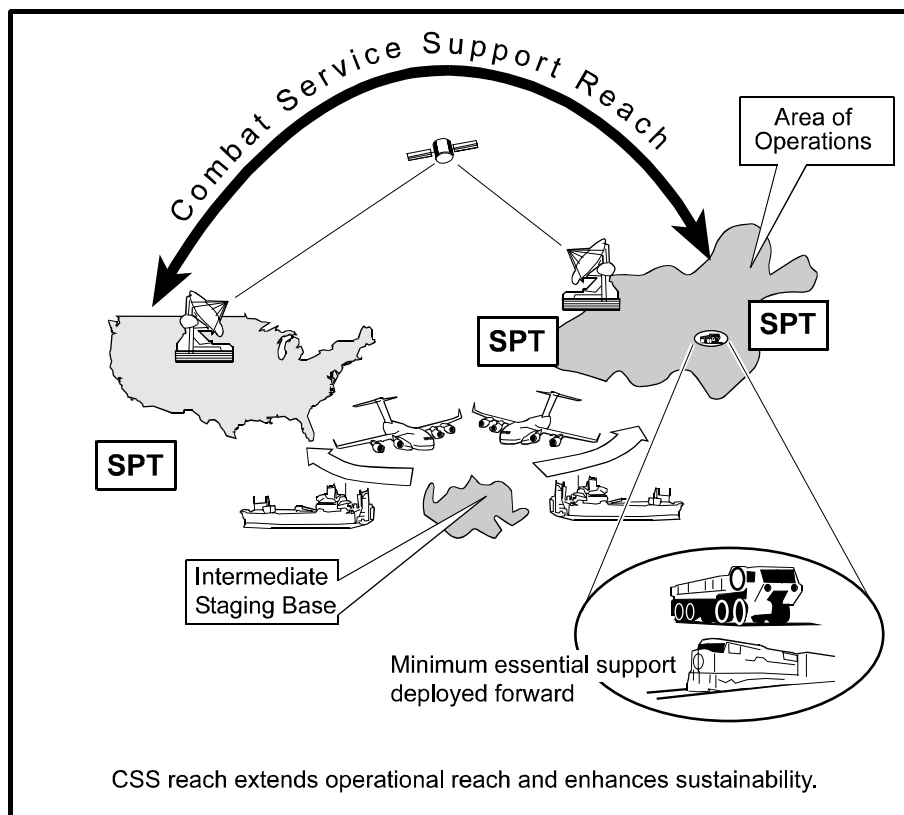

Figure 12-1. Combat Service Support Reach

12-5. CSS is integrated at all levels of war through a seamless distribution system. Active and reserve component, DOD and DA civilian, contractor, joint, and multinational assets all provide CSS from CONUS to and within the theater of operations. CSS operations enable the commander to generate combat power for employment in conducting shaping and decisive operations within the required time and at a tempo faster than the enemy can react.

COMBAT SERVICE SUPPORT CHARACTERISTICS

12-6. Force commanders visualize and describe the concept of CSS together with their CSS commanders. To help them describe the considerations required to conduct (plan, prepare, execute, and assess) successful operations, commanders view CSS characteristics from the perspective of the overall operation. CSS characteristics are integrated throughout the operational framework, guide prudent planning, and assist the staff in developing the support plan. (FM 4-0 discusses the relationship between joint logistic and joint personnel principles and the US Army CSS characteristics). CSS characteristics seldom exert equal influence, and their importance varies by situation. The commander identifies CSS characteristics having priority during an operation; they become the foundation for preparing the concept of CSS. The CSS characteristics are—

- **Responsiveness.** Responsiveness is the crucial characteristic of CSS. It means providing the right support in the right place at the right time. Responsiveness includes the ability to foresee operational requirements. It involves identifying, accumulating, and maintaining the minimum assets, capabilities, and information necessary to meet support requirements. On the other hand, the force that accumulates enough material and personnel reserves to address every possible contingency usually cedes the initiative to the enemy.
- **Simplicity.** Simplicity means avoiding complexity in both planning and executing CSS operations. Mission orders, drills, rehearsals, and standing operating procedures (SOPs) contribute to simplicity.
- **Flexibility.** The key to flexibility lies in the expertise for adapting CSS structures and procedures to changing situations, missions, and concepts of operations. CSS plans and operations must be flexible enough to achieve both responsiveness and economy. Flexibility may include improvisation. Improvisation is the ability to make, invent, or arrange for what is needed from what is at hand. Improvised methods and support sources can maintain CSS continuity when the preferred method is undefined or not usable to complete the mission.
- **Attainability.** Attainability is generating the minimum essential supplies and services necessary to begin operations. Commanders determine minimum acceptable support levels for initiating operations.
- **Sustainability.** Sustainability is the ability to maintain continuous support during all phases of campaigns and major operations. CSS planners determine CSS requirements over time and synchronize the delivery of minimum sustainment stocks throughout the operation.
- **Survivability.** Being able to protect support functions from destruction or degradation equates to survivability. Robust and redundant support contributes to survivability, but may run counter to economy.

- **Economy.** Resources are always limited. Economy means providing the most efficient support to accomplish the mission. Commanders consider economy in prioritizing and allocating resources. Economy reflects the reality of resource shortfalls, while recognizing the inevitable friction and uncertainty of military operations.
- **Integration.** Integration consists of synchronizing CSS operations with all aspects of Army, joint, interagency, and multinational operations. The concept of operations achieves this through a thorough understanding of the commanders' intent and synchronization of the CSS plan. Integration includes coordination with and mutual support among Army, joint, multinational, and interagency CSS organizations.

CSS characteristics are integrated throughout the operational framework. They guide prudent planning and assist the staff in developing the CSS plan (see JP 1-0; JP 4-0; FM 4-0).

COMBAT SERVICE SUPPORT FUNCTIONS

12-7. CSS consists of many interrelated functions. Planning, managing, and executing support involves synchronizing and integrating them. At all levels of operations, the key CSS functions include—

- **Maintenance.** Keep materiel in a serviceable, operational condition, return it to service, or update and upgrade its capability (see FM 3-04.500; FM 4-30.2).
- **Transportation.** Move and transfer units, personnel, equipment, and supplies to support the concept of operations (see JP 4-01; FM 4-01).
- **Supply.** Acquire, manage, receive, store, and issue all classes of supply (except Class VIII) required to equip and sustain Army forces. Supply also covers the turn-in, exchange, and/or disposition of items (see JP 4-0; JP 4-03; FM 4-20).
- **Combat health support.** Maintain the force by preventing disease nonbattle injury (DNBI) casualties; clearing the battlefield of casualties; providing forward medical treatment; providing en route care during medical evacuation; ensuring adequate Class VIII supplies and medical equipment are available; and providing veterinary, dental, and laboratory services (see JP 4-02; FM 4-02).
- **Field services.** Feed, clothe, and provide personal services for soldiers. Field services include clothing exchange, laundry, shower, textile repair, mortuary affairs, aerial delivery, and food services (see JP 4-06; FM 4-20).
- **Explosive ordnance disposal.** Neutralize domestic or foreign conventional, nuclear, chemical, and biological munitions and devices that present a threat to military operations and civilian facilities, materiel, and personnel (see FM 3-100.38; FM 4-30.12).
- **Human resources support.** Provide all the activities and systems needed for manning the force, personnel support, and personnel services to service members, their families, DA civilians, and contractors. These activities include personnel accounting; casualty management; essential services; postal operations; and morale, welfare, and recreation (see JP 1-0; FM 1-0).

- **Financial management operations.** Financial management operations provide finance and resource management services to commanders. Finance services include pay for vendors, services, accounting, central funding, technical advice, and policy guidance. Resource management services include technical advice to commanders on resource management implications and on the costs of preparing and conducting operations (see JP 1-06; FM 1-06).
- **Religious support.** Provide and perform religious support operations for the commander to protect the soldiers', family members', and authorized civilians' free exercise of religion. This includes the personal delivery of rites, sacraments, ordinances, spiritual care, religious counseling, spiritual fitness training and assessment, religious worship services, and advice to the command on matters of religion, morals, morale, and coordination with nongovernmental organizations (NGOs) and private voluntary organizations as appropriate (see JP 1-05; FM 1-05).
- **Legal support.** Perform operational law duties and provide advice and services in military justice, international law, administrative law, civil law, claims, and legal assistance in support of the command, control, and sustainment of operations (see FM 1-04).
- **Band Support.** Provide music to enhance unit cohesion, morale, and to musically support the entire spectrum of military operations. Support information operations, and should be integrated into public affairs, civil affairs, and psychological operations plans. When the musical mission of bands is no longer feasible due to the intensity of conflict, augment security operations for command posts, or augment perimeter security for enemy prisoner of war and civilian internee operations (see FM 1-08).

12-8. General engineering and contract support also support sustaining operations. General engineering involves constructing, repairing, operating, and maintaining infrastructure and facilities to enhance provision of sustainment and services (see JP 4-04; FM 3-34.250). Contracting support obtains and provides supplies, services, and construction labor and materiel. Contracting often provides a responsive option or enhancement to support the force (see FM 4-100.2).

COMBAT SERVICE SUPPORT PLANNING AND PREPARATION

12-9. Commanders of combatant commands, joint forces, ARFORs, Army service component commands (ASCCs), theater support commands, and other operational-level organizations are primarily responsible for CSS planning and preparation within a theater. CSS commanders assist force commanders in developing CSS plans based on the vision and intent of higher commanders. Force commanders visualize what needs to be done to support their concept of operations and convey that vision and intent to their CSS commanders. CSS commanders and staffs develop the concept of CSS. The staff then directs subordinate units to take actions to support the concept of operations. They consider availability of sustainment support from the CONUS base, support from pre-positioned stocks, the maturity of CSS resources in theater,

host nation and multinational support available, and support provided by other organizations. This process is common to all levels of command.

COMBAT SERVICE SUPPORT PLANNING

12-10. Force commanders integrate operational and CSS planning through the COP. They require timely CSS information to plan effectively. Staffs assist commanders by determining detailed CSS requirements during mission analysis. CSS planners use planning factors to quantify requirements. Parallel planning among staffs develops CSS plans that provide enough support to generate the requisite combat power for each phase of the operation. The CSS plan anticipates CSS requirements by phase; CSS operators respond to adjustments force commanders make during execution. CSS planning lets commanders make operational adjustments while the force continually generates and sustains combat power.

Combat Service Support Priorities

12-11. Force commanders maximize the use of limited resources by establishing CSS priorities and directing priorities of support. CSS commanders and staffs then develop a concept of CSS that meets the force commander's intent and planning guidance. In developing the concept of CSS, they ensure that it is responsive and flexible enough to accommodate changes in the situation. The force commander's decision to exploit an opportunity, reconstitute, prepare for future operations, or continue current operations may alter CSS priorities. Shifting operational priorities may require a corresponding shift in CSS priorities. During shifts, a temporary reduction in CSS capability may occur; however, CSS operations never completely cease.

Combat Service Support Estimates

12-12. The force commander directs the staff and CSS commanders to provide estimates that examine support to operational missions and requirements. CSS estimates, based on a thorough logistics preparation of the theater, provide a comprehensive and meaningful picture of CSS units, their capabilities, and options for employment. Personnel, combat health support, and CSS estimates are used to develop CSS plans and annexes. Force commanders require CSS personnel to express capabilities and their implications in operationally significant terms. Force commanders state their requirements to CSS commanders and staffs in a manner that achieves shared understanding. These requirements may include—

- The distance and locations to move the force.
- How positioning CSS assets affects the concept of operations.
- How long particular equipment must remain operational under tactical conditions.
- The types of material necessary for shaping and decisive operations throughout the AO.
- The availability and authority for use of Army pre-positioned stocks.
- Awareness of factors that limit operational reach and sustainability and ways to alleviate the situation.
- Rapid recovery and redeployment of scarce logistic assets, equipment, and supplies following the completion of operations.

- Expected medical or DNBI casualties and replacement rates.
- Security considerations based on the current threat assessment.
- Resource constraints on operational infrastructure repair.

12-13. Commanders understand that CSS is both an art and a science. The CSS command and staff challenge is to present force commanders with meaningful information that uses operational measures of support at the appropriate level of detail. Technology advances—such as improved asset visibility, the global transportation network, improved distribution methods, and enhanced CSS reach capabilities—enable CSS planners to prepare credible CSS plans that meet force commander requirements.

Concept of Combat Service Support

12-14. Force commanders use CSS characteristics to describe how CSS capabilities enable the force to generate and sustain combat power. CSS commanders and staffs use the military decision making process to develop CSS courses of action. The concept of CSS derives from the course of action that best supports the overall operation. In evaluating courses of action, commanders and staffs ask questions similar to these:

- Does the force projection flow generate the requisite combat power in accordance with the operational commander's priorities?
- Are we generating the appropriate level of CSS at the right locations for each phase of the operation?
- Can we simultaneously sustain the entire force throughout the operation?
- Which characteristics of CSS have priority during each phase of the operation? Are they addressed in the CSS plan?
- Are the distribution networks in place to accommodate the sustainment flow?
- Can we generate the operational reach and sustainability adequate for simultaneous and continuous operations, or do we accept an operational pause?
- Have we achieved the proper balance between combat, combat support (CS), and CSS forces, thereby optimizing our operational reach and sustainability?
- What is the plan for reconstitution of forces, if required?
- Have we adjusted the CSS factors influencing operational reach and sustainability, thereby maximizing the effectiveness of the distribution system and the lines of communications (LOCs)?
- Have we taken advantage of all available facilities, resources, and sources of support?
- Have we allocated resources and established CSS priorities?
- Have we assigned responsibilities and made the necessary command and control (C2) arrangements to execute the support plan?

COMBAT SERVICE SUPPORT PREPARATION

12-15. The force commander prepares the battlespace by integrating the operational and CSS components. CSS commanders assist by obtaining,

managing, and distributing the resources identified during planning. Negotiating host nation support agreements, contingency contracts, and other bilateral agreements, such as the acquisition and cross-service agreements (ACSAs), are part of this effort. CSS preparation also includes coordinating with strategic-level CSS managers to gain access to pre-positioned stocks or assets received through national-level agreements. Support base locations and LOCs are established and improved to meet operational requirements. Theater infrastructure, host nation support, multinational CSS, and contracted support are vital to Army CSS plans and operations. Each contributes to generating and sustaining combat power.

Theater Infrastructure

12-16. Army forces deploy with sufficient CSS to conduct operations upon arrival in theater. That amount may vary, depending on the availability of pre-positioned stocks. For protracted operations, CSS personnel plan for and prepare the essential theater infrastructure to establish the support base. The support base becomes critical for long-duration, enhanced responsiveness and force sustainability. All required facilities are usually not available at the start of operations. Facility capacities may be inadequate or damaged. Improving the theater base capabilities may require early deployment of maintenance, engineering, or terminal operations forces. Contracting support staff and medical, finance, legal, civil affairs, and resource management personnel—who are among the first to deploy—arrange access to host nation capabilities at staging and support bases. The requirement for adequate CSS capability is especially important in the early stages of operations, when reception, staging, onward movement, and integration are critical.

12-17. The time required to prepare a support base depends upon the extent and nature of the existing civil and military infrastructure in theater. When ports, airfields, roads, depots, repair facilities, supplies, and transportation facilities exist, CSS operations begin quickly, without establishing a new support base. When capabilities do not exist, Army units operate from austere theater bases until CSS facilities are built. In an immature theater, CSS and construction units are needed much earlier in the deployment flow.

12-18. Army watercraft are often essential in an immature theater. They allow commanders to avoid obstacles and enhance their scheme of maneuver. Army watercraft can self deploy to the theater of operations, augment existing seaport capabilities with in-stream offloading, and support reception capabilities through joint logistics over-the-shore (JLOTS) operations. They can supplement limited surface transportation capabilities by allowing coastal waterways to be used as main supply routes or through riverine operations.

Host Nation Support

12-19. Host nation support agreements are formal agreements with a nation to provide support and services. They include in-theater as well as en route support. Host nation support agreements can significantly reduce the preparation requirement for early augmentation of CSS forces. Their effective use can reduce the CSS forces required in theater and free early strategic lift for other purposes. Host nation support may include resources, transportation

assets, civilian labor, local security and police forces. Other examples include—

- Operation, maintenance, and security of seaports and airports.
- Construction and management of routes, railways, and inland waterways.
- Transportation support.
- Provision of limited health services.
- Subsistence support.
- Laundry and bath support.
- Petroleum support and bulk storage or warehouse support for storage.
- Augmentation of existing communication and automation networks.
- Indigenous religious leadership support.

Multinational Support

12-20. US law requires US forces to be reimbursed for support they provide to other militaries. When the necessary agreements are in place, Army forces may provide CSS to and receive support from multinational forces. Operations in Saudi Arabia, Somalia, Bosnia, and Kosovo all required support to multinational partners. Given authority, the US negotiates agreements with multinational partners. Even in cases where formal agreements exist, multinational sustainment presents a challenge. Commanders assess differences in support doctrine, quality of support standards, stockage levels, CSS mobility, interoperability, infrastructure, national resource limitations, and domestic law for their effect on preparation. The level of standardization among participating countries affects how support is provided.

12-21. In the absence of appropriate international agreements, no authority exists for combatant commanders to provide for or accept CSS from multinational partners. Legal authority to exchange support with multinational partners rests with host nation support agreements and other bilateral agreements, such as ACSAs. Approval to exchange support with NGOs normally comes

A coordinating authority is ... [an] individual assigned responsibility for coordinating specific functions or activities involving forces of two or more military departments or two or more forces of the same service.... Coordinating authority is a consultation relationship, not an authority through which command may be exercised.

from the Department of State. Bilateral agreements are necessary to leverage local resources to support deployed forces. Commanders and staffs at all levels need to be familiar with the scope and authorities provided by existing agreements. Staff estimates should reflect only those resources provided for by agreement. Negotiation and approval of these agreements may be restricted to the National Command Authorities or may be limited by statute or other legislative restrictions. Where no international agreements exist, requirements that need negotiation and approval must be identified early. The operational law judge advocate can assist in resolving issues involving international agreements.

12-22. Preparing for multinational support starts early in the planning process and continues throughout an operation. Although CSS is primarily a national responsibility, that fact cannot supplant detailed multinational CSS planning. Planners provide for emergency support that goes beyond requirements for temporary or routine circumstances. In some cases, US commanders exercise control over the various national support units; in others, they may have only coordinating authority. A multinational military commission may be formed to determine what nations are assigned specific support functions. When feasible, multinational commanders form a multinational support staff section (see FM 3-16).

12-23. Forces may be designated as lead nation or role specialization nation. *Lead nation* occurs when one nation assumes the responsibility for providing a broad spectrum of support in all or part of a multinational operation. *Role specialization* occurs when one nation assumes the responsibility for providing a particular class of supply (for example fuels) or service.

12-24. Multinational force commanders may exercise directive CSS authority only under formal multinational agreements. The degree of authority depends on existing agreements or arrangements negotiated among participating nations (see JP 4-08).

Contracted Support

12-25. Throughout its history, the Army has used contractors to support operations. Army forces increasingly rely on contracted support. Using contractors may help prepare CSS by decreasing strategic lift requirements and reducing reliance on military support forces (see JP 4-0; FM 3-100.21; FM 4-100.2). The following types of contractors support Army operations:

- **Systems contractors.** Systems contractors support deployed forces under prearranged contracts awarded by project managers, program evaluation offices, and the US Army Material Command (AMC). They provide specific materiel systems throughout their life cycle, during both peacetime and contingency operations. These systems include, but are not limited to, vehicles, weapons systems, aircraft, C2 infrastructure, and communications equipment.
- **External support contractors.** External support contractors work under contracts awarded by contracting officers serving under the command and procurement authority of supporting headquarters outside the theater. They augment the supported commander's organic CSS capability. For example, AMC's logistics civil augmentation program (LOGCAP) provides external support contractors through its prearranged umbrella contract. AMC logistic support elements administer these contracts in theater.
- **Theater support contractors.** Theater support contractors support deployed operational forces under prearranged contracts or contracts awarded from the mission area. Theater support contractors provide goods, services, and minor construction—usually from local vendors—to meet the immediate operational needs (see FM 4-100.2).

Contractor Support—Operations in the Balkans

As part of Operation Joint Endeavor in 1995, Army forces deployed 25,000 troops into Bosnia under uncertain conditions during the worst Balkan winter in 100 years. Army force commanders understood that war-torn Bosnia was an immature theater requiring extensive LOGCAP support. The deployment plan also called for establishing an ISB at Kaposvar and Taszar in Hungary, where units prepared for operations before entering the theater. Logisticians from the 21st Theater Army Area Command identified the requirements, and the deputy chief of staff for logistics, US Army, Europe, contracted for billeting, food, laundry and bath services, sanitation, transportation, base camp construction, and translators in the ISB before deployment. Contractors provided similar services in Bosnia, where numerous base camps supported the force. Contracted trucks hauled tons of building material, gravel, and other construction supplies as well as food, water, and other necessities. As in past operations, commanders retained total responsibility for soldier needs. However, contractors executed steady-state sustainment that enhanced the Army support structure and contributed toward mission accomplishment.

COMBAT SERVICE SUPPORT EXECUTION

12-26. The force commander is responsible for integrating CSS considerations into the overall operation. The types and quantities of CSS required and the methods used to provide it vary by type of operation.

COMBAT SERVICE SUPPORT IN OFFENSIVE OPERATIONS

12-27. Force commanders consider how the operational framework and CSS affect each other during offensive operations. A commander's decision to fight a simultaneous or sequential, linear or nonlinear operation may depend on CSS capabilities. CSS operations may be affected dramatically by such decisions. For example, in linear offensive operations, commanders may secure CSS assets on ground LOCs with maneuver forces. In nonlinear operations, commanders may move CSS primarily by air. Regardless of the operational framework, CSS commanders and staff support the decisive offensive operation at the time and place of the force commander's choosing.

12-28. Effective CSS in offensive operations demands CSS operators who foresee requirements and prepare to meet them before they occur. Force commanders require a simple concept of CSS that is responsive and flexible enough to adjust while executing offensive operations. To sustain momentum and provide freedom of action to exploit success, they integrate CSS considerations into plans. To ensure continuity of support, plans include provisions for CSS units to follow exploiting forces. Due to the tempo of offensive operations, units may experience high losses from combat operations, combat stress, and fatigue. Recognizing the potential for loss during offensive operations, commanders plan for reconstitution. Planners consider the potential effects these losses have on tactical operations, combat health support operations, strength and casualty reporting, replacement operations, religious support, and soldier morale.

12-29. Commanders visualize the effects of rapid tempo on their ability to sustain offensive operations. The tempo and depth of offensive operations wear out equipment and consume great quantities of supplies, particularly bulk fuel and ammunition. The high workloads and evacuation requirements of offensive operations put stress on maintenance, Class IX, and supply operations, and increase Class VII requirements. Greater movement requirements and potentially longer LOCs tax transportation resources. As the Army transitions to a “replace forward, fix rear” maintenance system, contracted support in forward areas during offensive and defensive operations is less viable than in stability operations or support operations.

Full Spectrum Support— 22d Support Command in Southwest Asia

During Operations Desert Shield and Desert Storm, 22d Support Command CSS soldiers provided operational-level support for reception, staging, and onward movement of US and coalition forces. They employed US units and host nation assets, working with the strategic sustainment base, joint and multinational headquarters, and the host government. Army logisticians turned Dhahran airport into the primary aerial port of debarkation, with over 6,700 aircraft arriving between August 1990 and March 1991. CSS soldiers processed thousands of combat troops into the theater, an effort requiring contracted support for food, fuel, water, shelter, and transportation. Contracting, which included placing purchasing power in commanders’ hands, aided a rapid build-up. Finance, contracting, and host nation support played major roles in Army CSS efforts.

CSS units created and operated numerous CSS bases to sustain two Army corps in combat. Ammunition and fuel requirements totaled 14,000 tons and 4.5 million gallons daily. With Kuwait’s liberation, the 22d Support Command redeployed forces and sustained those left in theater. Simultaneously, CSS soldiers supported humanitarian relief actions for Kurdish refugee camps in Iraq and Turkey and sustained four prisoner of war camps holding 60,000 Iraqis. Throughout Operations Desert Shield and Desert Storm, 22d Support Command demonstrated Army support capability for full spectrum operations.

COMBAT SERVICE SUPPORT IN DEFENSIVE OPERATIONS

12-30. Tactical commanders consider CSS capabilities when deciding whether to conduct a mobile or area defense. For example, in an area defense, commanders may position CSS assets well forward to respond quickly and be protected by maneuver forces. In a mobile defense, commanders may move CSS assets further away from combat and CS forces to free up space for maneuver. Regardless of the type of defense, CSS commanders and staffs design a concept of CSS that allows a smooth transition to the offense.

12-31. CSS requirements for defensive operations depend on the type of defense. Forces in a mobile defense consume more fuel than those in an area defense. Typically, bulk fuel consumption may be less than in offensive operations. However, ammunition consumption is higher and will likely have the highest movement priority. Barrier and fortification material is moved

forward in preparation for all types of defense. Chemical defense equipment may also be a significant requirement. As with the offense, the force commander's operational design affects the concept of CSS. The CSS commander synchronizes the concept of CSS with the force commander's concept of operations. The CSS plan includes branches or sequels that address generating and sustaining combat power after the transition to offensive operations.

COMBAT SERVICE SUPPORT IN STABILITY OPERATIONS

12-32. CSS requirements in stability operations vary greatly, depending on the mission and circumstances. Force commanders conduct stability operations in complex, dynamic, and often asymmetric environments. For example, they may be required to establish a presence, separate combatants, restore order, or perform other operations that provide stability. Frequently, force commanders must repair enough infrastructure to maneuver and sustain the force while simultaneously stabilizing the situation. CSS commanders and staffs devise concepts of CSS that give force commanders flexibility to meet changing situations.

12-33. Some stability operations, such as peace enforcement operations, may involve levels of support comparable to offensive and defensive operations. In other operations, demands may be lower but distances between units may increase. In stability operations, contracted support is often more appropriate than in other operations. Contracting may be appropriate for such CSS activities as food service; morale, welfare, and recreation; billeting; transportation; shower; laundry; and clothing repair. It is important to integrate support not only with other US services and multinational partners but also with nongovernmental organizations. Class IV and explosive ordnance disposal support may be prominent requirements in stability operations.

COMBAT SERVICE SUPPORT IN SUPPORT OPERATIONS

12-34. In support operations, CSS forces may conduct the decisive operation. Support operations involve providing relatively high levels of CSS-related support to civilian populations. For example, a commander given a disaster relief mission—such as aiding victims of a hurricane where thousands of homes were destroyed—may need to provide water, food, medical care, and electricity to people in communities spread over hundreds of miles. In other support operations, such humanitarian relief missions in areas stricken by floods or drought, the force must counter disease and starvation. Support operations such as these involve providing services to meet the immediate needs of designated groups for a limited time until civil authorities can assume responsibility. Distribution of food, water, supplies, and field services are often the primary activities. Combat health support, which involves such activities as providing basic necessities and establishing or improving basic health and sanitation services, may be prominent as well. The lack of usable road space may place a greater dependency upon air assets. The Army forces best suited to accomplishing these complex missions in difficult conditions are CSS organizations.

12-35. How force commanders approach providing support to civil authorities affects the concept of CSS. CSS commanders and staffs devise concepts of CSS that meet mission requirements in the priority that force commanders specify. Planners work with multinational, joint, and interagency planners,

along with local authorities, to ensure support responsibilities, priorities, and standards, as well as rules of engagement, are clearly laid out.

TACTICAL COMBAT SERVICE SUPPORT

12-36. Tactical CSS supports battles and engagements. While tactical operations can last for weeks, tactical support is measured in days or hours. Tactical CSS sustains force momentum. It focuses resources to support the commander's intent and concept of operations and maximize freedom of action. The tactical CSS plan addresses how each CSS function supports the operation. Planning identifies CSS risks. Army units make up the bulk of the tactical CSS structure. Support also comes from host nation, joint, and multinational military organizations; DOD and DA civilians; and civilian contractors—especially in stability operations and support operations.

ARMY COMBAT SERVICE SUPPORT WITHIN JOINT OPERATIONS

12-37. Combatant commanders and staffs, along with their service component commands, manage theater strategic- and operational-level support. At the theater strategic level, combatant commanders and their subordinate service or functional component commanders generate and move forces, materiel, and sustainment into theater (see JP 3-35; JP 4-0; FM 3-35 series; FM 3-100.7).

12-38. In joint operations, coordination and execution of CSS is a service responsibility unless the combatant commander directs otherwise through lead service designation or existing interservice support agreements (ISSAs). Regardless of the joint or multinational command arrangements, the ASCC retains the responsibility for Title 10 support of all subordinate Army units through the service chain of command via administrative control (ADCON) authority. ASCC commanders, together with combatant commanders, identify CSS requirements, coordinate resource distribution from the strategic base, allocate necessary CSS capabilities, and establish Army CSS C2 relationships within the theater of operations. The ASCC commander ensures proper execution of all combatant commander- or ISSA-directed common support requirements within the theater of operations.

12-39. Operational CSS links the national sustainment base capabilities to tactical support requirements during campaigns and major operations. Planners integrate CSS and operational concerns at the operational level. Commanders rely on experience and judgment to balance the deployment and support of combat, CS, and CSS units to generate combat power in accordance with joint force commander (JFC) priorities. Staffs link tactical requirements with inbound strategic support while meeting joint and multinational support responsibilities outlined in applicable combatant command and JFC operation plans or orders.

12-40. Operational-level CSS organizations and staffs interface with elements of the strategic sustainment base that deploy into the theater of operations. National sustainment base operational and tactical-level contingency support includes—

- Defense Logistics Agency (DLA) contingency support teams.
- AMC logistic support elements.
- Elements of the US Army Medical Research and Materiel Command.

- US Transportation Command, through its component commands—the Air Mobility Command, Military Traffic Management Command, and Military Sealift Command.

12-41. Each service is responsible for supporting its own forces except when otherwise directed by DOD or combatant command directives, plans, and orders, or when provided for by agreements with national agencies, services, or other nations. While the Army has been designated as the peacetime DOD executive agent for numerous CSS-related requirements, these responsibilities are normally focused at the national strategic level and may not directly apply to a specific joint operation. In all joint operations, the combatant, joint force, and ARFOR commanders take these DOD-level responsibilities into account when determining the lead service for a specific common user logistic (CUL) requirement.

12-42. Combatant commanders use their directive authority for logistics to assign lead service CUL support requirements. Normally, the service component (or DOD agency, such as DLA) that is the dominant user or most capable organization for a particular common logistic item or service becomes the lead service. These lead service directives often require the Army to plan and provide significant CUL support to other service components, multinational partners, governmental agencies, and nongovernmental agencies. These requirements can generate major planning and resource requirements for ASCCs and the operational-level support commands tasked to meet them.

12-43. Army operational-level CSS and CUL tasks are best executed by operational-level CSS organizations designed and resourced to execute them. Operational-level support organizations include the multifunctional theater support command as well as functional engineer, finance, medical, personnel, and transportation commands. Operational-level support units deploy tailorable early-entry functional modules during the early stages of force projection. The ARFOR commander uses these tailored organizations to provide the functional expertise and C2 capabilities necessary to properly support the force. These modular organizations expand as necessary to provide the proper level of support for each operation or phase (see FM 4-93.4).

12-44. In some situations, tactical-level CSS organizations may perform operational-level support missions. In most cases, tactical-level CSS units require augmentation from echelons above division forces to properly accomplish operational-level support tasks.

NATIONAL PROVIDERS AND NATIONAL STRATEGIC SUPPORT

12-45. National-level CSS is strategic-level support provided by the national economic base, which includes the DOD and military department national providers. At the national strategic level, the Joint Staff, military departments, US Transportation Command, and national CSS providers focus on force readiness and support of force projection operations. Key national CSS providers that support Army operations include the DLA, AMC, US Army Medical Command, US Army Personnel Command, and Defense Finance and Accounting Service. Department of the Army accomplishes the force readiness mission through day-to-day execution of its Title 10 responsibilities. Army CSS Title 10 responsibilities include supplying, equipping,

administering, and maintaining the force. Meeting all responsibilities is essential to maintaining appropriate force readiness levels.

EXTENDING OPERATIONAL REACH AND SUSTAINABILITY

12-46. Operational reach and CSS reach operations are related components of the operational art. Commanders practice operational reach and CSS operations to extend their battlespace in time and space across the range of operations. Effective CSS operations are required to extend the depth and duration of full spectrum operations. Commanders study the factors that influence operational reach and sustainability. Only a thorough understanding of these factors allows commanders to understand how CSS operations generate and sustain combat power.

12-47. CSS can also extend the operational reach by reaching back to the national provider, AMC. The AMC Operations Support Command has forward elements in Korea, Southwest Asia, Europe, and CONUS. The forward elements include Army field support centers. They sustain Army materiel in theater, minimizing the load on strategic lift and theater logistics footprint. As required, the AMC forward command can deploy a modular, tailored logistic support element into the AO. AMC manages pre-positioned and afloat stocks, which are available to combatant commanders. AMC also manages the single stock fund with the ability to pull stocks as required from anywhere in the world into an integrated Army supply and maintenance program.

12-48. Effective CSS allows commanders to initiate and sustain operations over time as well as extend the operational reach of the force. Operational reach reflects the operating ranges of combat, CS, and CSS assets. Sustainability refers to the force's ability to conduct operations over time. CSS commanders enable the force commander to extend operational reach and enhance sustainability through CSS reach operations.

12-49. If military operations extend beyond a force commander's operational reach, culmination normally follows. Commanders arrange operations in time and space to avoid culmination. The essence of the art of CSS involves continuously adjusting CSS plans and operations within the commander's intent to delay or preclude an operational pause or culmination.

Combat Service Support Factors Influencing Operational Reach And Sustainability

12-50. Commanders consider secure LOCs, the distribution system, and C2 as key CSS factors that generate and sustain combat power and extend operational reach and sustainability. In allocating resources, commanders take into account the physical factors that limit a force's operational reach and freedom of action. Ignoring these factors risks culmination. To understand their influence on operations is to master the art of CSS. CSS factors influencing operational reach and sustainability include—

- **Scope of support.** The scope of support refers to the types and levels of support provided to the force. It varies with the type of operation, the time to prepare for an operation, the maturity of the theater, and the phase of the operation. As the theater matures, the type of support provided and the locations of support facilities may change.

- **Distribution networks.** The Army CSS system in theater operates within the joint theater distribution system (see JP 4-01.4; FM 4-01.4). The distribution system consists of several interrelated networks: communications and automation, physical, and resource. These networks provide the asset visibility necessary for efficient and effective distribution. The communications and automation network distributes and correlates CSS data across the force, while assisting all commanders with management of the information. The physical network consists of the quantity and capability of fixed structures and established facilities. It includes factories, warehouses, airfields, seaports, roads, railroads, inland waterways, pipelines, terminals, bridges, tunnels, and buildings. These facilities can be located in CONUS, at an ISB, at a forward deployed base, or in theater. The resource network consists of the people, materiel, and machines operating within and over the physical network.
- **Sources of support.** Support may come from DOD, Army, joint, multinational, host nation, and NGO sources. In addition, theater support contracts can be obtained through contracting or host nation support.
- **Availability of materiel.** Materiel is available to a force through its stocks and resupply. There are several internal constraints on stocks. They include the upload capacity of its soldiers and equipment and the storage capacity for materiel not uploaded. They also include the internal transportation assets needed to move supplies from stockpiles to their point of employment. Effective use of the multiple sources of support can increase the availability of materiel, enhance responsiveness, and improve the flexibility and sustainability of the operation.
- **Modularity.** Modularity is the ability to provide force elements that are interchangeable, expandable, and tailorable to meet changing missions and needs. Modular units combine the assets required to provide a support function or group of related functions. A module can be sent to support a deploying force without adversely affecting the ability of the parent unit to function at a reduced level. Modularity enhances the CSS commander's ability to conduct C2 operations as well as the functional CSS operations in a dispersed environment.

12-51. Force commanders provide for essential CSS functions by tailoring and task organizing a force capable of providing the appropriate level of support throughout an operation. This ensures a proper balance of combat, CS, and CSS capabilities. Provision of all services in the AO can enhance sustainability and operational reach. These services include personnel, medical, field services, maintenance, transportation, religious, financial management, legal, and explosive ordnance disposal.

12-52. LOCs are a key factor of operational reach and CSS reach operations. LOCs are all routes—land, water, and air—that connect military forces with their support base and along which supplies, personnel, equipment, and military forces move. The designation of LOCs and securing their use is commanders' business. LOCs and the assets on them must be protected. LOCs consist of complexes of networks, facilities, procedures, arrangements, and units. They link the strategic sustainment base to the operational support

base and the operational support base to tactical formations. Multiple LOCs require a substantial increase in forces to secure them.

12-53. LOC security and support are essential to CSS operations and may effect combat power allocation. The ability to secure LOCs is an important consideration in determining operational objectives. LOCs require particular attention during nonlinear, episodic, or easily interdicted operations. LOC security and support enables effective management of the distribution system that permits on-time delivery of supplies and extends operational reach.

12-54. Where the force commander establishes the support base influences the course of a campaign and the support plan. Lodgments are generally established near key seaport or airport facilities. They need to allow easy access to strategic sealift and airlift, offer adequate space for dispersal and storage, facilitate transshipment of supplies, and be accessible to multiple LOCs. A key to the success of the CSS plan is the capability of the distribution system to receive, store, manage, maintain, issue, and move materiel and personnel to using activities and units at the right time. An effective distribution system allows commanders to generate and sustain the necessary combat power for each phase of the operation.

Adjusting the Factors

12-55. Commanders adjust and balance CSS factors based on their vision and intent. Commanders can enhance sustainability and extend operational reach by adjusting the scope of support provided. Some CSS functions can be deferred or performed at reduced levels. Doing this during force projection may allow combat forces to move up in the deployment flow. For example, laundry and bath services may be deferred during the early stages of force projection; however, doing this risks disease and adverse morale. Commanders consider such tradeoffs when deciding whether to adjust the scope of support.

12-56. Commanders may adjust the location of certain support activities and facilities to increase responsiveness and force sustainability. If automation and communication networks permit, commanders may require CSS units to perform portions of support functions, such as CSS management and administration, remotely—in an ISB, the main theater base, home station, or CONUS. Split-based operations help minimize the size of the deployed CSS force, reduce demands on LOCs, and increase force agility. The positioning of stocks, units, or other capabilities dedicated for a specific operation is another component of CSS reach operations. These stocks or units may be positioned at home station, an ISB, or another location within the theater of operations.

12-57. Commanders must make maximum use of all sources of support. Several factors can increase the availability of materiel, enhance responsiveness, and improve the flexibility and sustainability of operations. These factors include making effective use of theater support contracts (host nation support and contracted assets), support from other nations, and common user support to all services in theater. They also include efficient use of DOD and DA civilians, civilian contractors, and CSS reach capabilities.

12-58. Digital linkage of combat, CS, and CSS units allows positive control of CSS functions. Combined with reliable and responsive distribution networks, this enhanced asset visibility can achieve optimal stockage levels and

maximize CSS reach capabilities. The COP enables CSS operators to foresee requirements and enhances force commanders' confidence in CSS operations.

12-59. Adjusting CSS factors can entail risks. When necessary, commanders conduct a risk analysis to determine what CSS functions can be deferred, performed at a reduced level, or performed in alternative locations in the short term. Initially deferred functions can be enhanced through follow-on support or call-forward capabilities pre-positioned at an ISB or other location.

12-60. Commanders may also adjust factors related to materiel availability. Information systems and connectivity enhance asset visibility. Coupling them with an effective distribution system allows commanders to reduce in-theater stockage levels. Increasing a unit's basic load may extend its operational reach and sustainability. However, since a unit's upload capacity is normally fixed, increasing the basic load may reduce its agility. This can be offset by increasing the unit's transportation assets if the key concern is the threat of interruptions to the distribution system and LOCs rather than unit agility.

12-61. Commanders can adjust resupply by increasing lift or lift frequency, or by removing transfer bottlenecks at points such as ports, airfields, roads, and bridges. Commanders may also control resupply of critical items by setting priorities and controlling expenditure and supply rates. They can extend operational reach by establishing forward bases and depots and by improving the security and efficiency of LOCs. This is one example of how tactics and CSS interact. Gaining control of the communication centers, transportation nodes, and base areas necessary to support the force requires combat assets.

THE IMPACT OF TECHNOLOGY

12-62. To generate and sustain combat power, commanders conducting full spectrum operations require responsive, flexible, and modular CSS. Key to achieving proper CSS force mix is improved management of information and distribution systems. Technology advances in asset visibility, communications, C2, and distribution methods have increased CSS reach and enable the CSS system to provide rapid throughput with a reduced CSS footprint. Increasing throughput results in faster force projection and reduction of the overall demand for CSS in theater.

12-63. Developing CSS technology will create CSS organizations that are modular, have asset visibility, and are more responsive to the commander's CSS requirements. Technological developments focus on such items as—

- Precision and common-caliber munitions.
- Common chassis family of vehicles and ultrareliable equipment.
- Support vehicles with on-board upload and download capabilities.

Technology continues to evolve, depending on funding and available resources. Developing and fielding new CSS technologies will enable the commander to generate and sustain combat power faster and more decisively than before. Commanders prepare to leverage the capabilities of new CSS technology when it enters the force.

Leveraging Technology—Real-time CSS

During Operations Desert Shield and Desert Storm in the early 1990s, logistic data moved on floppy diskettes manually transported between computers at distant locations, a better method than before but time and resource consuming.

By the late 1990s, logisticians benefited from incredible technological leaps. During Operation Joint Endeavor in 1995, 5th Signal Command created a robust communications architecture that linked CSS supporting units to the theater logistics base in Germany. CSS soldiers used in-transit visibility to track equipment, personnel, and supplies. CSS units used the Standard Army Management Information System (STAMIS) to exchange information near instantaneously. For the first time, commanders and logisticians accessed, planned, and directed CSS at every level.

During Operation Joint Endeavor, radio frequency interrogators tracked equipment shipped from CONUS and throughout the theater and could identify contents within containers. One such container arrived in Taszar, Hungary, releasing a noxious smell, a potentially unsafe situation that required opening the container. Personnel from the freight forwarding activity used radio frequency interrogator technology to read the tag and discovered the presence of powdered battery acid and petroleum products. Forewarned, the CSS soldiers took appropriate measures, and upon opening the container discovered that the acid carton had ruptured during shipment.

In addition to radio frequency interrogators, logisticians used the Defense Transportation Reporting and Control System (DTRACS) to locate troop trains and convoys. DTRACS enabled commanders to track soldiers and equipment, enhance force protection, and redirect assets on the move. Less than five years after the Gulf War, technology significantly enhanced logisticians' capabilities to support Army forces with greater accuracy and speed.

Source Notes

These are the sources quoted or paraphrased in this publication. They are listed by page number. Where material appears in a paragraph, both page and paragraph number are listed. Boldface indicates the titles of historical vignettes.

PART ONE—THE ENVIRONMENT OF OPERATIONS

Chapter 1—The Army and the Role of Land Power

- 1-1 “The Army’s deployment...”: “The Army Vision: Soldiers On Point for the Nation...Persuasive in Peace, Invincible in War,” [Online]. Available: <http://www.hqda.army.mil/ocsa/vision.htm>
- 1-2 “You can fly...”: T.R. Fehrenbach, *This Kind of War: A Study in Unpreparedness* (New York: Mac-Millan, 1963), 427.
- 1-3 **The Army—A Proud History of Full Spectrum Operations**: Daniel P. Bolger, *Americans at War, 1975–1986: An Era of Violent Peace* (Novato, Calif.: Presidio Press, 1988), and *Savage Peace: Americans at War in the 1990s* (Novato, Calif.: Presidio Press, 1995); Russell F. Weigley, *History of the United States Army* (Bloomington: Univ. of Indiana Press, 1984).
- 1-10 **Task Force Eagle in Bosnia**: Stanley F. Cherrie, “Task Force Eagle,” *Military Review* (Jul.–Aug. 1997) (hereafter cited as “TF Eagle”) 63–72.
- 1-13 **Technology Aids Soldiers—Operation Desert Hammer VI**: Alice F. Edwards, “High-Tech Training in the High Desert,” *Army Trainer* (Summer 1994): 24–33.
- 1-17 “The whole of military activity...”: Carl von Clausewitz, *On War*, ed. and trans. Michael Howard and Peter Paret (Princeton, N.J.: Princeton Univ. Press, 1984) (hereafter cited as *On War*), 95.
- 1-18 “No man is a leader...”: Anonymous, *Warriors’ Words: A Dictionary of Military Quotations*, comp. Peter G. Tsouras (London: Arms and Armour Press, 1992) (hereafter cited as Tsouras), 236.

Chapter 2—Unified Action

- 2-1 “[S]eparate ground, sea, and...”: Dwight D. Eisenhower, *Public Papers of the Presidents of the United States: Dwight D. Eisenhower, 1958* (Washington, D.C., Government Printing Office, 1959), 274.
- 2-2 **Unified Action in Haiti**: Walter E. Kretchik, Robert F. Baumann, and John T. Fishel, *Invasion, Intervention, “Intervasion,” A Concise History of the United States Army in Operation Uphold Democracy* (Fort Leavenworth, Kans.: US Army Command and General Staff College Press, 1998) (hereafter cited as *Intervasion*), 27–146.
- 2-6 **Operation Assured Response—An Example of Joint Synergy**: Gil High, “Liberia Evacuation,” *Soldiers* (Jul. 1996): 4–5; John W. Partin and Rob Rhoden, *Operation Assured Response: SOCEUR’s NEO in Liberia, April 1996* (Headquarters, US Special Operations Command, History and Research Office, Sep. 1997).
- 2-6 “Unless limited by the establishing directive...”: JP 0-2, *Unified Action Armed Forces (UNAAF)*, 24 Feb. 1995, III-11.
- 2-15 “The written basis for allied unity...”: Dwight D. Eisenhower, *The Papers of Dwight David Eisenhower*, vol. 3, *The War Years*, ed. Alfred D. Chandler Jr. (Baltimore: The Johns Hopkins Press, 1970), 1420.
- 2-24 2-86. “DOD Principles of Information,” (Washington, D.C.: Government Printing Office, 01 Apr. 1997), [Online]. Available <http://www.defenselink.mil/admin/about.html#PrinInfo>

Chapter 3—Strategic Responsiveness

- 3-0 “Generally, he who occupies...”: Sun Tzu, *The Art of War*, trans. Samuel B. Griffith (London: Oxford University Press, 1963), 96.
- 3-3 **Responsive and Agile—Operation Uphold Democracy:** *Intervasion*, 27–146.
- 3-14 **Precision and Speed—VII Corps Deploys to Southwest Asia:** “VII Corps Debarkation and Onward Movement, Desert Shield/Storm After Action Report” (Headquarters, 1st Infantry Division, Forward, May 1991), 1–49.

PART TWO—FOUNDATIONS OF FULL SPECTRUM OPERATIONS

Chapter 4—Fundamentals of Full Spectrum Operations

- 4-2 “The art of war...”: Frederick the Great in Tsouras, 337.
- 4-5 **Close Combat at Landing Zone X-Ray:** Harold G. Moore and Joseph L. Galloway, *We Were Soldiers Once...And Young, Ia Drang: The Battle That Changed the War in Vietnam* (New York: Random House, 1992), 89–90, 189–190.
- 4-7 **Operational Maneuver and Fires—Operation Desert Storm:** Robert H. Scales, *Certain Victory: The US Army in the Gulf War* (Washington, D.C.: Office of the Chief of Staff, US Army, 1993; reprint, Fort Leavenworth, Kans.: US Army Command and General Staff College Press, 1994) (hereafter referred to as *Certain Victory*); Richard M. Swain, *“Lucky War”: Third Army in Desert Storm* (Fort Leavenworth, Kans.: US Army Command and General Staff College Press, 1994) (hereafter referred to as *Lucky War*).
- 4-9 **Field Discipline—Preventive Medicine in Combat:** David F. Trask, *The War With Spain in 1898* (New York: MacMillan, 1981), 161; Thomas Donnelly, Margaret Roth, and Caleb Baker, *Operation Just Cause: The Storming of Panama* (New York: Lexington Books, 1991) (hereafter referred to as *Storming of Panama*); John R. Ballard, *Upholding Democracy: The United States Campaign in Haiti, 1994–1997* (West Port, Conn.: Praeger, 1998).
- 4-11 **Information Modernization—AH-64D Longbow:** Office of the Secretary of the Army (Research Development Activity), “United States Army Weapons Systems 1999” (Department of the Army, The Pentagon, 1999), 125.
- 4-12 “No one starts a war...” Carl von Clausewitz in *On War*, 579.

Chapter 5—Battle Command

- 5-1 ... “[It is] essential...”: The Infantry Journal. *Infantry in Battle*, 2d ed. (Washington, D.C.: Infantry Journal, 1939; reprint, Fort Leavenworth, Kans.: US Army Command and General Staff College, 1981), 14.
- 5-5 “You can ask me for anything you like, except time...”: Napoleon in Tsouras, 434.
- 5-13 **Experience and Innovation on Grenada:** Joint History Office, *Operation Urgent Fury: The Planning and Execution of Joint Operations in Grenada 12 October–2 November 1983* (Washington, D.C.: Office of the Joint Chiefs of Staff, 1997).
- 5-14 **Commander’s Intent and Sherman’s “March to the Sea”:** U.S. Grant, *Personal Memoirs of U.S. Grant*, vol. 2, (New York: Charles L. Webster and Company, 1886) (hereafter cited as Grant), 130–132.
- 5-15 **Planning Guidance—Grant and Thomas at Chattanooga:** Grant, 53–54. Grant’s memoirs reflect his rank as lieutenant general. However, he was a major general at the time.
- 5-18 “Modern land warfare is tough...”: Frederick M. Franks, Jr., electronic mail to Director, School of Advanced Military Studies, US Army Command and General Staff College, 18 Apr. 2000 (Fort Leavenworth, Kans.: Combined Arms Research Library Archives).

Chapter 6—Conducting Full Spectrum Operations

- 6-1 “I think the time has come...”: William T. Sherman in Shelby Foote, *The Civil War, A Narrative*, vol. 3, *Red River to Appomattox* (New York: Random House, 1974; reprint, New York: Vintage Books, 1986) (hereafter cited as *Civil War*), 715.
- 6-3 6-7. “no plan...extends...”: Helmuth von Moltke, *Moltke’s Military Works*, vol. 4, *War Lessons*, Part I, “Operative Preparations for Battle” (Berlin: Mittler, 1911), quoted in Hans Delbrück, *History of*

- the Art of War within the Framework of Political History*, vol. 4, *The Modern Era*, trans. by Walter J. Renfroe Jr. (Westport, Conn.: Greenwood Press, 1985), 425.
- 6-3 6-7. "...one makes plans to fit circumstances...": George S. Patton Jr., *The Patton Papers*, vol. 2, 1940–1945, ed. Martin Blumenson (Boston: Houghton Mifflin Co., 1974), 648.
- 6-4 **Change of Plans at Normandy**: Historical Division, *Utah Beach to Cherbourg: 6 June–27 June 1944* (Washington, DC: History Division, Department of the Army, 1949).
- 6-8 **Home Station, Predeployment, and Deployment Training**: "TF Eagle", 63–64; US Army Component Command Historian Notes (USAREUR Forward, Feb.–Aug. 1996).
- 6-11 "...I am heartily tired...": *Civil War*, 185.

PART THREE—CONDUCTING DECISIVE FULL SPECTRUM OPERATIONS

Chapter 7—Offensive Operations

- 7-2 "In war the only...": George S. Patton Jr. in Tsouras, 293.
- 7-5 **Surprise—Coup de Main in Panama**: *Storming of Panama*.
- 7-8 **Audacity—Turning Movement at Inchon**: Department of the Army, *Korea 1950*, (Washington, D.C.: Center of Military History, 1997) (hereafter cited as *Korea*), 13–17, 147–151.
- 7-9 **Desert Storm—A Decisive Offensive Operation**: Frank N. Schubert and Theresa L. Kraus, gen. eds., *The Whirlwind War: The United States Army in Operations Desert Shield and Desert Storm* (Washington, DC: Center of Military History, 1995), 173–205.
- 7-12 7-35. Operation Chromite: *Korea*, 13–17, 147–151; *Joint Military Operations Historical Collection* (15 Jul. 1997), Chapter II.
- 7-21 7-65.the 1st Cavalry Division conducted feints in the Ruqi pocket...: *Certain Victory*, 200–207.

Chapter 8—Defensive Operations

- 8-1 "Little minds try to defend everything...": Frederick the Great, quoted in Hermann Foertsch, *The Art of Modern Warfare*, trans. by Theodore W. Knauth (New York: Oskar Piest, 1940), 68.
- 8-10 **Decisive Defensive Operations—Pusan, Korea**: John Toland, *In Mortal Combat: Korea, 1950–1953* (New York: William Morrow, 1991), 149–174; *Korea*, 77–84.
- 8-11 **Shaping Defensive Operations—2d SANG Brigade at Khafji**: *Lucky War*, 192–193; *Certain Victory*, 190–191.

Chapter 9—Stability Operations

- 9-1 "To defend and protect US national interests...": *National Military Strategy of the United States of America* (1997), executive summary, [Online]. Available <http://www.dtic.mil/jcs/nms>
- 9-4 **Ongoing Deterrence—Forward Presence in Korea**: John H. Tilelli Jr., "Joint/Combined Operations Are Integral to Korea's Defense," *Army* (Oct. 1999): 99–104.
- 9-7 **Stability Mission at Brcko**: *Stars and Stripes*, 28–30 Aug. 1997, European edition.
- 9-10 **Foreign Internal Defense in El Salvador**: Kimbra L. Fishel and Edwin G. Carr, "UN Peace Operations in El Salvador: The Manwaring Paradigm in a Traditional Setting," in *The Savage Wars of Peace: Toward A New Paradigm of Peace Operations*, ed. John T. Fishel (Boulder, Colo.: Westview Press, 1998), 41–56; "FID in Central America," historical vignette prepared by US Army Special Operations Command History Office, McDill Air Force Base, Fla., Dec. 1999, (Fort Leavenworth, Kans.: Combined Arms Research Library Archives); "Historical Vignette," prepared by US Army Special Warfare Center and School, Fort Bragg, N.C., 2000, (Fort Leavenworth, Kans.: Combined Arms Research Library Archives).
- 9-13 **Conventional Arms Control Operations—Task Force Eagle in Bosnia**: US Army, Europe, "Operation Joint Endeavor After Action Report" (Heidelberg: Headquarters, US Army, Europe, 1997), 2 vols. (hereafter cited as "Joint Endeavor AAR").
- 9-16 **Vietnam—A Case Study in US Military Involvement**: Andrew F. Krepinevich Jr., *The Army and Vietnam* (Baltimore: Johns Hopkins Univ. Press, 1986), 17–99.

Chapter 10—Support Operations

- 10-0 "Instead of thinking about warfighting agencies...": A.C. Zinni, quoted in JP 3-07, *Joint Doctrine for Military Operations Other Than War* (16 Jun. 1995), II-1.

- 10-2 **Refugee Processing—A Support Operation:** Grail L. Brookshire, "Refugee Crisis: Test of Army Versatility," *Army* (Nov. 1991): 45; Douglas Ide, "Keeping Up With the Numbers," *Soldiers* (Dec. 1994): 45–46; Gena Ellis, "Refuge in America," *Soldiers* (Aug. 1999): 17–19.
- 10-3 **JTF Support Hope—Foreign Humanitarian Assistance in Africa:** Daniel Schroeder, "Lessons of Rwanda: Joint Warfighting Doctrine in Operations Other Than War," *Armed Forces Journal International* (Dec. 1994): 32–33; Debra Arden and Carol Sobel, "Perspective on Rwanda Support, Commander of the 21st Theater Army Area Command Assesses his Command's Support for Operation Support Hope," *Army Logistician* (May–Jun. 1995): 4–6.
- 10-6 **JTF Andrew—Disaster Relief in the Continental United States:** Gordon R. Sullivan, "Hurricane Andrew: An After-Action Report," *Army* (Jan. 1993): 16–22.
- 10-14 **Measures of Effectiveness—Operation Support Hope:** John E. Lange, "Civilian-Military Cooperation and Humanitarian Assistance: Lessons from Rwanda," *Parameters* (Summer 1998): 106–122.

PART FOUR—ENABLING OPERATIONS

Chapter 11—Information Superiority

- 11-2 "To guess at the intention...": Napoleon, quoted in J.F.C. Fuller, *Memoirs of an Unconventional Soldier*, in Tsouras, 257.
- 11-4 "Nations do not go to war because they think war is safe...": *Lucky War*, 328.
- 11-5 **Information Superiority in the Gulf:** *Lucky War*, Chapters 3 and 7; Michael D. Burke (XVIII Airborne Corps war plans officer), notes and personal documents; "Iraq lost the war before...": S. Bogdanov, quoted in JP 3-13, *Joint Doctrine for Information Operations* (9 Oct. 1998), II-15.
- 11-10 "You can never do too much reconnaissance.": Patton, 400.

Chapter 12—Combat Service Support

- 12-1 "Before a commander can even start thinking...": Martin Van Creveld, *Supplying War: Logistics From Wallenstein to Patton* (New York: Cambridge Univ. Press, 1977), 1.
- 12-11 **Contractor Support—Operations in the Balkans:** "Joint Endeavor AAR," xxii–xxiii, 126–128.
- 12-12 **Full Spectrum Support—22d Support Command in Southwest Asia:** William G. Pagonis and Michael D. Krause, "Theater Logistics in the Gulf War," *Army Logistician* (Jul.–Aug. 1992): 2–8; William L. Brame, "Planning Desert Storm Logistics," *Army Logistician* (May–Jun. 1992): 16–21.
- 12-20 **Leveraging Technology—Real-time CSS:** Deputy Chief of Staff for Logistics, US Army Europe and 7th Army, electronic mail to FM 3-0 writing team, US Army Command and General Staff College, 31 Mar. 2000 (Fort Leavenworth, Kans.: Combined Arms Research Library Archives).

Glossary

The glossary lists acronyms and terms with Army or joint definitions, and other selected terms. Where Army and joint definitions are different, (*Army*) follows the term. Terms for which FM 3-0 is the proponent manual (the authority) are marked with an asterisk (*) and followed by the number of the paragraph (§) or page where they are defined. For other terms, refer to the manual listed. JP 1-02 and FM 1-02 are posted in the Joint Electronic Library, which is available online and on CD-ROM.

- Use this URL to access JP 1-02 online: <http://www.dtic.mil/doctrine/jel/doddict/index.html>.
- Use this URL to access FM 1-02 online: http://www.dtic.mil/doctrine/jel/service_pubs/101_5_1.pdf.
- Follow this path to access JP 1-02 on the Joint Electronic Library CD-ROM: Mainmenu>Joint Electronic Library>DOD Dictionary.
- Follow this path to access FM 1-02 on the Joint Electronic Library CD-ROM: Mainmenu>Joint Electronic Library>Service Publications>Multiservice Pubs>FM 101-5-1.

73 Easting	a location in Iraq where the 2d ACR engaged the Tawakalna Division during the Gulf War	
AADC	area air defense commander	
AC	active component	
ACR	armored cavalry regiment	
ACSA	acquisition cross-service agreement	
ADADO	assistance division air defense officer	
ADCON	administrative control	
ADE	assistant division engineer	
administrative control	JP 1-02
administrative movement	JP 1-02
adversary	a person or group that is opposed to an Army force mission but is not engaging Army forces in combat operations	
*agility	¶4-58
alliance	JP 1-02
allocated forces	JP 5-0
ALO	air liaison officer	
*ambush	¶7-64

AMC	US Army Material Command	
AMEDD	US Army Medical Department	
amphibious objective area	JP 1-02
antiterrorism	JP 1-02
AO	area of operations	
AOR	area of responsibility	
apportioned forces	JP 5-0
*approach march	(Army).....	¶7-45
AR	Army Regulation	
area damage control	JP 1-02
*area defense	¶8-20
area of influence	JP 1-02
area of interest	JP 1-02
area of operations	JP 1-02
area of responsibility	JP 1-02
area security	FM 1-02
*ARFOR	¶2-38
ARNG	Army National Guard	
ARSOF	Army special operations forces	
ARVN	Army of the Republic of Vietnam	
ASCC	Army service component command	
*assessment	(Army).....	¶6-90
assigned forces	JP 5-0
*attack	¶7-53
augmentation forces	JP 1-02
avenue of approach	JP 1-02
base	(Army).....	FM 1-02
base cluster	(Army)	FM 1-02
base of operations	JP 1-02
*battle	¶2-12
*battle command	¶5-3
battle drill	FM 1-02
*battlefield organization	¶4-83
battle handover	FM 1-02

battle position	FM 1-02
battlespace	JP 1-02
BG	brigadier general	
block	FM 1-02
BOS	battlefield operating systems	
*branch	¶6-17
C2	command and control	
campaign	JP 1-02
canalize	(Army)	FM 1-02
CBRNE	chemical, biological, radiological, nuclear, and high-yield explosive	
CCIR	commander's critical information requirements	
CD-ROM	compact disk, read-only memory	
centers of gravity	JP 1-02
CIMIC	civil-military cooperation (NATO use only)	
civil affairs	(Army)	FM 1-02
CJCS	chairman of the Joint Chiefs of Staff	
CJCSI	Chairman of the Joint Chiefs of Staff Instruction	
CJCSM	Chairman of the Joint Chiefs of Staff Manual	
classes of supply (I-IX)	FM 1-02
*close area	¶4-96
*close combat	¶4-9
CM	consequence management	
CMO	civil-military operations	
CMOC	civil-military operations center	
COA	course of action	
coalition	JP 1-02
COCOM	combatant command (command authority)	
combatant command (command authority)	JP 1-02
combat health support	FM 1-02
combat power	JP 1-02
combat service support	(Army)	FM 1-02
*combat service support reach operations	¶12-4
combatting terrorism	JP 1-02

combat zone	JP 1-02
* combined arms	¶4-102
command	JP 1-02
command and control	JP 1-02
* commander’s critical information requirements	¶11-39
* commander’s intent	¶5-61
* common operational picture	¶11-43
communications zone	JP 1-02
COMMZ	communications zone	
component	JP 1-02
* concept of operations	¶6-19
contingency plan	(Army).....	FM 1-02
control measure	FM 1-02
CONUS	continental United States	
coordinating authority	JP 1-02
COP	common operational picture	
counterair	JP 1-02
* counterattack	(Army).....	¶7-61
counterdrug operations	JP 1-02
counterfire	JP 1-02
counterguerrilla operations	JP 1-02
counterinsurgency	JP 1-02
countermobility operations	FM 1-02
counterterrorism	JP 1-02
coup de main	JP 1-02
course of action	(Army).....	FM 1-02
cover	(Army).....	FM 1-02
CS	combat support	
CSG	corps support group (graphics)	
CSM	command sergeant major	
CSS	combat service support	
CUL	common user logistic/logistics	
* culminating point	¶5-38
DA	Department of the Army	

Dayton Accords	the agreements that established the General Framework Agreement for Peace in Bosnia and Herzegovina, signed on 21 November 1995, in Dayton, Ohio
decisive engagement	(Army) FM 1-02
*decisive operation ¶4-84
*decisive point ¶5-30 (This definition is being staffed in draft JP 3-0. If accepted, it will become a joint definition.)
decisive terrain FM 1-02
*deep area ¶4-98
defeat in detail	Defeat in detail is achieved by concentrating overwhelming combat power against separate parts of a force rather than defeating the entire force at once (see FM 3-90).
*defensive operations ¶1-48
*defensive information operations	(Army)..... page 11-17
delay JP 1-02, see delaying action
*demonstration	(Army) ¶7-66
deployment JP 1-02
*depth ¶4-61
destroy FM 1-02
deterrence JP 1-02
direct action JP 1-02
*direct approach ¶5-42
disease and nonbattle injury casualty JP 1-02
disrupt FM 1-02
DLA	Defense Logistics Agency
DNBI	disease and nonbattle injury
DOD	Department of Defense
DODD	Department of Defense Directive
domestic support operations JP 1-02
DS	direct support
DSO	domestic support operations
DTLOMS	doctrine, training, leader development, organizations, materiel, and soldiers
DTRACS	Defense Transportation Reporting and Control System
EA	engagement area (graphics)

EEFI	essential elements of friendly information	
electromagnetic pulse	(Army).....	FM 1-02
employment	JP 1-02
*encirclement	¶7-34
*end state	(Army).....	¶5-25
enemy	an individual or group engaging Army forces in combat	
*engagement	¶2-12
engagement area	FM 1-02
*envelopment	(Army).....	¶7-31
eny	enemy (graphics)	
essential elements of friendly information	FM 1-02
EW	electronic warfare	
executive agent	JP 1-02
exploitation	JP 1-02
*exterior lines	¶5-35
facility	(Army) a structure or location providing a work environment (This definition is being staffed with draft FM 6-0. If approved, it will become an Army definition.)	
FARP	forward arming and refueling point	
FEBA	forward edge of the battle area	
*feint	(Army).....	¶7-65
FEMA	Federal Emergency Management Agency	
FFIR	friendly force information requirements	
FHA	foreign humanitarian assistance	
FID	foreign internal defense	
firepower	JP 1-02
fires	JP 1-02
fire support	JP 1-02
fire support coordinating measure	(Army).....	FM 1-02
fix	(Army).....	FM 1-02
flexible deterrent option	JP 1-02
FLOT	forward line of own troops	
FM	field manual	
force projection	JP 1-02

*force protection	(Army) ¶4-22 (This definition is being staffed in draft JP 3-0. If accepted, it will become a joint definition.)
forces for	the “Forces for Unified Commands” memorandum, by which the secretary of defense assigns service forces to combatant commands (see JP 0-2)
*force tailoring ¶3-27
force tracking JP 1-02
*forcible entry ¶3-51 (This definition is being staffed in draft JP 3-18. If accepted, it will become a joint definition.)
foreign internal defense JP 1-02
forward arming and refueling point FM 1-02
forward boundary FM 1-02
forward edge of the battle area JP 1-02
forward line of own troops	(Army) FM 1-02
fragmentary order	(Army) FM 1-02
*fratricide ¶4-27
friendly force information requirements FM 1-02
*frontal attack	(Army) ¶7-40
FSCCL	fire support coordination line
FSCM	fire support coordinating measure
*full spectrum operations page 1-4
functional component command JP 1-02
G1	assistant chief of staff, personnel
G2	assistant chief of staff, intelligence
G3	assistant chief of staff, operations
G4	assistant chief of staff, logistics
G5	assistant chief of staff, civil affairs
GCCS	global command and control system
GEN	general
GS	general support
GSR	general support reinforcing
hazard JP 1-02
HCA	humanitarian and civic assistance
high-payoff target FM 1-02

home station	JP 1-02
hostile environment	JP 1-02, see operational environment
humanitarian and civic assistance	JP 1-02
IFOR	NATO Implementation Force (Bosnia)	
IG	inspector general	
IM	information management	
indications and warning	JP 1-02
* indirect approach	¶5-42
* infiltration	(Army).....	¶7-36
information	JP 1-02
information environment	JP 1-02
* information management	¶11-28
* information operations	(Army).....	page 11-16
* information superiority	(Army).....	¶11-1
* information systems	(Army).....	¶11-31
infrastructure	JP 1-02
initiative (individual)	FM 6-22
* initiative (operational)	¶4-51
INS	Immigration and Naturalization Service	
intelligence	JP 1-02
intelligence preparation of the battlefield	FM 1-02
interagency coordination	JP 1-02
interdiction	JP 1-02
* interior lines	¶5-35
* intermediate staging base	¶3-56
in-transit visibility	(Army).....	FM 1-02
IO	information operations	
IPB	intelligence preparation of the battlefield	
IPTF	International Police Task Force (Bosnia)	
IR	information requirements	
ISB	intermediate staging base	
ISR	intelligence, surveillance, and reconnaissance	
ISSA	interservice support agreement	
JFACC	joint force air component commander	

JFC	joint force commander	
JFLCC	joint force land component commander	
JOA	joint operations area	
joint force commander	JP 1-02
joint logistics over-the-shore	JP 1-02, see joint logistics over-the-shore operations
joint operation	JP 1-02
joint operations area	JP 1-02
joint rear area	JP 1-02
joint special operations area	JP 1-02
Joint Staff	JP 1-02
joint task force	JP 1-02
JOPES	Joint Operation Planning and Execution System	
JP	joint publication	
JTF	joint task force	
key terrain	JP 1-02
lead agency	JP 1-02
leadership	FM 1-02
level III	FM 1-02, see rear area threat levels
limit of advance	FM 1-02
line of communications	JP 1-02
*lines of operations	¶5-33
LOC	line of communication	
local security	FM 1-02
LOGCAP	Logistics Civil Augmentation Program	
LTG	lieutenant general	
M-16	an Army assault rifle	
M1A1	the main battle tank used by Army forces during the Gulf War	
MACA	military assistance to civil authorities	
MACOM	major Army command	
MACV	Military Assistance Command–Vietnam	
*main effort	¶4-93
*major operation	¶2-5
maneuver	JP 1-02
marshaling area	JP 1-02

maritime power projection	JP 1-02
M/C/S	mobility, countermobility, survivability	
*meeting engagement	(Army).....	¶7-51
METL	mission essential task list	
METT-TC	mission, enemy, terrain and weather, troops and support available, time available, civil considerations (the major factors considered during mission analysis)	
military department	JP 1-02
mission	(Army).....	FM 1-02
MG	major general	
MI	military intelligence	
*mobile defense	(Army).....	¶8-16
mobility operations	FM 1-02
mobilization	JP 1-02
MOOTW	military operations other than war	
movement control	JP 1-02
*movement to contact	¶7-46
MP	military police	
MRX	mission rehearsal exercise	
MTW	major theater war	
National Command Authorities	JP 1-02
NATO	North Atlantic Treaty Organization	
NBC	nuclear, biological, and chemical	
NCA	National Command Authorities	
near real-time	JP 1-02
NEO	noncombatant evacuation operation	
neutralize	(Army).....	FM 1-02
NGO	nongovernmental organization	
NKPA	North Korean People's Army	
noncombatant evacuation operations	JP 1-02
nongovernmental organization	JP 1-02
	(In FM 3-0, nongovernmental organizations include private voluntary organizations.)	
NTC	National Training Center	
NVA	North Vietnamese Army	

obj	objective (graphic)	
*offensive information operations (Army)		page 11-17
*offensive operations		¶1-48
OPCON	operational control	
operation		JP 1-02
*operational approach		¶5-42
operational art		JP 1-02
operational control		JP 1-02
*operational fires		¶4-13
*operational framework		¶4-69
operational level of war		JP 1-02
*operational pause		¶5-43
*operational picture		¶11-43
*operational reach		¶5-41
operation plan		JP 1-02
operations security (Army)		FM 1-02
OPSEC	operations security	
order of battle		JP 1-02
overwatch		FM 1-02
PAO	public affairs officer	
peace building		JP 1-02
peace enforcement operations		JP 1-02
peacekeeping		JP 1-02
peacemaking		JP 1-02
peace operations		JP 1-02
*peacetime military engagement		¶9-5
*penetration (Army)		¶7-37
PEO	peace enforcement operations	
permissive environment		JP 1-02, see operational environment
*phase		¶6-13
PIR	priority intelligence requirements	
PKO	peacekeeping operations	
*planning		¶6-3
PME	peacetime military engagement	

PO	peace operations	
POD	port of debarkation	
POLAD	political advisor	
power projection	JP 1-02
*preparation	¶6-22
preventive diplomacy	JP 1-02
priority intelligence requirements	JP 1-02
*protection	¶4-20
PSYOP	psychological operations	
public affairs	JP 1-02
pursuit	JP 1-02
R	reinforcing	
raid	JP 1-02
RC	reserve components (the Army National Guard and US Army Reserve)	
real-time	JP1-02
*rear area	(Army).....	¶4-99
reconnaissance	JP 1-02
reconstitution	FM 1-02
redeployment	JP 1-02
regeneration	FM 1-02
*relevant information	¶11-32
reorganization	FM 1-02
reserve	JP 1-02
response force	(Army).....	FM 1-02
retirement	JP 1-02
*retrograde	(Army).....	¶8-22
*risk management	(Army).....	¶6-20
ROE	rules of engagement	
ROK	Republic of Korea	
RSO&I	reception, staging, onward movement, and integration	
rules of engagement	JP 1-02
SANG	Saudi Arabian National Guard	
sea control operations	JP 1-02

*search and attack ¶7-50
security assistance JP 1-02
security operations FM 1-02
*sequel ¶6-18
service component command JP 1-02
*shaping operations ¶4-86
show of force JP 1-02
*situational understanding ¶11-46
SJA	staff judge advocate
SMART	special medical augmentation response teams
SOF	special operations forces
SOP	standing operating procedure
*spoiling attack	(Army) ¶7-60
spt	support (graphics)
SSC	smaller-scale contingency
*stability operations ¶1-48
staging area JP 1-02
standing operating procedure JP 1-02
Stat.	<i>Statutes at Large</i>
*strategy	(Army) ¶2-4
strike JP 1-02
*striking force page 8-5
strong point	(Army) FM 1-02
subunified command JP 1-02, see subordinate unified command
*supporting distance page 7-17
*supporting range page 7-17
*support operations ¶1-48
surveillance JP 1-02
survivability FM 1-02
survivability operations FM 1-02
*sustaining operation ¶4-90
sustainment JP 1-02
*synchronization ¶4-65
T-72	a Russian/Soviet-built main battle tank

TACON	tactical control	
tactical assembly area	JP 1-02
tactical combat force	JP 1-02
tactical control	JP 1-02
*tactical road march	¶7-45
*tactics	(Army).....	¶2-12
*task organization	¶4-101
*task organizing	¶4-101
TCF	tactical combat force	
*tempo	¶5-54
TEP	theater engagement planning/plan	
terrain management	FM 1-02
terrorism	JP 1-02
TF	task force	
theater	JP 1-02
theater of operations	JP 1-02
theater of war	JP 1-02
throughput	JP 1-02
Title 10 responsibilities	responsibilities placed on the Army by Title 10, US Code	
TPFDD	time-phased force and deployment data	
TSC	theater support command	
turn	FM 1-02
*turning movement	(Army).....	¶7-35
UN	United Nations	
uncertain environment	JP 1-02, see operational environment
unconventional warfare	JP 1-02
unified action	JP 1-02
unified command	JP 1-02
*urban operations	¶6-76
URL	uniform resource locator	
US	United States	
USAMEDCOM	US Army Medical Command	
USC	United States Code	
USCENTCOM	US Central Command	

USEUCOM	US European Command	
USJFCOM	US Joint Forces Command	
*versatility	¶4-67
warning order	JP 1-02
weapons of mass destruction	JP 1-02
withdrawal	JP 1-02
WMD	weapons of mass destruction	

Bibliography

The bibliography lists field manuals by new number followed by old number.

DOCUMENTS NEEDED

These documents must be available to the intended users of this publication.

JP 1-02. *Department of Defense Dictionary of Military and Associated Terms*. Available online at <http://www.dtic.mil/doctrine/jel/doddict/>

FM 1-02 (101-5-1). *Operational Terms and Graphics*. 30 Sep. 1997.

READINGS RECOMMENDED

These sources contain relevant supplemental information.

JOINT PUBLICATIONS

Most joint publications are available online at <http://www.dtic.mil/doctrine/jel/>

(S) CJCSI 3121.01A. *Standing Rules of Engagement for US Forces (U)*. 01 Sep. 1999.

CJCSM 3113.01. *Theater Engagement Planning*. 01 Feb. 1998.

CJCSM 3500.04B. *Universal Joint Task List*. 01 Oct. 1999.

Joint Doctrine Encyclopedia. 16 Jul. 1997.

Joint Military Operations Historical Collection. 15 Jul. 1997.

JP 0-2. *Unified Action Armed Forces (UNAAF)*. 24 Feb. 1995.

JP 1-0. *Doctrine for Personnel Support to Joint Operations*. 19 Nov. 1998.

JP 1-02. *Department of Defense Dictionary of Military and Associated Terms*. Available online at <http://www.dtic.mil/doctrine/jel/doddict/>

JP 1-05. *Religious Ministry Support for Joint Operations*. 26 Aug. 1996.

JP 1-06. *Joint Tactics, Techniques, and Procedures for Financial Management During Joint Operations*. 22 Dec. 1999.

JP 2-0. *Doctrine for Intelligence Support to Joint Operations*. 09 Mar. 2000.

JP 3-0. *Doctrine for Joint Operations*. 1 Feb. 1995.

JP 3-07. *Joint Doctrine for Military Operations Other Than War*. 16 Jun. 1995.

JP 3-07.1. *Joint Tactics, Techniques, and Procedures for Foreign Internal Defense (FID)*. 26 Jun. 1996.

JP 3-07.2. *Joint Tactics, Techniques, and Procedures for Antiterrorism*. 17 Mar. 1998.

- JP 3-07.3. *Joint Tactics, Techniques, and Procedures for Peace Operations*. 12 Feb. 1999.
- JP 3-07.4. *Joint Counterdrug Operations*. 17 Feb. 1998.
- JP 3-07.5. *Joint Tactics, Techniques, and Procedures for Noncombatant Evacuation Operations*. 30 Sep. 1997.
- JP 3-07.7. *Joint Tactics, Techniques, and Procedures for Domestic Support Operations*. TBP.
- JP 3-08. *Interagency Coordination During Joint Operations*. 2 volumes. 9 Oct. 1996.
- JP 3-09. *Doctrine for Joint Fire Support*. 12 May 1998.
- JP 3-11. *Joint Doctrine for Operations in Nuclear, Biological, and Chemical (NBC) Environments*. 11 Jul. 2000.
- JP 3-13. *Joint Doctrine for Information Operations*. 9 Oct. 1998.
- JP 3-14. *Joint Doctrine for Space Operations*. TBP.
- JP 3-16. *Joint Doctrine for Multinational Operations*. 05 Apr. 2000.
- JP 3-18. *Joint Doctrine for Forcible Entry Operations*. TBP.
- JP 3-33. *Joint Force Capabilities*. 13 Oct. 1999.
- JP 3-35. *Joint Deployment and Redeployment Operations*. 7 Sep. 1999.
- JP 3-53. *Doctrine for Joint Psychological Operations*. 10 Jul. 1996.
- JP 3-54. *Joint Doctrine for Operations Security*. 24 Jan. 1997.
- JP 3-55. *Doctrine for Reconnaissance, Surveillance, and Target Acquisition Support for Joint Operations*. 14 Apr. 1993.
- JP 3-57. *Doctrine for Joint Civil Affairs*. 21 Jun. 1995.
- JP 3-58. *Joint Doctrine for Military Deception*. 31 May 1996.
- JP 3-59. *Joint Doctrine, Tactics, Techniques, and Procedure for Meteorological and Oceanographic Support*. 23 Mar. 1999.
- JP 3-60. *Joint Doctrine for Targeting*. TBP.
- JP 3-61. *Doctrine for Public Affairs in Joint Operations*. 14 May 1997.
- JP 4-0. *Doctrine for Logistic Support of Joint Operations*. 06 Apr. 2000.
- JP 4-01. *Joint Doctrine for the Defense Transportation System*. 17 Jun. 1997.
- JP 4-01.6. *Joint Tactics, Techniques, and Procedures for Joint Logistics Over the Shore*. 12 Nov. 1998
- JP 4-01.8. *Joint Tactics, Techniques, and Procedures for Joint Reception, Staging, Onward Movement, and Integration*. 13 Jun. 2000.
- JP 4-02. *Doctrine for Health Service Support in Joint Operations*. 26 Apr. 1995.
- JP 4-03. *Joint Bulk Petroleum Doctrine*. 25 Jul. 1995.
- JP 4-04. *Joint Doctrine for Civil Engineering Support*. 26 Sep. 1995.

- JP 4-05. *Joint Doctrine for Mobilization Planning*. 22 Jun. 1995.
- JP 4-06. *JTTP for Mortuary Affairs in Joint Operations*. 28 Aug. 1996.
- JP 4-07. *Joint Tactics, Techniques, and Procedures for Common User Logistics During Joint Operations*. TPB.
- JP 4-08. *Joint Doctrine for Logistic Support of Multinational Operations*. TBP.
- JP 5-0. *Doctrine for Planning Joint Operations*. 13 Apr. 1995.
- JP 5-03.1. *Joint Operation Planning and Execution System, Volume I (Planning and Procedures)*. 04 Aug. 1993.

ARMY PUBLICATIONS

Most Army doctrinal publications are available online at
<http://155.217.58.58/atdls.htm>

- AR 71-9. *Materiel Requirements*. 30 Apr. 1997. Available online at
http://books.usapa.belvoir.army.mil/cgi-bin/bookmgr/BOOKS/R71_9/CCONTENTS
- DA Memo 10-1. *Executive Agent Responsibilities assigned to the Secretary of the Army*. 15 Jan. 1997.
- FM 1 (100-1). *The Army*. 14 Jun. 1994.
- FM 1-0 (12-6). *Personnel Doctrine*. 09 Sep. 94.
- FM 1-04 (27-100). *Legal Support to Operations*. 01 Mar. 2000.
- FM 1-05 (16-1). *Religious Support*. 26 May 1995.
- FM 1-06 (14-100). *Financial Management Operations*. 07 May 1997.
- FM 1-08 (12-50). *U.S. Army Bands*. 15 Oct. 1999.
- FM 2-0 (34-1). *Intelligence and Electronic Warfare Operations*. 27 Sep. 1994.
- FM 2-01.3 (34-130). *Intelligence Preparation of the Battlefield*. 08 Jul. 1994.
- FM 2-33.2 (34-81). *Weather Support for Army Tactical Operations*. 31 Aug. 1989.
- FM 3-01.94 (44-94). *Army Air and Missile Defense Command Operations*.
31 Mar. 2000.
- FM 3-04.500 (1-500). *Army Aviation Maintenance*. 27 Jan. 1995.
- FM 3-05 (100-25). *Doctrine for Army Special Operations Forces*. 01 Aug. 1999.
- FM 3-05.30 (33-1). *Psychological Operations*. 01 Jun. 2000.
- FM 3-06 (90-10). *Military Operations on Urbanized Terrain (MOUT) (How to Fight)*. 15 Aug. 1979.
- FM 3-07 (100-20). *Military Operations in Low Intensity Conflict*. 05 Dec. 1990.
When revised, FM 3-07 will be retitled *Stability Operations and Support Operations*.
- FM 3-07.2. *Force Protection*. TBP.
- FM 3-07.3 (100-23). *Peace Operations*. 30 Dec. 1994.

- FM 3-07.6 (100-23-1). *HA—Multiservice Procedures for Humanitarian Assistance Operations*. 31 Oct. 1994.
- FM 3-07.7 (100-19). *Domestic Support Operations*. 01 Jul. 1993.
- FM 3-09 (6-20). *Fire Support in the AirLand Battle*. 17 May 1988.
- FM 3-11 (3-100). *Chemical Operations Principles and Fundamentals*. 08 May 1996.
- FM 3-11.4 (3-4). *NBC Protection*. 29 May 1992.
- FM 3-11.14 (3-14). *Nuclear, Biological, and Chemical (NBC) Vulnerability Analysis*. 12 Nov. 1997.
- FM 3-13 (100-6). *Information Operations*. 27 Aug. 1996.
- FM 3-14 (100-18). *Space Support to Army Operations*. 20 Jul. 1995.
- FM 3-16 (100-8). *The Army in Multinational Operations*. 24 Nov. 1997.
- FM 3-34.250 (5-104). *General Engineering*. 12 Nov. 1986.
- FM 3-35 (100-17). *Mobilization, Deployment, Redeployment, Demobilization*. 28 Oct. 1992.
- FM 3-35.1 (100-17-1). *Army Pre-Positioned Afloat Operations*. 27 Jul. 1996.
- FM 3-35.2 (100-17-2). *Army Pre-Positioned Land*. 16 Feb. 1999.
- FM 3-35.5 (100-17-5). *Redeployment*. 29 Sep. 1999.
- FM 3-55. *Reconnaissance Operations*. TBP.
- FM 3-57 (41-10). *Civil Affairs Operations*. 11 Jan. 1993.
- FM 3-60 (6-20-10). *Tactics, Techniques, and Procedures for the Targeting Process*. 08 May 1996.
- FM 3-90. *Tactics*. TBP.
- FM 3-100.7 (100-7). *Decisive Force: The Army in Theater Operations*. 31 May 1995.
- FM 3-100.11 (100-11). *Force Integration*. 15 Jan. 1998.
- FM 3-100.14 (100-14). *Risk Management*. 23 Apr. 1998.
- FM 3-100.16 (100-16). *Army Operational Support*. 31 May 1995. FM 3-100.16 will be superseded by portions of FM 3-100.7 and FM 4-0 when these manuals are republished.
- FM 3-100.21 (100-21). *Contractors on the Battlefield*. 26 Mar. 2000.
- FM 3-100.22 (100-22). *Installation Management*. 11 Oct. 1994.
- FM 3-100.38 (100-38). *UXO Multiservice Procedures for Operations in an Unexploded Ordnance Environment*. 10 Jul. 1996.
- FM 4-0 (100-10). *Combat Service Support*. 03 Oct. 1995.
- FM 4-01 (55-1). *Transportation Operations*. 03 Oct. 1995.
- FM 4-01.4 (100-10-1). *Theater Distribution*. 01 Oct. 1999.

- FM 4-01.8 (100-17-3). *Reception, Staging, Onward Movement, and Integration*. 17 Mar. 1999.
- FM 4-02 (8-10). *Health Service Support in a Theater of Operations*. 01 Mar. 1991.
- FM 4-20 (10-1). *Quartermaster Principles*. 11 Aug. 1994.
- FM 4-30.2 (9-43-1). *Maintenance Operations and Procedures*. 21 Feb. 1997.
- FM 4-30.11 (21-16). *Unexploded Ordnance (UXO) Procedures*. 30 Aug. 1994.
- FM 4-30.12 (9-15). *Explosive Ordnance Disposal Service and Unit Operations*. 08 May 1996.
- FM 4-93.4 (63-4). *Combat Service Support Operations—Theater Army Area Command*. 24 Sep. 1984.
- FM 4-100.2 (100-10-2). *Contracting Support on the Battlefield*. 04 Aug. 1999.
- FM 4-100.9 (100-9). *Reconstitution*. 13 Jan. 1992.
- FM 5-0 (101-5). *Staff Organizations and Operations*. 31 May 1997. When revised, FM 5-0 will be retitled *Planning*.
- FM 6-0. *Command and Control*. TBP.
- FM 6-22 (22-100). *Army Leadership*. 31 Aug. 1999.
- FM 7-0 (25-100). *Training the Force*. 15 Nov. 1988.
- FM 7-10 (25-101). *Battle Focused Training*. 30 Sep. 1990.
- FM 7-15. *Army Universal Task List (AUTL)*. TBP.

DEPARTMENT OF DEFENSE PUBLICATIONS

DOD Directives available online at <http://web7.whs.osd.mil/corres.htm>

- DOD Civil Disturbance Plan, Annex C (Concept of Operations), Appendix 8 (Special Instructions), 15 Feb. 1991; modified by Director of Military Support message 161639Z Jul. 96, Subject: Changes to DOD Civil Disturbance Plan—"Garden Plot." Available online at <http://freddie.forscom.army.mil/maca/Word/GardenPlot.doc>
- DODD 3025.15. *Military Assistance to Civil Authorities*. 18 Feb. 1997.
- DODD 3100.10. *Space Policy*. 09 Jul. 1999.
- DODD 5100.1. *Functions of the Department of Defense and Its Major Components*. 25 Sep. 1987.
- DODD 5100.46. *Foreign Disaster Relief*. 4 Dec. 1975.
- DODD 5160.54. *Critical Asset Assurance Program (CAAP)*. 20 Jan. 1998.
- DODD 5525.5. *DOD Cooperation with Civilian Law Enforcement Officials*. 15 Jan. 1986.
- "DOD Principles of Information." Washington, D.C.: Government Printing Office, 01 Apr. 1997. Available online at <http://www.defenselink.mil/admin/about.html#PrinInfo>

National Military Strategy of the United States of America, 1997. Available online at <http://www.dtic.mil/jcs/nms>

PUBLIC LAWS AND OTHER PUBLICATIONS

The United States Code is available online at <http://uscode.house.gov/usc.htm>

Arms Export Control Act (Public Law 90-629, Oct. 22, 1968, [82 Stat. 1320]; see Title 22 USC, section 2751, Short Title note).

Authority to Use Army and Air National Guard in Certain Counterdrug Operations (Title 32 USC, section 112).

Civil Military Cooperation Action Program (Title 10 USC, section 401).

Defense Against Weapons of Mass Destruction Act of 1996 (Public Law 104-201, section xiv [110 Stat. 2422]). Available online at <http://www.access.gpo.gov/nara/publaw/104publ.html>

Federal Response Plan. Available online at <http://www.fema.gov/r-n-r/frp>

Foreign Assistance Act of 1961 (Public Law 87-195, Sept. 4, 1961, [75 Stat. 424]; see Title 22 USC, section 2151, Short Title note).

Goldwater-Nichols Department of Defense Reorganization Act of 1986 (Title 10 USC, Subtitle A, Part I, Chapter 5). Available online at http://dtic.mil/jcs/core/title_10.html

Insurrection Act (Title 10 USC, Chapter 15).

Military Support for Civilian Law Enforcement Agencies (Title 10 USC, sections 371-382, Chapter 18).

National Security Act of 1947 (61 Stat. 495, chapter 343; see Title 50 USC, section 401, Short Title note).

National Security Decision Directive 221, *Narcotics and National Security*, 08 Apr. 1986.

Posse Comitatus Act (Title 18 USC, section 1385).

Robert T. Stafford Disaster Relief and Emergency Assistance Act (Title 42 USC, sections 5142–5203).

Title 10 USC, Annex B, section 3013 (responsibilities of the secretary of the Army).

Index

Entries are by paragraph number unless page is specified.

A

- ADCON, 2-34, 2-36, 4-104
- administrative movement, 7-45
- agility, 3-12, 4-58–4-60, 12-58
 - force tailoring and, 4-101
 - hasty attacks and, 7-55
 - lines of operations and, 5-34
 - movement to contact and, 7-46
 - offensive planning and, 7-89
 - operational, 4-59
 - reconstitution and, 6-85
 - simultaneous operations and, 5-45
 - split-based operations and, 12-54
 - synchronization and, 4-65
 - tactical, 4-60
 - task organization and, 4-101
 - versatility and, 4-67
- air and missile defense, 2-74, 4-23
- air assault, 3-53, 7-11, 7-32
- air defense, 4-23, 5-68
- Air Force, 2-19–2-20, 2-72
- alliance, 2-42, 2-43, page 2-14
- ambush, 7-59, 7-64
- amphibious assault, 2-22, 3-52
- antiterrorism, 4-22, 9-37, 9-39
- AO, 2-16, 2-17, 2-19, 4-69, 4-74–4-76. *See also* contiguous AO; noncontiguous AO
 - area of influence and, 4-79
 - battlespace, relation to, 4-77, 4-78
 - civil considerations and, 5-18
 - CSS in, 12-47
 - CSS reach and, 12-4
 - defensive operations and, 8-8, 8-35, 8-53
 - home station and, 4-82
 - local population in, 6-72–6-74
 - mission and, 8-49
 - noncontiguous in envelopment, 7-32
 - nonlinear operations and, 7-28
 - offensive operations and, 7-2, 7-6
 - power projection platform, 4-82
 - simultaneous operations and, 5-45
 - spatial categories, 4-83
- AOR, 1-11, 9-5
 - combatant commander and, 1-11
 - COMMZ and, 4-70, 4-73
 - offensive planning and, 7-80
 - operational framework and, 4-70
 - theater of war and, 4-71
- apportioned forces, 2-28
- approach march, 7-45
- area defense, 8-14–8-15, 8-20–8-21
 - CSS and, 12-30
 - decisive operation and, 8-36
 - defensive execution and, 8-66
 - enemy penetration and, 8-68
 - linear operations and, 8-44
 - mobile defense and, 8-20
- area of interest, 4-21, 4-77, 4-79
- ARFOR, 2-29, 2-38–2-41
 - C2 options for, 2-37
 - CSS responsibilities, 12-9, 12-41
 - counterair missions, 2-77
 - force refinement and, 3-32
 - operational design, and, 5-44
 - responsibilities within joint force, 2-38–2-40
 - versatility of, 4-68
- arms control, disarming of belligerents and, 9-43–9-44
- Army METL, 1-5–1-23. *See also* METL
- ARNG, 2-28
 - civil disturbance operations and, 10-29
 - counterdrug operations and, 10-27
 - DSO and, 10-11
 - response to WMD incidents and, 10-20
 - support to civil law enforcement and, 10-24
- ARSOF, ARFOR C2 options and, 2-37, 2-40
 - capabilities of, 1-20
 - contribution to land force commanders, 2-26
 - FID and, 9-24
 - PME and, 1-12
 - stability operations, role in, 1-50
 - support to insurgencies and, 9-34
- ASCC, 1-20, 2-29, 2-35–2-36
 - ADCON and, 12-37
 - ARFOR C2 options and, 2-37
 - commander and, 2-36–2-37

ASCC (*continued*)

capabilities provided through, 1-20

CSS planning and preparation, 12-9

CUL support requirements and, 12-41

force augmentation and, 3-32

force refinement and, 3-32

lead service CS responsibility and, 2-36

providing theater-level support, 2-37, 2-41

Title 10 support responsibility and, 12-38

transition and, 6-80

assessment, 3-8, 5-23, 6-1, 6-20, 6-90–6-94, 7-81

attacks and, 7-53

battle damage, 5-65

commander's intent and, 5-61

defensive operations and, 8-46

end state and, 5-27

METT-TC and, 5-9

operational risk, 5-40

PO and, 9-20

tasks of, 6-91

assigned forces, 2-28, 2-31, page 2-9

assisted entry, 3-49

asymmetry, 1-41, 4-109–4-114

force protection and, 4-22

information and, 11-6

operational approach and, 5-40

potential threat to US forces, 1-25–1-29

security and, 4-46

surprise and, 4-47

synchronization of maneuver and fires, 4-14

attack, 5-30, 5-42, 7-53–7-65, 7-104

audacity, 6-31, 6-39, 6-59, 7-20

exploitation and, 7-77

fratricide avoidance and, 4-27

meeting engagement and, 7-52

offensive operations and, 7-8

pursuit and, 7-76

augmentation forces, 2-28, page 2-9

B

battle(s), 2-5, 2-6, 2-10, 2-12, 2-14, 2-30, 5-73, 5-74, 7-6

campaign objective and, 2-14

decisive operations and, 4-84, 7-22

exploitation of, 2-7

operational maneuver and, 4-5

battle command, 5-1–5-74

communications and, 5-3, 5-69

decisions and 5-4

defensive execution and, 8-65

defensive planning and, 8-57

leadership and, 5-1, 5-6

operations process and, 6-1

signal support and, 5-69

battlefield organization, 4-83–4-99. *See also* close area; decisive operations; deep area; main effort; rear area; shaping operations; sustaining operations

battlespace, 4-51, 4-77–4-82, 8-34, 11-77, 12-14

commander's vision and, 5-10, 5-11

CSS preparation and, 12-15

extension of, 12-46

home station and, 4-81

information environment and, 4-80, 11-8

information systems and, 11-4

media and, 5-21

monitoring, 6-36

perspectives and, 5-57

power projection platform and, 4-82

visualization of, 7-78

BOS, 4-65, 5-1, 5-9, 5-42, 5-61, 5-64–5-72, 6-59, page 5-14

boundaries, 4-75, 7-7, 7-93, 8-60

branches, 4-94, 6-18, 6-19, 8-68

C

C2, 5-71–5-72, 7-108, 8-76

anticipation and, 3-19

battle command and, 5-1

BOS and, 5-71–5-72

commander and, 4-51, 5-73–5-74

communications and, 5-71–5-72

concentration and, 7-14

concept of logistic support and, 12-14

coordination and, 11-74

COP and, 11-43

CSS and, 12-62

defensive execution and, 8-66

defensive IO and, 1-38

defensive planning and, 8-51

force allocation and, 3-31

force tailoring and, 3-13

forcible entry and, 3-54

foundation (attributes) of strategic responsiveness, 3-6

home station and, 4-82

information systems and, 11-31, 11-43

information environment and, 4-82, 11-8

initiative and, 4-51–4-52

lines of operations and, 5-34

METT-TC and, 11-4

multinational operations and, 2-45–2-50

operational reach and, 12-50

rear area operations and, 4-99

simultaneity and, 5-45, 5-49

strategic responsiveness consideration, 3-21–3-25

sustainability and, 12-5

- C2 (*continued*)
 technology and, 1-39, 11-86
 tempo and, 7-19
- campaign, 2-12, 2-30, 7-3, 7-22
 ASCC, role in, 2-36
 center of gravity and, 5-28
 defensive operations and, 8-3
 end state and, 5-25, 5-26
 example of, page 5-13
 operational maneuver and, 4-5
 planning and, 6-8–6-10
 sequential operations and, 5-47
 support relationships and, 2-17
 tactical results, influence of on, 2-8
- CBRNE,
 casualties, 10-22
 crisis management and, 10-26
 domestic preparedness for, 10-17–10-18
 protection of critical assets, 10-19
 response to incidents, 10-20
 support operations and, 10-12, 10-16–10-23
- CCIR, 6-5, 6-36, 11-39–11-41, 11-74, 11-76
- center of gravity, 5-27–5-29, 6-35
 decisive points and, 5-30
 defensive planning and, 8-47
 enemy and, 5-27
 friendly and, 5-29
 maneuver and, 6-52, 6-34, 6-79
 offensive operations and, 7-4
 operational approaches and, 5-28, 5-40
 sequential operations and, 5-44
 support operations and, 10-2
- civil considerations
 defensive planning and, 8-60
- METT-TC, factor of, 5-12, 5-18–5-22
 offensive planning and, 7-93–7-94
 stability operations and, 9-15
 support operations and, 10-43
- civil disturbances, 10-29
- civilian population. *See* local population
- close air support, 2-20, 2-72
- close area, 4-95–4-97
- close combat, 2-13, 4-9, 4-10, 4-15, 4-96, 7-22
- CMO, 9-49
 activities, 2-60
 FID and, 9-26
 IO and, 11-49, 11-68, 11-70
 local population and, 6-73
 NGOs and, 2-61
- CMOC, 9-49, 10-41
- coalition, 2-43, 5-29, 5-52
- Coast Guard, 2-24
- COCOM, 2-2, 2-28, 2-30, 2-31
- combatant commander, 1-490, 2-1, 2-2, 2-15, 2-18, 2-25, 2-30, 2-36, 5-29, 6-8, 11-20
 ASCC and, 2-36, 2-37
 command relationships and, 2-29, 2-30–2-34, 2, 4-45
 CSS and, 2-47, 12-9, 12-37–12-38, 12-41
 force tailoring and, 2-28, 3-2, 3-27
 multinational support and, 12-32
 operational framework and, 4-74–4-75
 PME and, 1-11, 9-2, 9-4, 9-5, 9-7
 response to crises, 9-8, 9-45
- combat zone, 4-69, 4-72
- combatting terrorism, 9-37–9-39, 10-6
- combined arms, 2-16, 4-102–4-108, 5-68
- command, 5-2–5-6
- command and support relationships, 2-30–2-34,
 command post, 5-72, 11-24, 11-34, 11-63, 11-83
- commander. *See also* leader
 agility and, 3-12
 area of influence and, 4-79
 area of interest and, 4-79
 audacity and, 7-20
 BOS and, 5-1, 5-64
 C2 system and, 5-71, 7-107
 combat power and, 3-14, 4-2
 combined arms capability and, 4-102, 4-104
 communication with superiors, 2-8
 community assistance and, 10-38
 considerations at the operational level, 2-11
 cooperation with nonmilitary groups, 9-48–9-49
 CSS capabilities and, 3-34
 decision making and, 3-20, 3-21, 5-4
 decisive operations and, 7-23
 deployment, preparation for, 3-11
 depth and, 4-61
 describing operational framework, 5-60
 describing vision and, 5-6
 direction by, 5-6
 elements of combat power and, 4-3
 force sequencing and, 3-33
 force tailoring and, 3-30
 fratricide avoidance and, 4-27
 information environment and, 4-80
 information superiority and, 11-1, 11-2, 11-6
 information technology and, 11-83–11-86
 initiative and, 4-51
 initiative in support operations and, 4-57

- commander (*continued*)
- leadership and, 4-16, 5-3
 - location of, 5-73, 8-64
 - main effort and, 4-93
 - maintaining focus and, 6-42
 - massing effects and, 4-39–4-41
 - media and, 1-31
 - momentum and, 6-41
 - objective and, 4-35
 - operational art and, 2-6
 - operational fires and, 4-13
 - operational framework and, 4-2, 4-69
 - operational responsibilities, 2-7, 2-10, 5-40
 - plans and, 2-9, 3-20
 - political factors and, 1-30–1-31, 4-35
 - pressuring the enemy and, 6-44
 - rehearsals and, 3-36
 - reserves and, 4-89, 7-24
 - responsibilities regarding political factors, 1-31
 - relevant information and, 3-45
 - ROE limitations and, 6-28
 - simplicity and, 4-48
 - situational understanding and, 4-28
 - support to civil authorities and, 12-34
 - synergy and, 4-108
 - tactical responsibilities, 2-10
 - task organization and, 4-101
 - training and, 1-51–1-52, 3-36
 - unified action and, 4-100
 - visualization and, 3-25, 5-6
- commander's intent, 4-30, 5-61–5-62, 5-68, 6-2, 7-7, 12-14
- agility and, 4-58
 - assessment and, 6-90
 - center of gravity and, 5-28
 - concept of operations and, 6-19
 - C2 system and, 5-71
 - CSS and, 12-11, 12-36
 - describe, as part of, 5-6, 5-60
 - exploitation of success and, 6-30, 6-46, 6-47
 - information technology and, 11-81
 - initiative and, 4-51–4-52, 6-6, 6-31
 - integration and, 12-6
 - massing of fires and, 4-15
 - MRXs and, 3-36
 - multinational operations in, 2-56
 - reconstitution and, 6-84
 - rehearsals and, 7-96
 - subordinate initiative and, 4-18, 6-36, 11-76
- commander's vision, 5-4. *See also* visualization
- development of, 5-10–5-12
 - end state and, 6-3
 - MRXs and, 3-37
 - public opinion and, 5-22
- communications, C2 and, 5-72
- civilian agencies and, 3-23
 - commander's requirements for, 3-23
 - decisive points and, 5-31
 - nonlinear operations and, 7-28
 - split-based operations and, 3-34
- community assistance, 10-32–10-38
- COMMZ, 4-70, 4-73
- concentration, 7-8, 7-14–7-16, 8-72
- concept of logistic support, 12-3, 12-6, 12-9, 12-14
- CSS priorities and, 12-11
 - defensive operations and, 12-30, 12-31
 - offensive operations and, 12-28
- concept of operations, 6-9, 6-19, 12-9
- battlefield organization and, 4-83
 - battlespace and, 4-78
 - commander's intent and, 6-19
 - concept of logistic support and, 12-14
 - direct, as part of, 5-64
 - CSS assets and, 12-12
 - decisive and shaping operations, 4-86
 - defensive operations and, 8-46
 - in multinational operations, 2-52
 - initiative and, 4-51
 - integration and, 12-6
 - mission and, 8-49
 - noncontiguous AOs and, 4-76
 - offensive planning and, 7-80
 - reserves and, 8-38
 - simplicity and, 4-48
 - synchronization of BOS and, 6-19
 - tactical CSS and, 12-36
- conflict termination, 6-87–6-89
- contiguous AO, combinations with noncontiguous AOs, linear and nonlinear operations, 5-49, 5-53, 6-60–6-64
- CSS and, 12-25
 - linear operations and, 5-51
 - nonlinear operations and, 5-45
 - spatial categories and, 4-83
 - subordinate unit AOs and, 4-76
- contractor support, 3-34, 5-16, 12-8, 12-15, 2-16, 12-25, 12-55
- stability operations and, 12-33
 - sustainability and, 3-17
 - tactical CSS and, 12-36
- control measures, 6-21
- AO and, 4-75
 - IPB and, 8-51
 - mission assignment and, 7-82
 - tactical-level, 7-7
- COP, 3-21, 4-29, 7-100, 11-43, 11-71, 11-78, 12-2

<p>COP (<i>continued</i>)</p> <ul style="list-style-type: none"> commander's impact and, 5-73 CSS and, 12-10, 12-58 information processing and, 11-29 information technology and, 7-106 IPB and, 11-18 offensive operations and, 7-8 situational understanding and, 11-44 subordinate initiative and, 11-46, 11-80 technology and, 11-45, 11-83 updates of, 6-39 visualization and, 5-57, 6-37 <p>counterair, 2-20</p> <p>counterattack, 7-59, 7-61, 8-7, 8-64</p> <ul style="list-style-type: none"> area defense and, 8-15, 8-20 culminating point and, 5-38 defensive execution and, 8-66, 8-73–8-74 defensive planning and, 8-14, 8-18 defensive preparation and, delay and, 8-30 mobile defense and, 8-17, 8-36 <p>counterdrug operations, 9-35–9-36, 10-6, 10-27–10-28, 10-30</p> <p>counterinsurgency, 9-27–9-31, 9-52</p> <p>countermobility, 5-66, 7-97, 8-39, 8-60</p> <p>counteroffensive, 6-18, 8-48</p> <p>counterterrorism, 9-37, 9-38, 10-25–10-26</p> <p>course of action, 7-79</p> <ul style="list-style-type: none"> branches and, 6-17 commander's intent and, 5-62 concept of logistic support and, 12-14 concept of operations and, 6-19 defensive planning and, 8-51 	<ul style="list-style-type: none"> reconstitution planning and, 6-85 risk management and, 6-20 <p>covering force, 7-48</p> <p>crisis, 1-12–1-13, 3-3, 3-9, 3-48</p> <p>CS, 5-16, 8-71, 12-48, 12-58</p> <ul style="list-style-type: none"> force projection base and, 4-81 force tailoring and, 3-13, 3-38, 3-29 home station and, 4-82 stability operations and, 3-30 support operations and, 3-30 sustainability and, 12-14, 12-48 sustaining operations and, 8-43 <p>CSS, 1-39, 2-13, 4-90, 12-1–12-63</p> <p>art of, 12-3</p> <p>ASCC commander responsibilities and, 2-36</p> <p>assisted entry, 3-49</p> <p>BOS, 5-70, 12-1</p> <p>characteristics of, 12-6</p> <p>combat power and, 12-1, 3-34, 3-33</p> <p>defensive operations and, 8-51, 8-71, 12-30–12-31</p> <p>depth and, 4-64</p> <p>exploitation and, 6-48, 7-73</p> <p>factors affecting, page 3-11</p> <ul style="list-style-type: none"> force projection base and, 4-81 force tailoring and, 3-13, 3-17, 3-29 functions, 12-7 home station and, 4-82 joint operations and, 12-37–12-44 modular, 3-35, 12-4, 12-41, 12-47, 12-50, 12-62, 12-63 multinational operations and, 2-44, 2-54, 12-19–12-22 national-level, 12-45 national sustainment base support for, 12-40 	<ul style="list-style-type: none"> nonlinear operations and, 5-49 offensive operations and, 7-90, 12-27–12-29 operational-level, 7-97, 12-40 planning, 12-2, 12-6, 12-9–12-14, 12-36, 12-42 preparation, 12-9–12-23 purpose of, 12-1–12-5 reorganization and, 6-49 requirements, 12-3, 12-6, 12-10, 12-12, 12-13, 12-15, 12-23, 12-26, 12-28 risk analysis and, 12-57 split-based, 3-22, 3-34, 12-4, 12-56 stability operations and, 3-30, 12-29, 12-32–12-33 strategic-level, 12-37, 12-41, 12-45 strategic responsiveness and, 3-33–3-34 simultaneous operations and, 5-50 support operations and, 3-30, 12-34–12-35 supported forces and, 7-27 sustainability and, 1-20, 3-17 sustaining operations and, 8-43 tactical-level, 12-30, 12-36, 12-40, 12-44 technology and, 7-108, 12-62–12-63 theater infrastructure, 12-16–12-17 unassisted entry and, 3-49 urban operations and, 6-77–6-78 withdrawal and, 8-26, 8-27 <p>CSS commander, 12-2, 12-4, 12-9, 12-11, 12-14, 12-15, 12-30, 12-31, 12-35, 12-48, 12-50</p> <p>CSS footprint, 3-4, 3-17, 12-4, 12-62</p> <p>CSS reach, 3-4, 12-4, 12-13, 12-46, 12-48, 12-52, 12-56, 12-57, 12-58, 12-62</p>
--	---	--

CUL, 2-36–2-37, 12-41, 12-42, 12-43

culminating point, 5-23, 5-38–5-39, 7-2, 8-75

D

deception. *See* military deception

decision making, 8-74, 11-39, 11-86

art of command and, 5-3

battle command, 5-3—5-5

battlefield organization and, 4-83

execution and, 7-98

information and, 1-38, 5-4, 11-6, 11-39,

information superiority and, 11-3

initiative and, 4-53

risk management and, 6-20

technology and, 1-39

tempo and, 7-18

tools for, 5-71

understanding and, 11-28

decisive operations, 3-4, 4-54, 4-66, 4-83, 4-84–4-85, 6-51, 6-78

branches and sequels and, 4-94

close area and, 4-96, 4-97

conflict termination and, 6-87

counterattack as, 7-61

CSS and, 12-1, 12-5

defensive operations and, 8-12, 8-36–8-38, 8-75

demonstrations and, 7-66

economy of force and, 4-42

exploitation and, 7-72

feints and, 7-65

main effort and, 4-94

mobile defense and, 8-17

offensive operations and, 7-8, 7-22–7-24, 7-79

reserve and, 4-89

shaping operations and, 4-86, 7-25

sustaining operations and, 4-90

terrain and, 7-85

decisive point, 5-23, 5-24, 5-30–5-33, 6-34, 11-50, 11-83

concentration and, 7-16

defensive operations and, 8-11, 8-37

defensive planning and, 8-47

maneuver and, 6-52

nonlinear operations and, 5-45, 5-46

offensive operations and, 7-4

operational approach and, 5-42

simultaneous operations and, 5-42

types of, 5-31

deep area, 4-83, 4-95, 4-98

defensive IO, 7-25, 11-53, 11-55. *See also* IO

element of force protection, as 4-22

EEFI and, 11-42

information superiority and, 1-38

defensive operations, 8-8–8-14, 8-34–8-45, 8-46–8-73. *See also* area defense; mobile defense; retrograde

close combat and, 4-10

CSS and, 12-30–12-31

culminating point and, 5-38

decisive operations in, 4-85

depth and, 4-61–4-62

encircled force, 8-69–8-70

execution and, 8-65–8-75

force projection and, 8-4

hasty attacks and, 7-54

initiative and, 4-55

nonlinear operations and, 8-44–8-45

operational-level, 8-3, 8-46

planning, 8-47–8-61

preparation for, 8-62–8-64

purpose of, 8-1–8-7

spectrum of conflict and, 1-48

sustaining operations, 8-41–8-43

technology and, 8-6, 8-74

types of, 8-14–8-33

delay, 8-28–8-31

defensive planning and, 8-59

deliberate attack, 7-56, 7-82

demonstration, 7-11, 7-38, 7-59, 7-65

deployment, 3-11, 3-19, 3-21, 3-22, 3-55. *See also* forward deployment

Coast Guard contributions to, 2-24

components of, 3-39

CSS, decisive operation, as, 4-85

flexibility and, 3-20

force projection process, as part of, 3-39

force tailoring and, 3-27

information sharing and, 1-38

information superiority and, 11-75

operational art and, 2-5

precision and, 3-41

preventive diplomacy and, 9-23

readiness and, 3-9

responsiveness and, 3-9

speed of, 3-25

stability operations and, 9-9

deployment sequence, 3-32

depth, 4-61–4-64

offensive operations and, 12-29

simultaneous operations and, 5-45

sustainment and, 6-59

deterrence, 1-2, 9-8

Army role in, 1-2

lethality of deploying force and, 3-26

deterrence (*continued*)
 show of force and, 9-45, 9-55
 stability operations and, 9-10–9-11
 strategic responsiveness and, 3-5
 doctrine, 1-44–1-46, 4-1
 adversary, 1-28
 after-action reports and, 6-94
 asymmetric attacks and, 4-114
 precision and, 3-41
 unified action and, 1-44, 2-72
 DSO, 10-3, 10-4–10-6, 10-11, 10-41
 DTLOMS, 1-5, 4-43, 6-94, 11-3

E

economy of force, 4-42, 4-86, 8-17
 EEFI, 11-38
 elements of combat power, 4-3, 4-4–4-31, 4-86, 8-7, page 3-4
 enabling system, 5-30
 encirclement, 5-35, 7-30, 7-34, 7-76
 end state, 5-23, 5-24, 5-25–5-26, 11-8
 battle command and, 5-3
 commander's impact and, 5-74
 commander's intent and, 5-58, 5-61–5-62
 commander's vision and, 6-3
 conflict termination and, 6-88
 consensus building and, 2-77
 encirclement and, 7-34
 multiple lines of operations and, 5-37
 phasing and, 6-14
 stability operations and, 9-12
 enemy, defensive planning and, 8-50–8-52
 METT-TC, factor of, 5-15, 7-83
 offensive planning and, 7-83
 stability operations and, 9-13

support operations and, 10-2
 engagement, 2-5, 2-7, 2-8, 2-10, 2-12–2-14, 5-41
 security environment, 1-7, 9-4
 tactics and, 2-12, 2-14,
 entry operations, 3-48–3-54,
 page 3-4
 envelopment, 7-23, 7-30–7-33,
 7-37, 7-76
 estimates, 3-46, 5-57, 6-12
 METT-TC and, 5-13
 staff preparation and, 6-23
 visualization and, 5-9, 5-10
 EW, 4-66, 11-61, 11-63, 11-64
 exploitation, 6-19, 6-44, 6-45,
 7-41, 7-42, 7-62, 7-67–7-74,
 7-103

F-G

Federal Response Plan, 10-4, 10-21
 feint, 7-11, 7-38, 7-57, 7-59, 7-65
 FFIR, 11-40, page 11-13
 FHA, 10-3, 10-7–10-13, 10-42
 FID, 1-19, 9-23, 9-24–9-31, 9-52
 field discipline, 4-21, 4-24–4-25.
See also protection
 fire support, 5-67, 6-58
 counterattack and, 8-18
 forcible entry and, 3-54
 maneuver and, 4-12
 fire support coordination, unified
 action considerations, 2-66–2-73
 firepower, 4-11–4-15, 5-68, 7-102. *See also* elements of
 combat power
 defensive planning and, 8-57
 maneuver and, 4-11, 4-42
 fires, 2-13, 4-10, 4-13, 5-67, 8-74
 Air Force, 2-19
 ambushes and, 7-64
 attacks and, 7-53

defensive operations and, 8-13
 deliberate attacks and, 7-56, 7-57
 encirclement and, 7-34
 envelopment and, 7-31
 fixing the enemy and, 7-101
 forward passage of lines and, 7-105
 frontal attack and, 7-40
 indirect, 2-56, 7-108
 lethal, 6-58
 maneuver and, 2-70, 6-56–6-57, 7-102
 meeting engagement and, 7-51–7-52
 penetration and, 7-37
 precision, 5-50, 7-14, 7-101, 7-107, 8-57
 pursuit and, 7-75
 shaping operations and, 6-56
 tactical, 4-12, 4-15
 technology and, 7-108
 flexibility, 8-13, 11-23, 11-24, 12-6, 12-50, 12-55, 12-57
 follow-on force, 3-3, 7-104
 deliberate attacks and, 7-58
 exploitation and, 7-103
 force tailoring and, 3-27
 forcible entry and, 3-53
 information sharing with
 initial-entry force, 1-38
 lessons learned and, 3-37
 lethality and, 3-14
 penetration and, 7-38
 follow-on operations, 6-79–6-86
 force allocation, 2-28, 3-31
 force augmentation, 3-31
 force projection, 3-38–3-54, 6-35
 characteristics of, 3-40–3-45
 Coast Guard role in, 2-24
 CSS and, 3-34, 12-14, 12-43
 decision making and, 3-21
 defensive operations and, 8-4
 engagement and, 1-7

- force projection (*continued*)
- entry operations, 3-48–3-54
 - force tracking and, 3-24
 - JOPES and, 3-46
 - modernization effects on capabilities, 3-4
 - multinational operations and, 2-42
 - power projection component, 3-38
 - processes, 3-39
 - purpose of, 3-40
 - responsiveness and, 3-8
 - security of, 3-55
 - strategic responsiveness and, 3-1
 - sustaining operations and, 8-43
 - threats to, 3-55
 - throughput and, 12-62
 - visualization of, 3-25
- force protection, 4-21, 4-21–4-23, 4-114, 6-35, 6-58. *See also* protection
- defensive operations and, 8-10
 - information superiority and, 9-21
 - intelligence support to, 5-62, 5-65
 - offensive operations and, 7-8
 - survivability and, 3-15–3-16
 - technology and, 1-39
 - WMD and, 6-71
- force refinement, 3-32
- force sequencing, 3-7, 3-32
- COP and, 3-21
 - crises and, 3-48
 - force refinement and, 3-32
 - lethality and, 3-14
 - operational reach and, 3-14
 - strategic responsiveness and, 3-2
 - versatility and, 3-13
- force tailoring, 1-41, 3-27–3-29, 7-5
- ASCC commander and, 2-36
- assisted entry, 3-49
 - civil authorities, support to, 1-21
 - IR and, 11-68
 - METT-TC and, 3-47, 11-75
 - operational environment and, 1-24
 - strategic responsiveness and, 1-15, 3-5, 3-27–3-29
 - support to JFC, 4-101
 - sustainability and, 3-17
 - theater conditions and, 3-2
 - transition and, 6-80
 - versatility and, 3-13
- force tracking, 3-24, 3-34
- forcible entry, 1-16, 3-51–3-54
- force tailoring and, 3-29
 - Marine Corps and, 2-23
 - modernized forces and, 3-4
- forward basing, 1-10, 9-10
- forward deployment, 3-8, 12-4, 9-10. *See also* deployment; deterrence
- forward presence, engagement and, 1-7. *See also* deterrence
- fratricide, 2-72, 4-21, 4-27, 7-29, 7-73. *See also* protection
- frontal attack, form of maneuver, 7-23, 7-39–7-40
- FSCL, 2-71
- FSCM, multinational operations and, 2-56, 2-71
- full spectrum operations, 1-4, 1-6, 1-44, 1-47–1-48, 2-1, 3-13, 12-46
- Army force development responsibilities, 1-22
 - complex environments and, 6-65–6-78
 - CSS and, 12-62
 - demands on leaders, 1-57
 - fundamentals of, 4-1
 - IM and, 11-48
 - IR and, 11-35
 - METT-TC and, 5-12
- operations process and, 6-1
- protection and, 4-20
 - rehearsals and, 6-22
 - tenets of Army operations and, 4-2
 - training for, 1-51–1-52
 - unified action and, 2-1
- H-I**
- hasty defense, 7-34
- HCA, 2-42, 4-84, 9-33
- home station, 3-21, 4-82, 12-54
- communications and, 3-23
 - force projection and, 3-37, 4-81
 - redeployment and, 3-39
- host nation support, 12-19, 12-21, 12-32, 12-57
- CSS and, 12-15, 12-50
 - mission analysis and, 3-29
 - movement control and, 4-90
 - sustainability and, 3-17
- IM, 11-11, 11-12, 11-28–11-44
- coordination and, 11-67
 - deliberate attacks and, 7-58
 - full spectrum operations and, 11-48
 - information superiority and, 1-38
 - planning and, 11-71, 11-73
- infiltration, 7-35
- information, 4-28–4-31, 5-5, 5-7, 8-74. *See also* elements of combat power
- attacks and, 7-100
 - battle command and, 5-3–5-5, 5-7, 5-9
 - categories of, 11-35
 - civil considerations and, 5-21
 - commander's requirements for, 11-30
 - culmination and, 5-38
 - decision making and, 5-5
 - defense and, 4-55, 8-52
 - force protection and, 4-21

- information (*continued*)
- fusing of, 7-108
 - linear operations and, 5-52
 - maneuver and, 4-43
 - offensive operations and, 7-2
 - operational environment and, 1-38–1-39
 - parallel planning and, 6-11
 - protection of, 4-23
 - quality of, 11-38
 - search and attack and, 7-50
 - simultaneous operations and, 5-46
 - spoiling attacks and, 7-60
 - unconventional threats and, 6-75
- information environment, 1-37, 4-80, 11-8–11-10
- battlespace and, 4-77, 4-80
 - civil considerations and, 7-94
 - time available and, 7-92
- information superiority, 1-38, 11-1, 11-11–11-70
- characteristics of, 11-3–11-7
 - conditions for achievement of, 11-4
 - creation of, 6-58
 - decision making and, 1-38
 - defensive IO and, 1-38
 - defensive planning and, 8-48
 - execution of, 11-78–11-81
 - implications of, 11-5
 - objectives contributing to, 11-11
 - offensive IO and, 1-38
 - operational advantage of, 11-1
 - PKO and, 9-21
 - planning and, 11-61, 11-73
 - preparation and, 11-71, 11-73
 - simultaneous operations and, 5-43, 6-51
 - surprise and, 4-47
 - technology and, 11-82–11-86
- information systems, 11-10, 11-16, 11-31, 11-73, 11-80, 12-60. *See also* C2
- battlespace and, 11-4
- component of IM, 11-28
 - decision making and, 4-29
 - information superiority and, 11-2, 11-3
 - modernization of, 4-31
 - time available and, 7-92
- infrastructure development, 4-90
- initial-entry force, 2-19, 3-3
- crisis response and, 3-49, 3-50
 - defensive operations and, 8-4
 - deployment requirements and, 3-27
 - forcible entry and, 3-53
 - information sharing with follow-on forces and, 1-38
 - interim force and, 3-4
 - lethality and, 3-14
 - protection of, 3-32
 - shaping operations and, 3-26
 - stability operations and, 3-48
 - support operations and, 3-48
- initiative, 1-4, 1-45, 4-51–4-57, 4-108, 6-31, 7-108, 11-46, 11-80
- battle command and, 5-5
 - CCIR and, 6-36
 - commander's intent and, 6-6
 - CSS and, 12-1
 - defensive operations and, 8-4, 8-7, 8-73
 - enemy seizure and retention of, 6-31–6-32
 - exploitation and, 4-60, 7-2, 7-67
 - information superiority and, 11-5, 11-6
 - leader, 1-54
 - meeting engagement and, 7-52
 - mobile defense and, 8-16
 - momentum and, 6-40–6-41
 - nonlinear operations and, 5-49
 - offensive operations and, 7-8
 - operational, 2-9
- operational pause and, 5-43
- plans and, 6-3, 6-6
- reconstitution and retention of, 6-86
- regaining the, 1-48, 3-5
- retaining the, 1-38, 4-54, 4-60, 4-90, 6-19, 6-30, 6-31–6-39, 6-51, 7-2, 7-92, 11-5
- retrograde and, 8-22
- ROE and, 6-27
- seizing of, 1-15, 3-5, 3-26, 3-43, 3-52, 4-60, 4-89, 6-6, 6-30, 6-31–6-39, 6-51, 7-2, 7-4, 7-20, 7-62, 7-100, 8-73, 11-86
- situational understanding and, 11-46
- subordinates, 1-38, 1-54, 3-11, 11-80–11-81
- synchronization and, 4-65
- technology and, 7-106
- tempo and, 5-54–5-55, 7-17
- uncertainty and, 6-33
- instruments of national power, 5-19, 5-25, page 1-4
- interagency process and, 2-59
 - logical lines of operations, 5-37
 - military, 1-9, 2-59
- insurgencies, support to, 9-34
- intelligence, 11-13–11-18, page 11-7. *See also* ISR
- area of interest and, 4-79
 - BOS, 3-19, 5-65
 - deliberate attacks and, 7-56
 - deployment and, 3-11
 - information superiority and, 11-1
 - meeting engagements and, 7-51
 - multinational operations in, 2-57
 - offensive operations and, 7-8
 - raids and, 7-63
 - readiness and, 3-19
 - rear area and base security component, 4-90

- intelligence (*continued*)
 role of, 6-57
 tasks, 5-65
- interagency operations, 1-35, 2-59–2-64
 information technology and, 2-63, 3-32, 11-84,
 interagency process, 2-59–2-64
- interdiction, 2-70, 7-25, page 2-20
 Army support to Air Force, 2-20
 multinational operations and, 2-56
 operational fires and, 4-13
 synchronization with maneuver and fires, 2-17, 2-69–2-72
- internal defense and development, 9-5, 9-29
- interoperability, 2-37, 2-45, 2-77, 2-83
- IO, 7-101, 7-107, 11-1, 11-10, 11-49–11-70, 11-72, page 11-15. *See also* defensive IO; offensive IO
 area of interest and, 4-79
 ARSOF capability, 1-20
 defensive operations and, 8-5, 8-10, 8-39, 8-64
 deliberate attacks and, 7-58
 elements of, 11-56–11-70, page 11-17
 information environment and, 11-8
 information superiority and, 1-38
 multinational operations and, 2-56
 intelligence and, 11-12
 noncontiguous AOs and, 11-74
 stability operations and, 4-63
 surprise and, 7-8
 value of, 11-50
 withdrawal and, 8-26
- IPB, 5-65, 11-15, 11-18, 11-52, 11-77, page 11-7
- asymmetric threats and, 1-40
 CSS and, 3-34
 defensive planning and, 8-51
 IO and, 11-45
 staff preparation and, 6-23
 urban operations and, 6-77
- ISB, 3-56–3-59, 12-50, 12-56, 12-59
 CSS reach and, 12-4, 12-5
 force projection and, 3-34, 3-60, 4-80
- ISR, 7-108, 8-76, 11-11, 11-13–11-27, 11-70
 advantages of, 11-13–11-14
 adversary use of, 1-29
 Air Force contribution to, 2-19
 assessment of, 11-15
 COP and, 4-29
 deliberate attacks and, 7-58
 information superiority and, 1-38
 management of, 11-16
 noncontiguous AOs and, 11-74
 offensive preparation and, planning and, 11-72
 preparation and, 7-96, 11-73
 relevant information and, 11-32
 security and, 4-46
 situational understanding and, 7-107
 stability operations and, 4-63
 strategic responsiveness and, 3-6, 11-75
- J-K**
- JFC(s), 1-33, 2-27, 2-36
 air and missile defense and, 2-70
 AO and, 4-74
 ARFOR, C2 options and, 2-37
 Army forces and, 1-4, 1-12
 Army METL and, 1-5
 assessment and, 1-31
- definition of readiness and, 3-24
 Coast Guard, support from, 2-24
 control measure development and, 2-71
 CSS planning and preparation and, 12-9
 designation of JFLCC and, 2-38
 end state and, 5-26
 fire support coordination and, 2-68–2-72
 force refinement and, 3-32
 force tracking and, 3-24
 forcible entry and, 1-16, 3-51, 3-52
 FSCM development, 2-71
 information planning and, 11-65
 ISB and, 3-56, 3-58
 joint targeting process and, 2-63
 JOPES and, 3-46, 3-47
 operational art and, 2-6
 operational framework and, 4-70
 multinational operations and, 2-50
 interagency process and, 2-60
 joint operations and, 2-16–2-17
 seizing of initiative and, 3-27
 spectrum of conflict and, 1-47
 strategic responsiveness and, 1-15, 3-5
 theater-level, 2-30
 transition and, 6-81
 unassisted entry and, 3-50
 unified action and, 1-32, 2-2, 4-106
- JFLCC, 2-23, 2-40,
 joint operations, 2-16–2-17. *See also* unified action
 Army CSS and, 12-37–12-44
 Army role in, 1-1
 ARSOF and, 1-20

joint operations (*continued*)
 CSS responsibilities and, 12-41
 forcible entry in, 1-16
 integration and, 12-6
 strategic responsiveness in, 1-12–1-13
 Joint Staff, role in interagency process, 2-60
 judgment, 1-54, 5-1, 5-3, 5-4, 5-5, 5-9, 7-78, 11-77
 commander's experience and, 5-58–5-59
 commander's vision and, 5-10
 information and, 11-31

L

law enforcement, unified action and, 2-82
 lead nation command, 2-51
 leader. *See also* commander
 command authority and, 5-2
 duty of, 4-17
 full spectrum operations, demands of, 1-57
 goals of a, 1-57
 initiative and, 4-52
 qualities of a, 4-18, 4-19
 skills required of a, 4-17
 stability operations and, 9-16
 leader development, 4-1
 leadership, 1-53–1-57, 4-16–4-18, 11-77. *See also* elements of combat power
 art of command and, 5-3
 battle command, 5-1, 5-5
 fratricide avoidance and, 4-27
 maneuver and, 4-43
 legitimacy, culminating point and, 5-39
 FID and, 9-27
 multinational operations and, 2-42
 objective and, 4-36
 PKO and, 9-21

stability operations and, 9-50–9-52
 lethality, 3-14, 3-15, 3-26
 levels of war, 2-3–2-14
 operational, 1-20, 1-21, 2-5–2-11, 5-19, 5-25
 strategic, 2-4
 tactical, 5-19, 5-20, 5-25, 5-26
 liaison, 2-53, 2-54, 2-56, 2-84
 linear operations, 4-95, 5-48–5-53
 combinations with nonlinear operations and contiguous and noncontiguous AOs, 6-60–6-64
 nonlinear operation and, 5-48–5-53, 6-54–6-55
 spatial categories and, 4-83
 CSS and, 12-27
 lines of operation, 5-33–5-37, 5-49, 9-12
 LOC(s), 7-27, 12-14, 12-27, 12-58, 12-59
 COMMZ and, 4-73
 CSS and, 12-15, 12-29
 defensive operations and, 8-40, 8-41, 8-53
 exploitation and, 7-77
 information and, 7-108
 linear operations and, 5-51
 movement control and, 4-90
 multiple, 12-50, 12-52, 12-54
 Navy protection of, 2-22
 nonlinear operations and, 5-49
 operational reach and, 5-40, 12-50, 12-52
 pursuit and, 7-77
 retrograde and, 8-22
 security and support of, 12-50, 12-60
 split-based operations and, 12-56
 local population, counterinsurgencies and, 9-30
 defensive planning and, 8-60
 legitimacy and, 9-50

stability operations and, 9-54
 surveillance and, 11-51
 local security, 4-22
 lodgment, 3-26, 3-48,
 force projection and, 3-34
 forcible entry and, 3-51, 3-53
 sustaining operations and, 8-43
 logistic preparation of theater, 3-34
 logistics. *See* CSS

M

MACA, 10-6
 main effort, 4-93–4-94
 decisive operations and, 4-94
 defensive operations in, 8-13, 8-37, 8-68
 major operation, 2-5, 2-12, 2-30, 5-41, 7-3
 ASCC role in, 2-36
 CSS and, 12-38
 decisive operations and, 4-84, 7-22
 defensive operations and, 8-5
 elements of operational design and, 5-23–5-24
 planning and, 6-9
 support relationships and, 2-17
 sustaining operations and, 7-27
 maneuver, 1-12, 4-4–4-10, 4-43, 6-52–6-57. *See also* elements of combat power
 BOS, 5-66
 center of gravity and, 6-53
 example of, page 7-8
 firepower and, 4-11
 decisive points and, 6-52
 deliberate attacks and, 7-56
 fires and, 6-52–6-57, 7-102
 forms of, 7-33–7-41
 linear and nonlinear operations and, 5-49, 5-50, 5-51
 lines of operations and, 5-36

- maneuver (*continued*)
- massing effects and, 4-40
 - meeting engagement and, 7-52
 - operational approach and, 5-42
 - seizing initiative and, 6-54
 - strategic responsiveness and, 1-12
 - synchronization with fires and interdiction, 2-17, 2-70–2-71
 - tactical, 3-8, 4-7, 4-8, 4-27
 - terrain and, 7-84
- Marine Corps, 2-21, 2-23, 3-52
- mass, 4-29, 4-39–4-41, 7-4, 7-14, 7-107
- defensive operations and, 8-11–8-12, 8-37
 - IO and, 11-50
 - maneuver and, 6-56
 - offensive preparation and, 7-95
 - penetration and, 7-38
 - synchronization and, 4-3, 4-65
 - WMD and, 8-72
- measures of effectiveness, assessment and, 6-91
- consensus building and, 2-77
 - end state and, 5-26
 - support operations and, 10-43
- media, 5-21
- anticipation and, 3-20
 - commander and, 1-31
 - impact of, 11-9
 - legitimacy of military operations and, 1-37
 - public affairs and, 11-69
 - public opinion and, 1-37
 - stability operations and, 9-54
 - time available and, 7-92
 - unified actions and, 2-81
- meeting engagement, 7-51–7-52, 7-107
- METL, 1-5–1-23, 1-52, 3-9, 3-35
- METT-TC, 5-12–5-22, 8-34
- assessment and, 5-9
 - C2 and, 11-4
 - commander's vision and, 5-10, 5-12
 - defensive planning and, 8-48–8-61
 - force refinement and, 3-32
 - force tailoring and, 3-47
 - forms of maneuver and, 7-30
 - offensive planning and, 7-81–7-94
 - relevant information and, 11-32
 - simplicity and, 4-48
 - situational understanding and, 11-46
 - stability operations and, 9-12–9-15
 - visualization and, 5-9
- military deception, 6-35, 11-50
- concentration and, 7-15
 - counterattack and, 8-18
 - defensive operations and, 8-12, 8-64
 - mobile defense and, 8-18
 - offensive IO and, 4-30
 - security and, 4-45
 - survivability and, 5-69
- military decision making process, 6-12, 9-47, 10-39, 11-40
- mission analysis, 3-29, 5-10, 5-11, 12-10
- mission-type orders, 4-53, 6-21, 12-6
- mobile defense, 8-6, 8-15, 8-16, 8-17–8-19, 8-66, 8-67
- area defense and, 8-20
 - CSS and, 12-30, 12-31
 - decisive operations and, 8-36
 - nonlinear operations and, 5-45, 8-44
- mobility, 5-66, 8-39
- defensive planning and, 8-53
 - delay and, 8-31
 - forcible entry and, 3-52
 - movement to contact and, 7-47
 - offensive planning and, 7-88
 - reconnaissance assets and, 11-24
 - weather and, 7-84
- mobilization, 1-14, 1-15, 3-21, 3-39, 4-84
- modular operations, 12-4
- momentum, 6-41, 7-98, 7-99
- concentration and, 7-15
 - CSS and, 12-1
 - deliberate attacks and, 7-56
 - exploitation and, 7-77, 7-106
 - initiative and, 6-40–6-41
 - maintaining of, 6-40–6-49
 - meeting engagement and, 7-50
 - offensive planning and, 7-80
 - pursuit and, 7-77, 7-106
 - shaping operations and, 6-50
 - sustaining operations and, 7-27
 - tactical CSS and, 12-35
 - tempo and, 6-41, 7-19
- MOOTW, 1-30, 1-47, 1-52, 2-79
- morale, 4-25, 12-7, 12-30, 12-33
- CSS adjustments and, 12-55
 - defensive planning and, 8-57
 - home station and, 4-82
- movement, forms of, 7-45
- movement control, 4-90, 7-97, 8-41
- movement to contact, 7-45–7-52, 7-107
- MRX, 3-36
- MTW, 1-34
- stability operations and, 9-3
 - theater engagement and, page 9-1
- multinational force commander, creation of multinational staff, 2-52
- CSS preparation and, 12-20, 12-22
 - demands upon, 2-52, 2-57
 - host nation force missions, 2-58

multinational force commander
(*continued*)
 planning and, 2-56
 team building and, 2-75
 multinational forces, 1-20, 1-29,
 1-33, 1-39
 stability operations and, 9-14
 TACON and, 2-33
 multinational operations, 1-1,
 1-34, 1-41, 2-2, 9-19
 Army role in,
 C2 and, 2-48–2-54
 conduct of, 2-55–2-58
 CSS planning and, 12-20
 defensive planning and, 8-57
 integration and, 2-49–2-51,
 12-6
 lead nation and, 12-23
 mission assignments and,
 2-54
 national control of forces, 2-80
 role specialization and, 12-23
 simplicity and, 4-49
 spatial organization of AO,
 4-95
 unified action and, 2-1, 2-42–
 2-54
 multinational staff, 2-48

N

national military strategy, 1-7,
 1-30, 1-32
 national security strategy, 1-7,
 1-30, 2-18
 Navy, 2-21–2-22
 NBC, defense, 1-21, 4-21–4-23,
 4-113, 4-114
 munitions, disposal of, 12-7
 operations, 6-65–6-71
 reconstitution and, 6-85
 survivability and, 3-16, 5-66
 NCA, 1-15, 1-19, 9-8, 9-10, 9-20,
 9-34
 chain of command and, 2-29
 counterterrorism and, 9-38,
 10-25

end state and, 5-25
 instruments of national power
 and, 1-30
 mobilization and, 1-15
 relief operations and, 10-13
 SOF options for, 2-25
 strategic level and the, 2-4
 support agreements and,
 12-32
 theater of war and, 4-71
 WMD incidents, and response
 to, 10-20
 NEO, 9-40–9-42
 NGO, 2-2, 2-55, 9-15, 9-49
 CMO, role in, 2-61
 cooperation with Army forces,
 2-59
 CSS and, 12-33, 12-42, 12-50
 cultural considerations and,
 2-79
 religious support and, 12-7
 simplicity and, 4-49
 support operations and, 10-1
 noncontiguous AO
 combinations with contiguous
 AOs, linear and nonlinear op-
 erations, 6-60–6-64
 CSS and, 12-25
 defensive operations and,
 8-35
 information and, 7-108
 IO and, 11-74
 nonlinear operations and, 5-49
 stability operations and, 9-12
 subordinate unit AOs and,
 4-76
 support operations and, 10-2
 surveillance and, 7-26
 nonlethal weapons, 4-12
 nonlinear operations, 4-41, 4-95,
 5-49
 combinations with linear op-
 erations and contiguous and
 noncontiguous AOs, 5-49,
 6-60–6-64

defensive operations and,
 8-44–8-45
 element of operational design,
 5-49–5-53
 information and, 7-108
 linear operations and, 5-49,
 5-53, 6-54–6-55
 noncontiguous AOs and, 7-28
 stability operations and, 9-12
 encirclement and, 7-34
 offensive operations and, 7-28
 support operations and, 10-2

O

obstacles, 5-69, 12-18
 area defense and, 8-36
 defensive operations and, 8-8,
 8-12
 defensive planning and, 8-55
 encirclement and, 7-34
 mobile defense and, 8-16
 movement to contact and,
 7-48
 offensive planning and, 7-86
 terrain and, 7-84
 withdrawal and, 8-26
 offensive IO, 4-28, 6-58, 7-25,
 11-1, 11-49, 11-53, page
 11-16. *See also* IO
 defensive operations and, 8-9
 deliberate attacks, 7-57
 information superiority and,
 1-38
 targets of, 11-54
 withdrawal and, 8-26
 offensive operations, 1-48, 7-8–
 7-20, 7-78–7-108
 close combat and, 4-10
 CSS and, 12-27–12-29
 culminating point and, 5-38
 decisive operations in, 4-85
 depth and, 4-61–4-62
 initiative and, 4-54
 nonlinear operations and, 7-28
 operational framework and,
 7-21–7-29

- offensive operations (*continued*)
 operational-level, 7-3–7-5
 purpose of, 7-1–7-2
 shaping operations and, 7-25–7-26
 spectrum of conflict and, 1-48
 sustaining operations and, 7-27
 tactical-level, 7-3, 7-6–7-7
 types of, 7-42–7-77
- OPCON, 2-30, 2-32, 2-45
- operational approach, 5-42
- operational art, 2-5, 2-6, 2-6–2-11, 5-7–5-8, 5-30
- operational design, 2-9, 5-9
 branches and sequels in, 6-16
 commander's vision and, 5-2, 5-10
 CSS and, 12-31
 elements of, 5-23–5-56, page 5-5
 operational framework and, 5-58
 purpose of, 2-10, 5-23
 risk management and, 6-20
 ROE and, 6-29
- operational environment, 1-24–1-43
 dimensions of, page 1-7
 information factors and, 1-37–1-38
 land combat and, 1-36
 political factors and, 1-30–1-31
 technology and, 1-39–1-43
 threat factors and, 1-25–1-29
 unified action and, 1-32–1-35
- operational fires, 4-13–4-14
- operational framework, 4-2, 4-69–4-99, 5-56
 components of, 4-69
 CSS and, 12-6, 12-27
 defensive operations and, 8-34–8-45
 elements of operational design and, 5-60
- offensive operations and, 7-21–7-29
- operational maneuver/movement, 3-8, 4-5–4-6, 4-14
- operational pause, 5-40, 6-43, 12-14
- operational reach, 3-14, 5-24, 5-41, 12-3, 12-4, 12-12, 12-14, 12-52
 communications planning and, 5-72
 culmination and, 12-49
 extension of, 12-46–12-49
 factors affecting, 12-50–12-61
 force sequencing, 3-14
 operational approach and operational pauses and, 5-41–5-43
 simultaneous operations and, 6-51
 sustainment and, 6-59
 technology and, 1-39
- operations process, 6-1, 6-20
- OPSEC, 11-59
 asymmetric attacks and, 4-114
 force protection and, 4-23
 PSYOP and, 11-64
 stability operations, 9-56
 survivability and, 5-69
- P-Q**
- parallel command, 2-50
- parallel planning, 6-11–6-12, 12-10
- passage of lines, 7-25, 7-45, 7-103–7-105, 8-39
- penetration, 7-19, 7-37–7-39, 7-41, 8-69
- PEO, 9-19, 9-22
- phase(ing)(s), 2-17, 6-13–6-15
 campaign plan and, 6-9
 CSS and, 12-6, 12-10, 12-14
 decisive operations and, 7-22
 sequential operations and, 5-47
- simultaneous operations within, 6-14
 sustainability and, 12-6
 sustaining operations and, 7-97
 transition between, 6-15
- PIR, 11-17, 11-40
- PKO, 9-19, 9-21, 9-22
- plans/planning, 6-3–6-21
 anticipation and, 3-19, 3-20
 attacks and, 7-53
 audacity and, 7-20
 automated data and, 3-9, 3-46
 CCIR and, 6-5
 conflict termination and, 6-87
 counterattacks and, 8-18
 CSS, 12-9–12-14
 defensive operations and, 8-14 8-47–8-59
 deliberate attacks and, 7-56, 7-58
 deployment and, 3-11
 execution and, 6-7
 flexibility and, 2-9, 3-20
 force projection and, 3-44
 information technology and, 11-79
 main effort and, 4-94
 offensive operations and, 7-78–7-94
 operational design and, 6-8
 operational-level, 2-9, 2-10, 6-4, 6-9–6-11
 parallel, 6-12, 6-13, 8-60
 PO and, 9-20
 purpose of, 6-3, 6-7
 raids and, 7-63
 risk management and, 6-21
 ROE and, 6-29
 simplicity and, 4-48
 tactical-level, 6-4, 6-11
 urban operations and, 6-76
- PME, 1-4, 9-5–9-7
 Army forces and, 9-6
 responsiveness and, 3-8

- PME (*continued*)
 role of, 1-8–1-11
 spectrum of conflict and, 1-47
 stability operations and, 1-11
- PO, 9-19–9-23
- Posse Comitatus Act, 1-48, 10-5, 10-8, 10-11, 10-30
- power projection platform, 3-6, 4-81, 4-82
- preparation, 6-22–6-29
 anticipation and, 3-19
 attacks and, 7-53
 characteristic of defensive operations, 8-8
 CSS estimates and, 12-12
 defensive operations and, 8-62–8-64
 deliberate attacks and, 7-56
 hasty attacks and, 7-54
 individual, 6-26
 offensive operations and, 7-95–7-97
 operational-level, 7-95
 replacements and, 6-26
 ROE and, 6-28
 staff, 6-23
 unit, 6-24–6-25
- pre-positioned stocks, 9-10, 12-9, 12-12, 12-15, 12-16
 CSS reach and, 12-4, 12-47
 mission analysis and, 3-29
- principles of war, 4-2, 4-33–4-49, 4-50, 5-11
- propaganda, 9-27
- protection, 4-11, 4-20–4-23. *See also* elements of combat power
 air defense and, 5-65
 antiterrorism and, 9-39
 battlespace and, 4-77
 components of, 4-21
 concentration and, 7-15, 7-16
 culminating point and, 5-39
 defensive operations and, 8-40, 8-43, 8-57, 8-71
 maneuver and, 4-43
 offensive operations and, 7-80, 7-88, 7-95
 rear area, 4-99
 ROE and, 6-27
 search and attack and, 7-50
 shaping operations and, 7-25
 tactical maneuver and, 4-8
- PSYOP, 2-26, 11-64
 band support and, 12-7
 local population and, 6-73
 OPSEC and, 11-64
 public affairs, 6-72, 11-43, 11-68, 11-69, 12-7
 pursuit, 6-18, 7-42, 7-41, 7-62, 7-75–7-77
- R**
- raid, 7-59, 7-63
- RC, 1-23, 2-28, 4-100. *See also* ARNG
 DSO and, 10-11
 home station and, 4-81
 force projection operations and, 3-38
 mobilization and, 3-39
 power projection platform and, 4-82
 strategic responsiveness and, 3-1
- readiness, 3-9, 3-10, 3-19
- rear area, 4-99
- rear area and base security, 2-58, 4-90, 4-99, 8-41
- reconnaissance, 7-25, 11-22–11-27. *See also* ISR
 commander's, 8-54, 8-62
 defensive operations and, 8-8, 8-67
 deployment and, 3-11
 IPB and, 11-18, 11-72
 meeting engagement and, 7-51
 protection and, 6-35
 results of, 11-26
 retention of initiative and, 6-35
- surveillance and, 11-11, 11-13, 11-77
 tempo and, 7-99
 terrain and, 7-85
 WMD and, 6-72
- reconstitution, 6-83–6-86, 7-103, 12-14, 12-26
 CSS and, 12-14, 12-28
 defensive operations and, 8-12
 sustaining operations and, 4-90
- redeployment, 3-39
- refugees, 7-93
- regeneration, 6-83
- rehearsals, 3-36, 6-22
 commander's intent and, 7-96
 counterattacks and, 7-61
 defensive operations and, 8-8, 8-63
 linkup in nonlinear operations and, 7-29
 operational-level, 8-63
 preparation and, 11-66
 simplicity and, 12-6
 synchronization and, 4-66
 tactical-level, 8-63
 urban operations and, 6-78
 deliberate attacks and, 7-58
 deployment and, 3-11
- relevant information, 11-4, 11-71
 component of IM, 11-28, 11-32–11-34
 concentration and, 7-14
 COP and, 7-100
 counterattacks and, 8-74
 deployment and, 3-11
 initial-entry operations and, 3-26
 offensive operations and, 7-8
 situational understanding and, 11-34, 11-82
- relief operations, 10-12, 10-13–10-15
- reorganization, 6-25, 6-49, 6-84
- reserve, 5-6

- reserve (*continued*)
- area defense and, 8-20
 - close area and, 4-95
 - concept of operations and, 8-38
 - counterattacks and, 7-61
 - decisive operations and, 7-23
 - defensive operations and, 8-11, 8-13, 8-19, 8-38, 8-39, 8-59, 8-64
 - deliberate attacks and, 7-58
 - enemy penetration and, 8-68
 - mobile defense and, 8-19
 - nonlinear operations and, 7-28
 - operational reach and, 5-40
 - reorganization and, 6-49
 - shaping operations and, 7-25
 - striking force and, 8-19
 - uncertainty and, 7-24
 - withdrawal and, 8-25
- resource allocation, 2-2, 2-6, 2-11, 5-68
- responsiveness, 3-8–3-10, 12-6
- retirement, 8-32. *See also* retrograde
- retrograde, 8-14, 8-15, 8-22–8-33
- risk management, 6-20
- ROE, 1-36, 6-27–6-29, 6-74, 9-56, 9-59
- asymmetric attacks and, 4-114
 - defensive planning and, 8-59
 - PO and, 9-20
 - reconnaissance and, 11-23
 - urban operations and, 6-77
- RSO&I, 3-20, 3-22, 3-39, 3-48–3-50, 3-58, 12-16
- S**
- safety, 4-21, 4-26. *See also* protection
- search and attack, 6-64, 7-50
- security, 4-46, 7-103. *See also* security force; security operations
- as shaping operation, 4-88
 - asymmetric attacks and, 4-114
 - characteristic of defensive operations, 8-9
 - counterattack and, 8-18
 - defensive execution and, 8-65
 - defensive preparation and, 8-62
 - defensive sustaining operations and, 8-41, 8-42
 - surprise and, 4-47
 - withdrawal and, 8-26
- security assistance, 9-32
- security force. *See also* security; security operations
- area defense and, 8-20
 - defensive operations and, 8-8, 8-12, 8-40
 - movement to contact and, 7-46, 7-47
 - withdrawal and, 8-24–8-25
- security operations, 7-25, 7-26. *See also* security; security force
- sequels, 6-18, 6-80–6-83
- assessment and, 6-18
 - decisive operations and, 4-94
 - deliberate attacks and, 7-56
 - phasing and, 6-18
 - reserves and, 7-24
 - success and, 6-47
 - transition and, 6-83
- sequential operations, 1-36, 1-49
- CSS and, 12-27
 - decisive and shaping operations, 4-87
 - element of operational design, 5-44
 - massing effects and, 4-41
- shaping operations, 3-4, 4-83, 4-86–4-89, 6-50, 7-25
- close area and, 4-97
 - CSS and, 12-1
 - CSS reach and, 12-5
 - decisive operations and, 4-84, 7-25
 - deep area and, 4-98
 - defensive operations and, 8-39–8-40, 8-58, 8-67
 - deliberate attacks and, 7-56
 - fires and, 6-56
 - main effort and, 4-93
 - offensive operations and, 7-25–7-26, 7-95
 - strategic-level, 1-7–1-11
 - sustaining operations and, 4-90
- show of force, 9-45–9-46, page 9-12
- deterrence and, 9-55
 - preventive diplomacy and, 9-23
- simultaneous operations, 1-28, 1-36, 1-47, 1-49, 6-57
- combatant commander and, 1-49
 - considerations for, 6-51
 - CSS and, 12-27
 - decisive and shaping operations, 4-87
 - defensive execution and, 8-67
 - deliberate attacks and, 7-56
 - element of operational design, 5-44–5-47
 - example of, 1-50
 - massing effects and, 4-40
 - multiple lines of operations and, 5-34
 - nonlinear operations and, 5-50
 - tempo and, 5-51
- situational understanding, 4-28, 4-31, 5-9, 5-58, 7-78, 7-106–7-107, 7-108, 11-6, 11-28, 11-41–11-42, 11-71, 11-78
- COP and, 4-29
 - fires and, 1-18, 4-15
 - fratricide avoidance and, 4-27
 - information superiority and, 9-21, 11-3
 - massing effects and, 4-40
 - METT-TC and, 5-9
 - nonlinear operations and, 5-50
 - reorganization and, 6-49

- situational understanding (*continued*)
 relevant information and, 11-34, 11-82
 subject matter experts and, 11-76
 subordinate initiative and, 11-46
 visualization and, 5-54, 6-37
- SOF, 2-54
 capabilities of, 2-25
 counterterrorism and, 9-38
 role in MOOTW, 2-25
 surprise and, 7-11
- spoiling attack, 7-59, 7-60, 8-46
 defensive operations and, 8-10
 withdrawal and, 8-25
- SSC, ARFOR in, 2-39
 Army role in, 1-34, 9-3
 crisis and, 9-8
 modernized forces and, 3-4
 spectrum of conflict and, 1-47
 unified action and, 1-34
- stability operations, 1-48, 6-89
 asymmetry in, 4-113
 basic force and, 3-30
 characteristics of, 9-12–9-17
 close combat and, 4-10
 consequences of actions during, 9-53–9-54
 considerations for, 9-47–9-60, page 9-14
 CSS and, 12-32–12-33
 culminating point and, 5-39
 depth and, 4-63
 enemy and, 5-14
 information superiority and, 11-5
 initial-entry forces in, 3-48
 initiative, examples of, 4-56
 IO and, 4-63
 ISR and, 4-63
 local population, importance of, 5-22
- logical lines of operations and, 5-37
 METL development and, 3-35
 MTW and, 9-3, page 9-1
 nonlinear operations and, 5-48
 objective and, 4-36–4-37
 PME and, 1-11
 purpose of, 9-2, 9-18
 response and, 9-8–9-11
 SOF role in, 2-26
 spectrum of conflict and, 1-47
 tactical maneuver in, 4-8
 technology and, 1-39
 threat of force and, 6-24
 types of, 9-18–9-46, page 9-5
- staff tailoring, 3-32
- Stafford Act, 1-48, 10-5
- strategic lift, 3-2
 CSS and, 12-47
 forcible entry and, 3-54
 host nation support and, 12-18
 mission analysis and, 3-29
- strategic responsiveness, 3-2–3-5
 Army contribution to joint force capability, 1-12–1-13
 attributes of, 3-6–3-17
 considerations of, 3-18–3-38, page 3-5
 deterrence and, 3-5
 force tailoring and, 1-13, 3-5
 foundation of, 3-7
 information superiority and, 11-72
 ISR and, 11-75
 maneuver and, 1-12
 multiple lines of operations and, 5-34
 objective force and, 3-4
 operational success and, 3-5
 training and, 3-9, 3-10
- striking force, 8-16, 8-17, 8-19, 8-36, 8-67
- support (command relationship), 2-17, 2-35
- support operations, 1-48, 6-89, 10-1–10-44
 Army suitability for, 10-10–10-11
 asymmetry in, 4-113
 basic force and, 3-30
 characteristics of, 10-2
 considerations, 10-39–10-44
 coordination with nonmilitary groups, 10-40, 10-41, 10-42
 CSS and, 12-34–12-35
 CSS as decisive operation in, 4-85
 culminating point and, 5-39
 decisive points and, 5-32
 depth and, 4-63
 enemy, 5-14
 forms of, 10-12–10-37
 information superiority and, 11-5
 initial-entry forces in, 3-49
 initiative and, 4-57
 local population and, 5-22
 logical lines of operations and, 5-37
 METL development and, 3-35
 nonlinear operations and, 5-48
 objective and, 4-36–4-37
 purpose of, 10-1
 SOF role in, 2-26
 spectrum of conflict and, 1-47
 tactical maneuver in, 4-8
 technology and, 1-39
 types of, 10-3
- surprise, 4-47
 ambushes and, 7-64
 hasty attacks and, 7-55
 maneuver and, 4-43
 offensive operations and, 7-8, 7-9–7-12, 7-95
 operational-level, 7-10
 OPSEC and, 11-52
 results of, 7-9
 tactical-level, 7-10
 terrain and, 7-85

- surprise (*continued*)
 time available and, 7-91
- surveillance, 11-11, 11-18, 11-19–11-21, page 11-8. *See also* ISR
 defensive execution and, 8-67
 IPB and, 11-18
 noncontiguous AOs and, 7-26
 reconnaissance and, 11-23, 11-27
- survivability, 3-15–3-16, 4-29
 BOS, 5-66
 reconnaissance assets and, 11-24
- sustainability, 3-17, 12-6, 12-12, 12-14
 extension of, 12-46–12-48
 factors affecting, 12-50–12-61
 support base and, 12-16
- sustaining operations, 4-83, 4-90–4-92, 6-49, 6-60
 CSS and, 4-90, 12-3
 defensive operations and, 8-41–8-43, 8-71
 NBC operations and, 6-69
 nonlinear operations and, 5-49
 offensive operations and, 7-27, 7-90, 7-95, 7-97
 operational-level concerns, 4-92
 rear area and, 4-99
 tactical-level concerns, 4-92
- sustainment, 6-60
 force projection process, 3-40
 nonlinear operations and, 7-28
 offensive preparation and, 7-95
 operational reach and, 5-40
- synchronization, 4-65–4-66, 5-9, 5-41, 7-6, 8-34, 11-76
 achieving complementary and reinforcing effects, 4-108
 AO and, 4-74
 area defense and, 8-20
 counterattacks and, 7-61
 CSS and, 12-3
- defensive operations and, 8-37
- deliberate attacks and, 7-56
- elements of combat power and, 4-3
- fires and effects, 2-69–2-73, 4-15, 5-64, 7-33
- hasty attacks and, 7-54
- information sharing and, 1-38
- integration and, 12-6
- maneuver and firepower, 2-17, 5-65
- multinational operations and, 1-41
- multiple lines of operations and, 5-37
- operational framework and, 7-21
- reconstitution and, 6-87
- sustainment and, 12-6
- technology and, 7-106
- tempo and, 6-45, 7-18
- T**
- TACON, 2-30, 2-33
- tactical road march, 7-45, 8-32
- tactics, 2-7, 2-12, 5-7–5-8
- targeting, unified action considerations, 2-68–2-73
- task organization, 2-32, 2-33, 4-101, 7-46
- TCF, 4-90, 8-42, 8-70, page 4-23
- technology, 1-39–1-43
 CSS and, 12-62–12-63
 defensive operations and, 8-6, 8-76
 doctrine and, 1-45
 information superiority and, 11-82–11-86
 offensive operations and, 7-106–7-108
 soldiers and, 1-55
- tempo, 5-54, 6-59, 11-5, 11-82
 adversaries and, 1-28–1-29
 control of, 6-45
- CSS and, 7-90
- CSS reach and, 12-5
- defense and, 4-55
- digitized forces and, 1-41
- element of operational design, 5-54–5-56
- execution and, 7-98, 7-99, 7-101
- exploitation and, 7-71
- force sequencing and, 3-34
- fratricide avoidance and, 4-27
- initiative and, 4-51, 6-32
- information and, 11-82
- initiative and, 6-31
- maneuver and fires and, 7-19
- momentum and, 6-41
- offensive and, 4-38, 7-8, 7-17–7-19, 7-78, 12-28
- operational-level, 7-17
- safety and, 4-26
- surprise and, 7-12
- sustaining operations and, 4-92
- tactical-level, 7-17
- technology and, 7-108
- time available and, 7-91
- tenets of Army operations, 4-2, 4-50–4-68, 5-11
- TEP, 1-11, 2-25, 10-7, 9-10
- terrain, adversary use of, 1-29
 area defense and, 8-21
 characteristic of land combat, 1-36
 decisive, 7-86, 8-55
 decisive operations and, 7-22, 8-53–8-55, 8-62
 delay and, 8-31
 key, 7-84, 7-86, 8-21, 9-14
 METT-TC, factor of, 5-15
 mobile defense and, 8-17
 offensive planning and, 7-84–7-86
 operational-level considerations, 8-53
 seizing/securing, 7-2, 7-3

terrain (*continued*)
 stability operations and, 9-14
 urban operations and, 6-75
 terrain management, 4-90, 7-97, 8-41
 terrorism, 1-10, 9-37
 theater missile defense, 5-29, 5-68, 8-71
 theater of operations, 4-70, 4-72, 4-73
 theater of war, 4-70–4-72
 theater organization, 4-70–4-72
 threat, 1-25–1-29, 1-45, 6-74
 time available, defensive planning and, 8-58
 offensive planning and, 7-91–7-92
 METT-TC, factor of, 5-17
 stability operations and, 9-15
 Title 10 USC, 12-38, 12-45
 ADCON and, 2-29, 2-34,
 ARFOR commander and, 2-37
 ASCC commander and, 2-36, 2-37
 counterdrug operations and, 10-27
 armed forces functions and, 2-18
 HCA and, 9-33
 responsibilities, 2-34
 support requirements and, 2-34
 military support to civil law enforcement and, 10-24–10-31
 TPFDD, 3-25, 3-27, 3-34, 3-45, 3-47, page 3-15
 training, 1-51–1-52, 11-82
 after-action reports and, 6-95
 agility and, 3-12
 anticipation and, 3-19
 asymmetric attacks and, 4-114
 battle focused, 1-51–1-52
 civilian law enforcement officials and, 10-31
 commander and, 1-51

crisis and, 3-9
 defensive planning and, 8-57
 deployment and, 3-11
 field discipline and, 4-23, 4-24
 METL and, 1-52
 NBC operations and, 6-70–6-71
 PME and, 9-6
 possible scenarios and, 3-3
 precision and, 3-41
 reconstitution and, 6-84
 resource allocation and, 3-44
 responsiveness and, 3-9, 3-10
 safety and, 4-26
 stability operations and, 9-56
 strategic responsiveness consideration, 3-7, 3-35–3-37
 synchronization and, 3-42
 tempo and, 6-25
 unified action considerations, 2-76
 unit preparation and, 6-24–6-25
 versatility and, 3-13
 transitions, 6-81–6-83, 7-19
 troops and support available, 5-16, 7-88–7-89, 8-57, 9-14
 TSC, 1-21, 2-37, 2-41, 2-44, 12-9, 12-43
 turning movement, 7-35, 8-16, 8-55

U

unassisted entry, 3-50
 unified action, 2-1–2-2, 4-102.
See also joint operations
 Air Force and, 2-19–2-20
 Army METL and, 1-6
 Coast Guard and, 2-24
 COCOM and, 2-2
 conduct of, 2-15–2-60
 considerations for, 2-65–2-67
 cultural considerations and, 2-82–2-84
 doctrine and, 1-44

JFC role in, 1-32
 Marine Corps and, 2-21–2-23
 MTW and, 1-33
 multinational operations and, 2-1, 2-42–2-58
 national military strategy and, 1-32
 Navy and, 2-21–2-23
 operational environment and, 1-32–1-35
 political considerations, 2-78–2-81
 SOF and, 2-25–2-26
 SSCs and, 1-34
 military considerations, 2-66–2-77
 Unified Command Plan, 4-69
 unity of command, 2-48, 4-44–4-45
 unity of effort, 2-2, 2-15, 7-5, 9-48
 DSO and, 10-41
 FHA and, 10-41
 multinational operations and, 2-48–2-49
 unified action and, 2-78
 unity of command and, 4-45
 unopposed entry, 3-49
 urban operations, 1-29, 6-76–6-78

V

versatility, 3-13, 4-66–4-67
 achieving complementary and reinforcing effects, 4-108
 ARFOR, 2-37
 soldiers and, 1-53–1-54
 visualization, 3-21, 5-1, 5-6, 5-10–5-56, 12-9. *See also* commander's vision
 art of command and, 5-3
 battlespace changes and, 4-78
 commander's experience and, 5-54–5-55
 COP and, 5-53

visualization (*continued*)

elements of operational design
and, 5-24–5-25
execution and, 7-98
IPB and, 11-18
military decision making process
and, 11-36
METT-TC and, 5-9
operational framework and,
4-69
planning and, 5-60
support operations and, 10-2

W-X-Y-Z

withdrawal, 8-23–8-27, 8-30.

See *also* retrograde

WMD, 1-10, 1-40

adversary use of, 1-29

air defense and, 5-65

air defense artillery protection
of, 4-23

antiterrorism and, 9-39

arms control and, 9-43

Army capabilities and, 10-23

asymmetry and, 4-113, 4-115

decisive points, 5-31

defensive execution and, 8-72

force protection and, 4-21

measures for countering use
of, 6-69

multinational operations,
training for, 2-76

threat in force projection, 3-55

threat of, 1-27, 1-29, 6-66–
6-71, 8-13

use by terrorists, 9-37

FM 3-0
14 June 2001

By order of the Secretary of the Army:

ERIC K. SHINSEKI
General, United States Army
Chief of Staff

Official:

JOEL B. HUDSON
Administrative Assistant to the
Secretary of the Army
0115803

DISTRIBUTION:

Active Army, Army National Guard, and US Army Reserve: To be distributed in accordance with the initial distribution number 110512, requirements for FM 3-0 (formerly FM 100-5), *Operations*.

